

1. Package Contents

Thank you for purchasing PLANET Industrial 8-port 10/100/1000T 802.3af PoE + 2-port 100/1000X SFP Ethernet Switch, IGS-1020PTF or IGS-1020PTF-12V. The hardware specifications of these models are shown below:

Model Name	10/100/1000T 802.3af PoE+ RJ45 Ports	100/1000X SFP Slots	Power Input Range
IGS-1020PTF	8	2	DC 48~56V
IGS-1020PTF-12V			DC 12~56V

In the following sections, the term **"Industrial PoE+ Switch"** means the IGS-1020PTF or IGS-1020PTF-12V.

Open the box of the Industrial PoE+ Switch and carefully unpack it. The box should contain the following items:

Industrial PoE+ Switch x 1	User's manual x 1
Wall-mount kit x 1	DIN-rail kit x 1
RJ45 Dust Caps x 8	SFP Dust Caps x 2

If any of these are missing or damaged, please contact your dealer immediately; if possible, retain the carton including the original packing material, and use them again to repack the product in case there is a need to return it to us for repair.

Gigabit SFP Slots (Port 9 to Port 10)

100/1000BASE-X mini-GBIC slot, SFP (small factor pluggable) transceiver module: From 550 meters (multi-mode fiber) to 10/20/30/40/50/60/70/120 kilometers (single-mode fiber).

DIP Switch for Port 5 to Port 8

The Industrial PoE+ Switch has a built-in solid DIP switch that provides **"Standard"** and **"Extend"** operation modes. The Industrial PoE+ Switch operates as a normal IEEE 802.3af/at PoE+ Switch in the **"Standard"** operation mode.

In the **"Extend"** operation mode, Port 5 to Port 8 of the Industrial PoE+ Switch operates on a per-port basis at 10Mbps full duplex operation but can support 20~25-watt PoE power output over a distance of up to 250 meters overcoming the 100m limit on Ethernet UTP cable. With this brand-new feature, the Industrial PoE+ Switch provides an additional solution for 802.3af/at PoE+ distance extension.

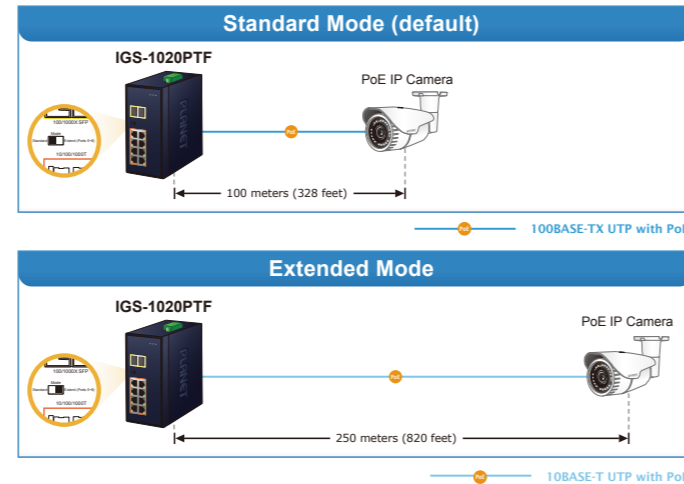

60W	Amber	Off: Indicates the PoE usage is less than 30W. Blinks: Indicates that the PoE usage is around 30W to 59W. Lights: Indicates the PoE usage is around/over 60W.
120W	Amber	Blinks: Indicates that the PoE usage is around 60W to 119W. Lights: Indicates the PoE usage is around/over 120W.
180W	Amber	Blinks: Indicates that the PoE usage is around 120W to 179W. Lights: Indicates the PoE usage is around/over 180W.
240W	Amber	Blinks: Indicates that the PoE usage is around 180W to 239W. Lights: Indicates the PoE usage is at the maximum.

Per 802.3af PoE+ 10/100/1000BASE-T Interface (Port 1 to Port 8)

LED	Color	Function
LNK/ACT	Green	Lights: Indicates the link through that port is successfully established at 10Mbps, 100Mbps or 1000Mbps. Blinks: Indicates that the switch is actively sending or receiving data over that port.
PoE - in-Use	Amber	Lights: Indicates the port is providing DC in-line power. Off: Indicates the connected device is not a PoE powered device (PD).

Figure 2-4 shows the upper panel of the IGS-1020PTF-12V.

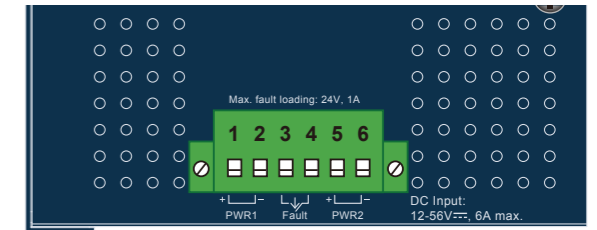

Figure 2-4: IGS-1020PTF-12V Upper Panel

2.4 Wiring the Power Inputs

The 6-contact terminal block connector on the top panel of Industrial PoE+ Switch is used for two DC redundant power inputs. Please follow the steps below to insert the power wire.

Caution When performing any of the procedure like inserting the wires or tightening the wire-clamp screws, make sure the power is OFF to prevent from getting an electric shock.

1. Insert positive and negative DC power wires into Contacts 1 and 2 for Power 1, or Contacts 5 and 6 for Power 2.

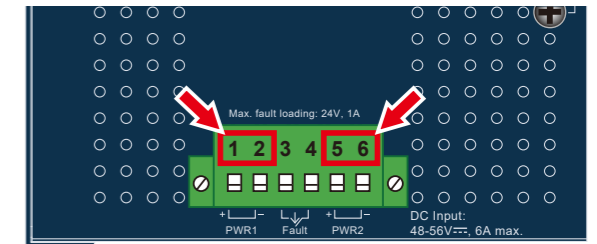

2. Hardware Introduction

2.1 Switch Front Panel

The front panels of the Industrial PoE+ Switches consist of Ethernet interfaces and LED indicators as shown below:

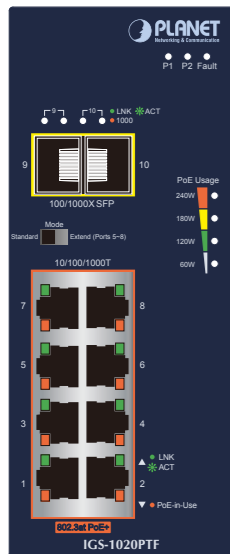

Figure 2-1: IGS-1020PTF front panel

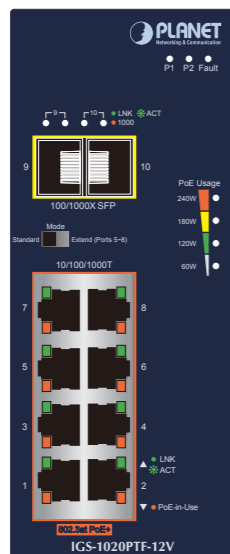

Figure 2-2: IGS-1020PTF-12V front panel

Gigabit TP Interfaces (Port 1 to Port 8)

10/100/1000BASE-T copper, RJ45 twisted-pair: Up to 100 meters in standard mode.

DIP Switch Mode	Function
<p>Standard</p>	<p>DIP switch is off</p> <p>This mode makes the Industrial PoE+ Switch operate as a general switch and all PoE ports operate at 10/100/1000Mbps auto-negotiation.</p>
<p>Extended</p>	<p>DIP switch is on</p> <p>This mode makes Port 5 to Port 8 of the Industrial PoE+ Switch operate on a per-port basis at 10Mbps full duplex operation but can support PoE power output over a distance of up to 250 meters overcoming the 100m limit on Ethernet UTP cable.</p>

***Note:** After changing the DIP switch mode, please reboot the switch to take effect.

2.2 LED Indicators System

LED	Color	Function
P1	Green	Lights: Indicates power 1 has power.
P2	Green	Lights: Indicates power 2 has power.
FAULT	Red	Lights: Indicates either power 1 or power 2 has no power.

Per 100/1000X SFP Slot (Port 9 to Port 10)

LED	Color	Function
LNK/ACT	Green	Lights: Indicates the link through that port is successfully established at 1000Mbps or 100Mbps. Blinks: Indicates that the switch is actively sending or receiving data over that port.
1000	Amber	Lights: Indicates the link through that port is successfully established at 1000Mbps. Off: Indicates the link through that port is not established or is established at 100Mbps.

2.3 Switch Upper Panel

The upper panel of the Industrial PoE+ Switch consists of one terminal block connector within two power input and one relay output.

Figure 2-3 shows the upper panel of the IGS-1020PTF.

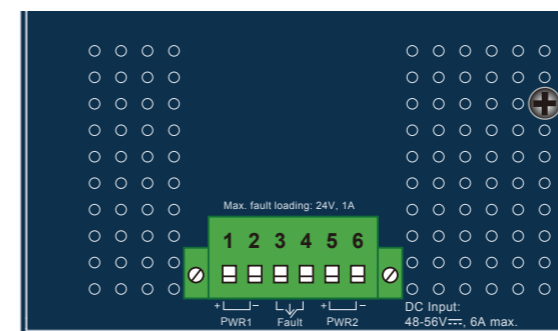
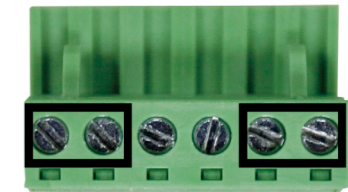

Figure 2-3: IGS-1020PTF Upper Panel

2. Tighten the wire-clamp screws for preventing the wires from loosening.



1 2 3 4 5 6
Power 1 Fault Power 2
+ - + -

1. The wire gauge for the terminal block should be in the range between 12 ~ 24 AWG.
2. The **IGS-1020PTF-12V** supports DC input range of 12V to 56V. To avoid damage, please use the IGS-1020PTF-12V under its specification.

Note

DC Input	Max. PoE Budget
12V	60W
24V	120W
48V	240W

2.5 Wiring the Fault Alarm Contact

The fault alarm contacts are in the middle of the terminal block connector as the picture shows below. Inserting the wires, the Industrial PoE+ Switch will detect the fault status of the power failure and then forms an open circuit. The following illustration shows an application example for wiring the fault alarm contacts.

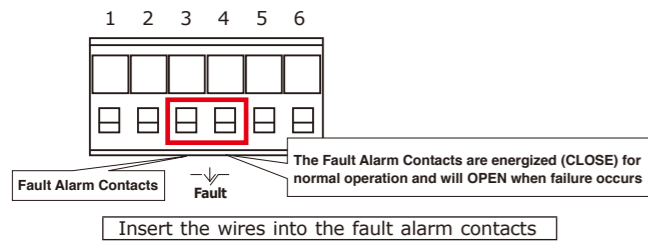

- Note**
1. The wire gauge for the terminal block should be in the range between 12 and 24 AWG.
 2. Alarm relay circuit accepts up to 24V with a maximum current of 1A.

2.6 Grounding the Device

Users **MUST** complete grounding wired with the device; otherwise, a sudden lightning could cause fatal damage to the device.

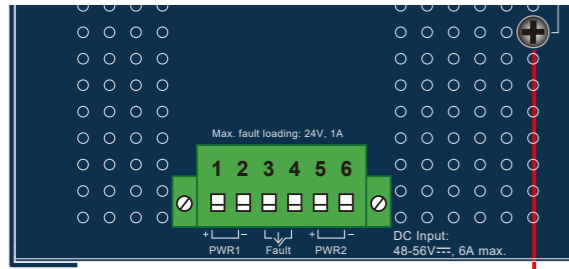

- Note**
- EMD (Lightning) DAMAGE IS NOT COVERED UNDER WARRANTY.

3.3 Side Wall-mount Plate Mounting (for IGS-1020PTF only)



4. Product Specifications

Model	IGS-1020PTF	IGS-1020PTF-12V
Hardware Specifications		
Copper Ports	8 10/100/1000BASE-T RJ45 auto-MDI/MDI-X ports	
PoE Injector Ports	8 ports with 802.3at PoE+ injector function (Port 1 to Port 8)	
SFP Slots	2 1000BASE-SX/LX/BX SFP interfaces (Port 9 and Port 10) Compatible with 100BASE-FX SFP	
Connector	Removable 6-pin terminal block Pin 1/2 for Power 1; Pin 3/4 for fault alarm; Pin 5/6 for Power 2	
DIP Switch	Standard/Extend mode (Extend mode for Port 5 to Port 8 only)	

ESD Protection	6KV	
Switch Specifications		
Switch Architecture	Store-and-Forward	
Switch Fabric	20Gbps	
Throughput (packet per second)	14.8Mpps@64bytes	
Address Table	8K entries	
Buffer Memory	4M bits on-chip buffer memory	
Jumbo Frame	9Kbytes	
Flow Control	Back pressure for half duplex IEEE 802.3x pause frame for full duplex	
Power over Ethernet		
PoE Standard	IEEE 802.3at Power over Ethernet Plus/PSE	
PoE Power Supply Type	End-span	
Power Pin Assignment	1/2 (+), 3/6 (-)	
PoE Power Output	Per port 48~56V DC Max. 30 watts	Per port 54V DC Max. 30 watts
PoE Power Budget (max.)	240W maximum	240W maximum@54V DC 120W maximum@24V DC 60W maximum@12V DC
Max. Number of Class 3 PDs@25W	8	

3. Installation

This section describes the functionalities of the Industrial PoE+ Switch's components and guides you to installing it on the DIN-rail and wall. Basic knowledge of networking is assumed. Please read this chapter completely before continuing.

- Note**
- The installation procedures of the IGS-1020PTF and IGS-1020PTF-12V are the same as they are shown below.

3.1 DIN-rail Mounting Installation



3.2 Wall-mount Plate Mounting



LED Indicators	3 x LED for System and Power: <ul style="list-style-type: none"> ● Green: DC Power 1 ● Green: DC Power 2 ● Red: Power Fault Alarm 8 x LED for PoE Copper Port (Port 1 to Port 8): <ul style="list-style-type: none"> ● Green: LNK/ACT (10/100/1000Mbps) ● Amber: PoE-in-Use 2 x LED for 100/1000X Fiber Port (Port 9 to Port 10): <ul style="list-style-type: none"> ● Green: LNK/ACT (100/1000Mbps) ● Amber: 1000Mbps 4 x LED for PoE Usage <ul style="list-style-type: none"> ● Amber: 60W, 120W, 180W and 240W 	
Power Requirements	48~56V DC, 6A (max.)	12~56V DC, 6A (max.)
Power Consumption	Max. 3.92 watts/13BTU@56V DC input (System) Max. 7.28 watts/24BTU@56V DC input (Ethernet Full Loading) Max. 251.2 watts/857BTU@56V DC input (Ethernet + PoE Full Loading)	Max. 5.6 watts/19BTU@56V DC input (System) Max. 8.4 watts/29BTU@56V DC input (Ethernet Full Loading) Max. 252.1 watts/860BTU@56V DC input (Ethernet + PoE Full Loading)
Dimensions (W x D x H)	66 x 106 x 152 mm	77 x 106 x 152mm
Weight	879g	1164g
Enclosure	IP30 metal case	IP30 aluminum case
Installation	DIN-rail/wall-mount/side wall-mount	DIN-rail/wall-mount

Standards Conformance	
Regulatory Compliance	FCC Part 15 Class A, CE
Stability Testing	IEC 60068-2-32 (free fall) IEC 60068-2-27 (shock) IEC 60068-2-6 (vibration)
Standards Compliance	IEEE 802.3 Ethernet IEEE 802.3u Fast Ethernet IEEE 802.3ab Gigabit Ethernet IEEE 802.3z Gigabit Ethernet over Fiber Optic IEEE 802.3az Energy Efficient Ethernet (EEE) IEEE 802.3at Power over Ethernet Plus IEEE 802.3af Power over Ethernet
Environment	
Temperature	Operating: -40~75 degrees C Storage: -40~85 degrees C
Humidity	Operating: 5~90% (non-condensing) Storage: 5~90% (non-condensing)

Industrial 8-Port 10/100/1000T 802.3at PoE + 2-Port 100/1000X SFP Ethernet Switch

IGS-1020PTF Series



5. Customer Support

Thank you for purchasing PLANET products. You can browse our online FAQ resource at the PLANET Web site first to check if it could solve your issue. If you need more support information, please contact PLANET support team.

PLANET online FAQs:
<https://www.planet.com.tw/en/support/faq?method=category&c1=3>

Support team mail address:
support@planet.com.tw

Copyright © PLANET Technology Corp. 2020.
Contents are subject to revision without prior notice.
PLANET is a registered trademark of PLANET Technology Corp.
All other trademarks belong to their respective owners.

PLANET Technology Corp.
10F., No. 96, Minquan Rd., Xindian Dist., New Taipei City 231, Taiwan

Warning:
This device is compliant with Class A of CISPR 32.
In a residential environment this device may cause radio interference.
2350-AH5030-000

