



Product Catalog
ATEN SOHO and SMB Solutions



2019 | 2020

Celebrating 40 Years

2019 marks ATEN's 40th anniversary since the company was established in 1979. ATEN's success is anchored upon our dedication to AV/IT technologies, and our commitment to sustained innovation and achieving excellence, all fueled by a passion for bringing better connectivity to the world. We will continue to enjoy a solid base of market diversity, geographical expansion, and numerous achievements in alliance with our highly respected clients and partners.

As an accelerator for the integration of AV and IT technologies, ATEN works consistently to create secure, efficient, and productive IP-based AV networking and IT control solutions. Offering integrated KVM, professional AV, and intelligent power solutions, ATEN products connect, manage, and optimize AV/IT equipment in corporate, government, education, broadcasting and media, and transportation environments.



ATEN Product Portfolio

- ATEN's Altusen™ Enterprise Solutions for IT infrastructure access and management offer integrated KVM connectivity and control capabilities for customers to facilitate the effective management of IT infrastructures from anywhere in the world.
- ATEN's VanCryst™ Professional AV Solutions leverage our enhanced video and control capabilities and offer signal management and system control components to build a multitude of flexible integrated solutions for all professional audio/video-related applications.
- ATEN's SOHO/SMB Solutions invite you to experience the very latest standards in USB connectivity, mobility, and speed while embracing the next generation of 4K-enabled workstation solutions.
- ATEN's NRGence™ Energy Intelligence solutions offer sensor-enabled, energy-saving hardware and software for data centers that provide real-time energy management and performance indicators.

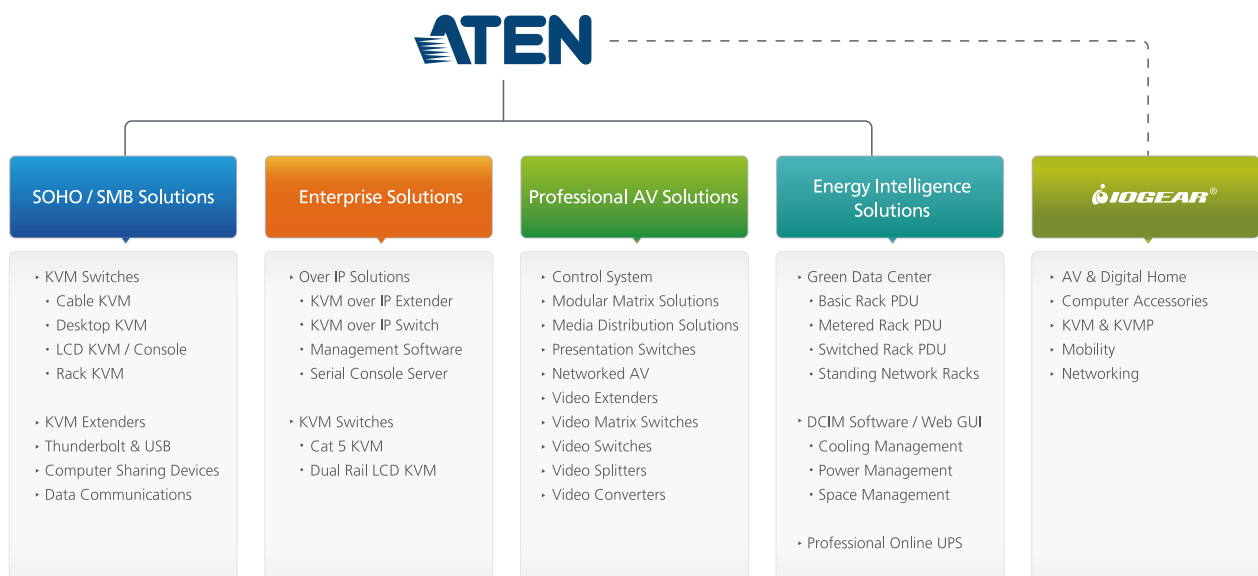

Contents

Introduction	I	Company Profile	
	III	Basic KVM	
	IV	The Latest Patented Technology from ATEN	
Rack KVM Switches	1-3	8 /16-Port USB HDMI/Audio KVM Switch	CS1798 / CS17916
	1-5	8-Port USB DVI Dual Link/Audio KVM Switch	CS1788
	1-7	8-Port USB DVI/Audio KVM Switch	CS1768
	1-9	4 / 8-Port PS/2-USB VGA/Audio KVM Switch	CS1754 / CS1758
	1-10	8 / 16-Port PS/2-USB VGA KVM Switch	CS1308 / CS1316
	1-11	8 / 16-Port PS/2-USB VGA KVM Switch with Daisy-Chain Port and USB Peripheral Support	CS1708A / CS1716A
	1-12	16-Port PS/2 VGA KVM Switch with Daisy-Chain Port	ACS1216A
	1-13	4 / 8-Port PS/2 VGA KVM Switch	CS9134 / CS9138
KVM over IP Switches	2-3	1-Local / Remote Share Access Single Port VGA KVM over IP Switch (1920 x 1200)	CN8000A
	2-4	1-Local / Remote Share Access Single Port DVI KVM over IP Switch (1920 x 1200)	CN8600
	2-5	1-Local / Remote Share Access 8 / 16-Port PS/2-USB VGA KVM over IP Switch	CS1708I / CS1716I
Secure KVM Switches	3-1	2 / 4 / 8-Port USB DVI / HDMI / DisplayPort Single / Dual Display Secure KVM Switch	PSS PP v3.0 Secure KVM Switch Series
LCD KVM Switches	4-5	8 / 16-Port PS/2-USB VGA LCD KVM over IP Switch with Daisy-Chain Port and USB Peripheral Support	CL5708I / CL5716I
	4-7	1U Ultra Short Depth Dual Rail WideScreen LCD Console with USB Peripheral Support (USB / HDMI / DVI / VGA)	CL3800
	4-8	1U Ultra Short Depth Single Rail WideScreen LCD Console with USB Peripheral Support (USB / HDMI)	CL3700
	4-9	1U Ultra Short Depth Single Rail WideScreen LCD Console with USB Peripheral Support (USB / VGA)	CL3100
	4-10	Single Rail WideScreen Full HD LCD Console with USB Peripheral Support (USB / HDMI / DVI / VGA)	CL6700
	4-11	Lightweight PS/2-USB VGA LCD Console with USB Peripheral Support	CL3000
	4-12	PS/2-USB VGA Dual Rail LCD Console with USB Peripheral Support	CL5800
	4-13	17" / 19" PS/2 VGA LCD Console	CL1000
	4-14	8-Port DVI Full HD LCD KVM Switch	CL6708
	4-15	8 / 16-Port PS/2-USB VGA LCD KVM Switch	CL1308 / CL1316
	4-16	8 / 16-Port PS/2-USB VGA Dual Rail LCD KVM Switch with Daisy-Chain Port and USB Peripheral Support	CL5808 / CL5816
	4-17	8 / 16-Port PS/2-USB VGA LCD KVM Switch with Daisy-Chain Port and USB Peripheral Support	CL5708 / CL5716
	4-19	8 / 16-Port PS/2 VGA LCD KVM Switch with Daisy-Chain Port	CL1008 / CL1016
	KVM Extenders	5-5	USB DisplayPort HDBaseT 2.0 KVM Extender (4K@100m)
5-6		USB HDMI HDBaseT 2.0 KVM Extender (4K@100m)	CE820
5-7		USB DVI Dual View HDBaseT 2.0 KVM Extender (1920 x 1200@100m)	CE624
5-8		USB DVI HDBaseT 2.0 KVM Extender (1920 x 1200@100m)	CE620
5-9		Mini USB DVI HDBaseT KVM Extender (1920 x 1200@100m)	CE611
5-10		USB DVI HDBaseT KVM Extender with ExtremeUSB® (1920 x 1200@100m)	CE610A
5-11		USB DVI Optical KVM Extender (1920 x 1200@600m) / (1920 x 1200@20km)	CE680 / CE690
5-12		USB DVI Dual View Cat 5 KVM Extender (1024 x 768@60m)	CE604
5-13		USB DVI Cat 5 KVM Extender / USB DVI Dual Link Cat 5 KVM Extender (1024 x 768@60m)	CE600 / CE602
5-14		USB VGA/Audio Cat 5 KVM Extender (1024 x 768@250m)	CE800B
5-15		USB VGA Dual View Cat 5 KVM Extender (1600 x 1200@150m) / USB VGA Dual View Cat 5 KVM Extender with Deskew (1280 x 1024@300m)	CE774 / CE775

Contents

KVM Extenders

5-16	USB VGA/Audio Cat 5 KVM Extender with Deskew (1280 x 1024@300m)	CE770
5-17	USB VGA/Audio Cat 5 KVM Extender (1280 x 1024@200m)	CE750A
5-18	USB VGA Cat 5 KVM Extender (1280 x 1024@150m)	CE700A
5-19	USB VGA Cat 5 Mini KVM Extender (1280 x 1024@100m)	CE100
5-20	PS/2 VGA/Audio Cat 5 KVM Extender (1600 x 1200@150m) / PS/2 VGA/Audio Cat 5 KVM Extender with Deskew (1280 x 1024@300m)	CE350 / CE370
5-21	PS/2 VGA Cat 5 KVM Extender (1280 x 1024@150m)	CE250A
5-23	305M HDBaseT SF/UTP Cat 6 Cable	2L-2910
5-25	305M Low Skew Cat 5e Cable	2L-2801

Cable KVM Switches

6-4	Laptop USB KVM Console Crash Cart Adapter	CV211
6-5	2-Port USB DisplayPort Cable KVM Switch with Remote Port Selector	CS22DP
6-6	2-Port USB HDMI/Audio Cable KVM Switch with Remote Port Selector	CS692
6-7	2-Port USB DVI/Audio Cable KVM Switch with Remote Port Selector	CS682
6-8	2-Port USB DVI Cable KVM Switch with Remote Port Selector	CS22D
6-9	2-Port USB VGA/Audio Cable KVM Switch	CS62U / CS62US
6-10	4-Port USB VGA/Audio Cable KVM Switch	CS64U / CS64US
6-11	2-Port USB VGA Cable KVM Switch with Remote Port Selector	CS22U
6-12	2-Port PS/2 USB VGA/Audio Cable KVM Switch with Remote Port Selector	CS52A
6-13	2-Port PS/2 USB VGA Cable KVM Switch with Remote Port Selector	CS52
6-14	2-Port PS/2 VGA Cable KVM Switch	CS62S
6-15	2/4-Port PS/2 VGA/Audio Cable KVM Switch	CS62A / CS64A

Desktop KVM Switches

7-5	4-Port USB 4K HDMI Multi-View KVMP™ Switch	CM1284
7-7	4-Port USB DVI Multi-View KVMP™ Switch	CM1164A
7-9	4-Port USB Boundless KM Switch	CS724KM
7-10	3-Port USB-C DisplayPort KVMP™ Switch	CS1953
7-11	4-Port USB 3.0 4K DisplayPort Triple Display KVMP™ Switch	CS1964
7-12	2 / 4-Port USB 3.0 4K DisplayPort Dual Display KVMP™ Switch	CS1942DP / CS1944DP
7-13	2 / 4-Port USB 3.0 4K DisplayPort/Audio MST KVMP™ Switch	CS1922M / CS1924M
7-15	2/4-Port USB 3.0 4K DisplayPort KVMP™ Switch	CS1922 / CS1924
7-17	2/4-Port USB 3.0 DisplayPort/Audio KVMP™ Switch	CS1912 / CS1914
7-19	2-Port USB DisplayPort/Audio KVM Switch (4K supported)	CS782DP
7-21	2/4-Port USB 3.0 4K HDMI KVMP™ Switch with Audio Mixer	CS1822 / CS1824
7-22	2/4-Port USB HDMI/Audio KVMP™ Switch	CS1792 / CS1794
7-23	2/4-Port USB DVI Dual Link Dual Display/Audio KVMP™ Switch	CS1642A / CS1644A
7-24	2/4-Port USB DVI Dual Link/Audio KVMP™ Switch	CS1782A / CS1784A
7-26	2/4-Port USB DVI/Audio KVMP™ Switch	CS1762A / CS1764A
7-27	2-Port USB DVI/Audio Slim KVM Switch	CS72D
7-28	2/4-Port USB VGA Dual Display/Audio KVMP™ Switch	CS1742 / CS1744
7-29	2/4-Port PS/2-USB VGA/Audio KVMP™ Switch with OSD	CS1732B / CS1734B
7-30	2/4-Port PS/2-USB VGA/Audio KVMP™ Switch	CS1732A / CS1734A
7-31	2/4-Port PS/2-USB VGA KVM Switch	CS82U / CS84U
7-32	2/4-Port USB VGA/Audio KVM Switch	CS72U / CS74U
7-33	2/4-Port PS/2 VGA KVM Switch	CS82A / CS84A
7-34	4-Port PS/2 VGA Slim KVM Switch	CS74E

Contents

Computer Sharing Devices	8-1	USB DVI Computer Sharing Device	CS261	
	8-2	USB VGA Computer Sharing Device	CS231	
KVM Modules & Included Accessories	9-2	PS/2 Emulator	CV100KM	
	9-2	PS/2 to USB Adapter (90 cm)	UC10KM	
	9-3	PS/2 to USB Adapter with Mac support (30 cm)	UC100KMA	
Thunderbolt & USB Docking Stations	10-4	USB-C Multiport Mini Dock with Power Pass-Through	UH3236	
	10-5	USB-C Multiport Dock with Power Pass-Through (13")	UH3234	
	10-7	USB-C Multiport Dock with Power Pass-Through (15")	UH3237	
	10-8	USB-C Multiport Dock with Power Charging	UH3230	
	10-9	USB-C Dual-DisplayPort Mini Dock	UH3231	
	10-10	USB-C Multiport Mini Dock	UH3232	
	10-11	USB-C Dual-HDMI Mini Dock	UH3233	
	10-12	Thunderbolt™ 3 Multiport Dock with Power Charging	UH7230	
	Docking Switches	10-13	2-Port USB 3.1 Gen 1 Type-C Dock Switch with Power Pass-Through	US3310
		10-14	2-Port ThunderBolt™ 2 KVM Docking Station	US7220
Converters	10-17	CAMLIVE™ (HDMI to USB-C UVC Video Capture)	UC3020	
	10-18	USB-C to 4K HDMI Cable (2.7 m)	UC3238	
	10-18	USB-C to 4K HDMI Adapter	UC3008	
	10-19	USB-C to VGA Adapter	UC3002	
	10-19	USB to RS-422/485 Adapter	UC485	
	10-20	USB to RJ-45 (RS-232) Console Adapter	UC232B	
	10-20	USB to RS-232 Adapter (35 cm) / USB to RS-232 Adapter (100 cm)	UC232A / UC232A1	
	10-21	2 / 4-Port USB to RS-232 Hub	UC2322 / UC2324 /	
	10-22	2 / 4-Port USB to RS-485 / 422 Hub	UC4852 / UC4854	
	10-22	USB to IEEE1284 Printer Adapter (1.8 m)	UC1284B	
Gamepad Emulator	10-23	PHANTOM-S™ (Gamepad Emulator for PS4 / PS3 / Xbox 360 / Xbox One)	UC3410	
Switches	10-25	USB-C Sharing Switch with Power Pass-through	US3342	
	10-26	4x4 USB 3.1 Gen 1 Industrial Switch	US3344I	
	10-27	2x4 / 4x4 USB 3.1 Gen 1 Peripheral Sharing Switch	US234 / US434 / US3324 / US3344	
	10-28	2x4 / 4x4 USB 2.0 Peripheral Sharing Switch	US224 / US424	
	10-29	2 / 4-Port USB 2.0 Peripheral Sharing Switch	US221A / US421A	
Extenders	10-30	10 m USB 3.1 Gen 1 Extender Cable / 15 m USB 3.1 Gen 1 Extender Cable	UE3310 / UE3315	
	10-30	5 m USB 3.1 Gen 1 Extender Cable	UE350A	
	10-31	5 m USB 2.0 Extender Cable (Daisy-chaining up to 25 m)	UE250	
	10-31	5 m USB Extender Cable (Daisy-chaining up to 25 m)	UE150	
	10-32	12 m USB 2.0 Extender Cable (Daisy-chaining up to 60 m) / 12m 4-port USB 2.0 Extender Cable (Daisy-chaining up to 60 m)	UE2120 / UE2120H	

Contents

Thunderbolt & USB Extenders	10-32	USB 2.0 Cat 5 Extender (up to 60 m)	UCE260
	10-33	USB Cat 5 Extender (up to 60 m)	UCE60
	10-33	4-Port USB 2.0 Cat 5 extender (up to 50 m)	UCE3250
	10-34	4-Port USB 2.0 Cat 5 Extender over LAN / 4-Port USB 2.0 Cat 5 Extender over LAN (Multi-Link Extension)	UEH4102 / UEH4112
	10-34	4-Port USB 2.0 Cat 5 Extender	UEH4002A
USB Hubs	10-35	4-Port USB 2.0 Hub / 4-Port USB 2.0 Hub with Magnetic	UH275 / UH284
Data Communication Printer Network	11-3	Non-Powered / High Speed Parallel Data Extender	IC164
Industry Controls	11-4	RS-232 / RS-485 Interface Converter	IC485S / IC485SI / IC485SN
	11-5	RS-232 to RS-422 / RS-485 Isolated Converter	IC485AI
	11-6	RS-232 8-Port PCI Card	IC-108S
Reference			
Cables	12-1		
Accessories	12-4		
Product Compatibility List	12-4		
Hotkeys	12-5		

Note: Product features and illustrations may have been updated since this catalog was printed. Please visit our website to obtain the latest information.

Company Profile

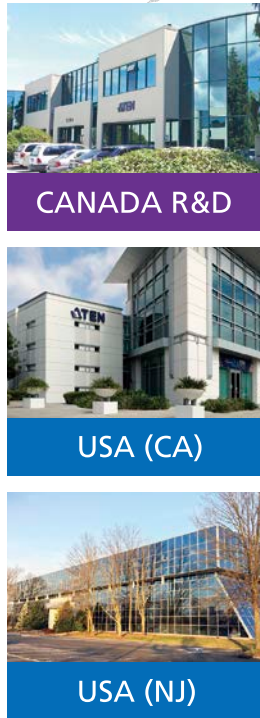

- Corporate Headquarters
- Subsidiaries and Regional Offices
- R&D Centers
- Manufacturing Facilities

Our Services for You

We help you satisfy all your customers' needs and grow your business.



Global Sales and Service Network

ATEN has a global network of sales and engineering professionals to provide our customers with fast, efficient, and comprehensive service. Our distribution channels and partners extend worldwide to more than 100 countries.



ATEN eNews

ATEN eNews is a monthly publication featuring the latest ATEN product developments, marketing and promotional resources, and corporate activities. Registered partners receive a monthly newsletter to stay up-to-date with ATEN's latest product news and events.



ATEN Download Center

As an ATEN partner, you are guaranteed to have all the tools, knowledge, and support you require to succeed. Authorized partners can access our intuitive information sharing platform to get the latest marketing materials, sales tools, technical documents, product certifications, and more. ATEN also provides integrated marketing programs and promotions to assist partners in promoting ATEN products and services.



ATEN Partner Portal

The ATEN Partner Portal is a web portal that is dedicated to Solution Partners, Channel Partners, and DMR Partners, and provides several ATEN online services, including technical support, product registration, and a wide range of unique partner services.

Basic KVM

What is a KVM Switch?

KVM stands for “Keyboard, Video and Mouse”. A KVM switch allows you to control multiple computers from a single keyboard, monitor and mouse (Console).

By using a KVM switch, you will save money on redundant hardware, consolidate desk space, and increase performance by having multiple computers working as one.

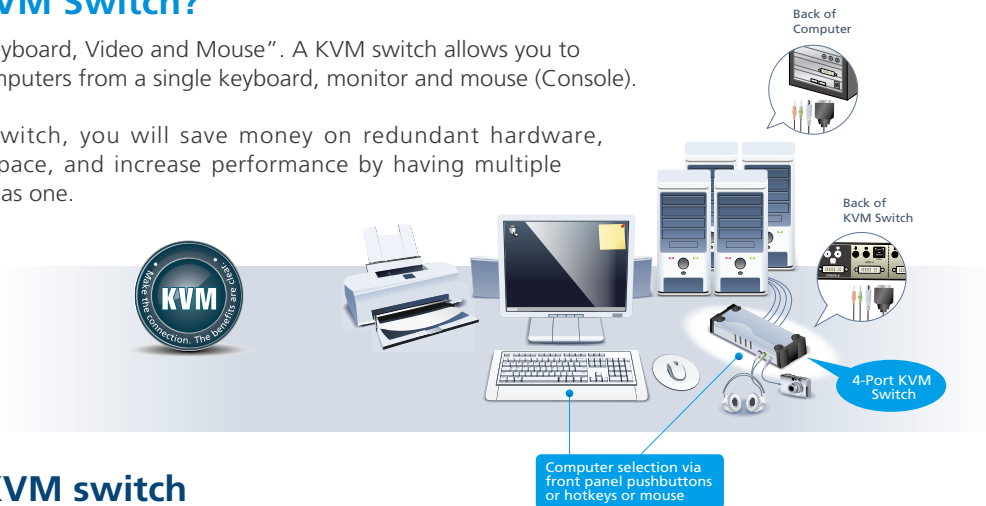

Advanced KVM switch

1. Managing Multiple Servers

Additional KVM switches can increase the overall capacity of your installation. There are two methods for expanding your KVM switch installation: cascading, and daisy-chaining.

Cascading

Cascading involves using the KVM port(s) of a “parent” KVM switch (one that is above a switch linked down from it) to connect to the console ports of a “child” KVM switch. With numerous child switches linked down from the parent, the effect is reminiscent of the way water cascades down a waterfall. Cascading adds capacity to a KVM installation, but the parent KVM switch loses at least one KVM port for each cascaded child switch.

Daisy-chaining

Daisy-chaining refers to connecting two KVM switches via dedicated daisy-chain ports. The switches are strung together in a chain, similar to the way children make chains of daisies by tying the end of one daisy to the head of another.

A daisy-chained installation does not utilize KVM ports or user ports to connect one switch to another as in a cascaded installation and thereby preserves the number of valuable ports. The port capacity of a daisy-chained installation is the total of all the KVM ports for all of the KVM switches on the chain.

Cascading

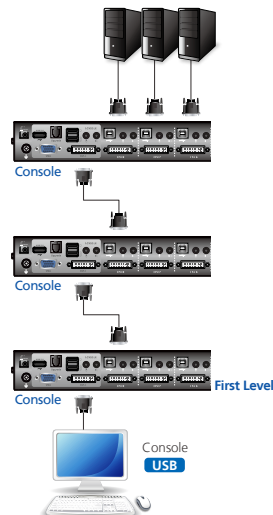

CS1768
8-Port DVI KVM Switch

Daisy-chaining

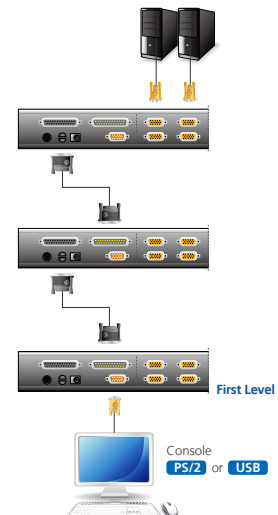

CS1716A
16-Port KVM Switch

The Latest Patented Technology from ATEN

• All-in-One

ATEN's patented all-in-one custom KVM cables were the first in the industry to offer such technology built directly into a KVM switch. The all-in-one design provides the perfect solution for accessing and sharing 2 or 4 computers in a SOHO or Digital Living Room environment. Its integrated design and small footprint allow it to be placed in a convenient, out-of-the-way location so that it doesn't negatively impact the room's decor.

Products: All Cable KVM Switches.

• KVMP™

KVMP™ is a patented ATEN technology that provides the industry's first full-functioning USB hub to be integrated into a KVM switch, allowing peripherals to be shared. KVMP™ provides centralized control of both computers and USB peripherals from a single console. KVMP™ switches are platform independent and allow you to access different PCs while maintaining peripheral focus on the original computer.

Products: Most Desktop KVM Switches.

• Video DynaSync™

Video DynaSync™ is a patented ATEN technology that optimizes your KVM viewing experience. By storing the console monitor's EDID, boot-up display problems are eliminated and operation is smoother thanks to the switch's ability to automatically show the correct display resolution when switching between ports. Video DynaSync™ ensures that your ideal video settings are maintained under all operating systems and is compatible with any OS operating system.

Products: Most KVMP™, KVM and Cable KVM Switches.

• Boundless Switching

Boundless Switching is a patented ATEN technology that allows users to switch KVM focus between multiple computers by moving the mouse cursor across the display or window borders. The mouse cursor can be moved to another display / window in any direction and, depending on your display setup, will switch the KVM focus to that display.

Products: CM1284, CM1164A, CS724KM

• Deskew

ATEN's patented automatic delay line synchronizing function corrects the color phase and time errors that can occur when RGB video signals are sent long distances over Cat 5e/6 cables. ATEN's Deskew technology enables you to manually tune the RGB signal settings, ensuring stable, high-quality video in both KVM and video extender installations.

Products: CE775, CE770, CE370 KVM Extender.

• Auto Switch

The ATEN US221A / US421A has an Auto Switch function that stores commands sent to the USB peripheral device to be processed on a first-come, first-served basis. This patented technology means that a separate print server is not required in your multifunction printer / USB peripheral installation.

Products: US221A / US421A USB 2.0 Peripheral Switch.

• Mouse DynaSync™

Mouse DynaSync™ is a patented ATEN technology that represents the latest in KVM mouse synchronization. With USB mice and Mouse DynaSync™, your local console mouse movement actually becomes the remote unit's mouse movement. The Mouse DynaSync™ technology automatically locks in the local and remote mouse pointers so that you do not waste time re-synching the two movements.

Products: CN8000A, CN8600, CS1708I / CS1716I (as well as various KVM over IP Products), CL5708I / CL5716I

• ATEN Exclusive Video Compensation Technology

ATEN's patented exclusive video compensation technology permits video signals to be transmitted over long distances with enhanced accuracy. The exclusive new technology improves on the previous design by minimizing inaccuracy from 10 m to only 1 m. This technology not only improves brightness, it also achieves high skew tolerance for our KVM extender products.

Products: CE350, CE370, CE100, CE770, CE774, CE775



Rack KVM Switches

1

Rack KVM Switches

Rack-mountable KVM switches are designed to meet the needs of moderate to large-sized business installations, streamlining PC and server management while easily accommodating upgrading and expansion. The series offers rack-mountable KVM switches ideal for server rooms, data centers, ISPs and test labs.



- **Flexible Expansion**

ATEN Rack KVM switches allow you to easily add up to 512 servers to your installation via cascade or daisy-chain topology.

- **Easy Access and Control**

ATEN Rack KVM Switches provide three convenient methods to access and control all the servers on your installation: Port selection pushbuttons on the switch, hotkey combinations from the keyboard, and a menu-driven OSD (On Screen Display) system.

- **Strong Security**

To prevent unwanted access to your installation, ATEN Rack KVM Switches contain authentication and authorization procedures.

- **Dual Interface – Multi-Platform Support**

ATEN Rack KVM switches support optional custom cables or converters allowing PS/2 and USB interfaces on the same installation. The custom cables support any combination of Windows, Mac, Sun, or Linux systems to coexist and be integrated into the KVM switch management system.

- **Boost Management Efficiency**

ATEN Rack KVM Switches feature a dynamic Auto Scan function that automatically switches among user selected ports at user-specified intervals – allowing administrators to monitor rack KVM switch status.

- **Video DynaSync™**

ATEN's exclusive Video DynaSync™ technology automatically detects the horizontal and vertical offset values of the remote screen and synchronizes them with the local screen. As a result, the display resolution will always be correct when switching ports.

Note:

The features highlighted above are not available in all products. Please refer to each product page for more details. Product information is subject to change without prior notice.

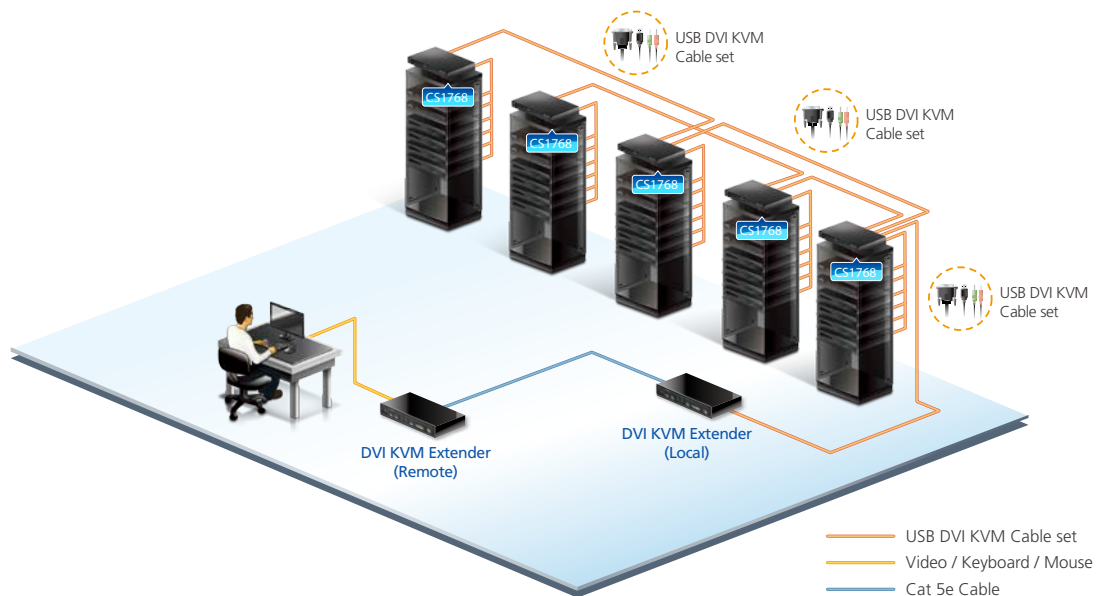

Feature Comparison

Model No.	CS1798	CS17916	CS1788	CS1768	CS1754
Console Connections	1	1	1	1	1
Ports	8	16	8	8	4
Interface	Keyboard, Mouse	USB	USB	USB	PS/2-USB
	Video	HDMI	HDMI	DVI (Dual Link), VGA	VGA
Expansion	512 (Cascade)	256 (Cascade)	512 (Cascade)	512 (Cascade)	64 (Cascade)
Platform Support	Windows, Linux, Mac, Sun	Windows, Linux, Mac, Sun	Windows, Linux, Mac, Sun	Windows, Linux, Mac, Sun	Windows, Linux, Mac, Sun
Audio	•	•	•	•	•
USB Peripheral Port	•	•	•	•	N/A
Video DynaSync™	•	•	•	•	N/A
Port Selection	OSD, Hotkey, Pushbutton	OSD, Hotkey, Pushbutton	OSD, Hotkey, Pushbutton	OSD, Hotkey, Pushbutton	OSD, Hotkey, Pushbutton

Model No.	CS1758	CS1308	CS1316	CS1708A	CS1716A
Console Connections	1	1	1	1	1
Ports	8	8	16	8	16
Interface	Keyboard, Mouse	PS/2-USB	PS/2-USB	PS/2-USB	PS/2-USB
	Video	VGA	VGA	VGA	VGA
Expansion	512 (Cascade)	64 (Cascade)	256 (Cascade)	256 (Daisy-chain)	512 (Daisy-chain)
Platform Support	Windows, Linux, Mac, Sun	Windows, Linux, Mac, Sun	Windows, Linux, Mac, Sun	Windows, Linux, Mac, Sun	Windows, Linux, Mac, Sun
Audio	•	N/A	N/A	N/A	N/A
USB Peripheral Port	N/A	N/A	N/A	•	•
Video DynaSync™	N/A	•	•	•	•
Port Selection	OSD, Hotkey, Pushbutton	OSD, Hotkey, Pushbutton	OSD, Hotkey, Pushbutton	OSD, Hotkey, Pushbutton	OSD, Hotkey, Pushbutton

Model No.	ACS1216A	CS9134	CS9138
Console Connections	1	1	1
Ports	16	4	8
Interface	Keyboard, Mouse	PS/2	PS/2
	Video	VGA	VGA
Expansion	512 (Daisy-chain)	64 (Cascade)	512 (Cascade)
Platform Support	Windows, Linux	Windows, Linux	Windows, Linux
Audio	N/A	N/A	N/A
USB Peripheral Port	N/A	N/A	N/A
Video DynaSync™	N/A	N/A	N/A
Port Selection	OSD, Hotkey	OSD, Hotkey, Pushbutton	OSD, Hotkey, Pushbutton

CS1798 / CS17916

8 / 16-Port USB HDMI/Audio KVM Switch



1

Rack KVM Switches

Front

• CS1798



• CS17916



Rear

• CS1798



• CS17916



Features

- Cascadable to three levels – control up to 512 computers (CS1798)¹; or two levels – up to 256 computers (CS17916)
- Multi-Display feature – stack up to 8 CS1798 / CS17916 units and display video from up to 8 monitors (dual display / triple display / quad display / multi-display)
- [Video DynaSync™ – exclusive ATEN technology eliminates boot-up display problems and optimizes the resolution when switching between ports](#)
- Audio enabled – full bass response provides a rich experience for 2.0 channel stereo sound
- Multilingual OSD supports English, French, German, Japanese, Russian, Simplified Chinese, Spanish and Traditional Chinese
- Independent switching of KVM and USB focus²
- Two-level (administrator / user) password authorization for enhanced security protection
- OSD Backup / Restore feature – enables the administrator to back up the switch's configuration and user profile information
- Broadcast mode – operations simultaneously performed on all selected computers, software installation and upgrading, system wide shutdown, etc.
- Console audio port on front panel for easy access
- Auto Scan Mode for monitoring all computers
- Console mouse port emulation / bypass feature supports most mouse drivers and multifunction mice
- Complete keyboard emulation for error-free booting
- Mac / Sun keyboard support and emulation³
- Multilingual keyboard mapping – supports English (US), English (UK), French, German, German (Swiss), Hungarian, Italian, Japanese, Korean, Russian, Simplified Chinese, Spanish, Swedish and Traditional Chinese
- Supports hot-plugging

Note: 1. CS1798 cascade to CS1798 only
2. Enable mouse emulation for independent switching
3. For PC compatible computers. Mac and Sun computers must be compatible with USB connections. PC keyboard combinations emulate Mac / Sun keyboards; Mac / Sun keyboards work only with their own computers

Specifications

Function	CS1798	CS17916
Computer Connections		
Direct	8	16
Maximum	512 (via Cascade)	256 (via Cascade)
Connectors		
Console Ports	1 x HDMI Female 2 x USB Type A Female 2 x 3.5 mm Audio Jack Female (Green; 1 x front panel, 1 x rear panel)	1 x HDMI Female 2 x USB Type A Female 2 x 3.5 mm Audio Jack Female (Green; 1 x front panel, 1 x rear panel)
KVM Ports	8 x HDMI Female 8 x USB Type B Female 8 x 3.5 mm Audio Jack Female (Green)	16 x HDMI Female 16 x USB Type B Female 16 x 3.5 mm Audio Jack Female (Green)
Firmware Upgrade	1 x RJ11 Female	
Power	1 x DC Jack	
USB Hub	2 x USB Type A Female (1 x front panel, 1 x rear panel)	
Port Selection	OSD, Hotkey, Pushbutton	
Emulation		
Keyboard / Mouse	USB	
Video	1920 x 1080 @ 60Hz; 1920 x 1200 @ 60Hz	
LEDs		
On Line / Selected	8 (Orange)	16 (Orange)
Power	1 (Dark Green)	
USB Link	8 (Green)	16 (Green)
Power Consumption	DC5V: 8.56W	DC5V: 8.66W
Environmental		
Operating Temperature	0 – 50°C	
Storage Temperature	-20 – 60°C	
Humidity	0 – 80% RH, Non-condensing	
Physical Properties		
Housing	Metal	
Weight	3.49 kg (7.69 lb)	3.86 kg (8.5 lb)
Dimensions (L x W x H)	43.24 x 25.72 x 4.40 cm (17.02 x 10.13 x 1.73 in.)	
Carton Lot	3 pcs	
Included Accessories	2x USB HDMI KVM Cables; 1x Mounting Kit; 1x Firmware Upgrade Cable; 1x Power Adapter	

Optional Accessories

Type	Part No. / Spec.	Page No.
USB HDMI KVM Cables	2L-7D02UH (1.8 m)	12-3 T
LockPro - HDMI Cable Lock	2X-EA12	12-4

CS1788

8-Port USB DVI Dual Link/Audio KVM Switch

Dual Link



1

Rack KVM Switches

Front



Rear



Features

- Cascadable up to three levels – control up to 512 computers
- Multi-view feature – stack up to four CS1788 units and display video from up to four monitors (dual view / triple view / quad view)
- Computer ports support digital (DVI) and analog (VGA) video inputs* – mixed operation possible
- KVM console supports a digital (DVI) or analog (VGA) video output
- Two-level (administrator / user) password authorization for enhanced security protection
- OSD backup / restore feature
- [Video DynaSync™ – exclusive ATEN technology eliminates boot-up display problems and optimizes the resolution when switching between ports](#)
- Broadcast mode – operations simultaneously performed on all selected computers, software installation and upgrading, system wide shutdown, etc.
- Console audio ports on front panel for easy access – ideal for IP phones
- HDCP compatible
- Independent switching of KVM and USB focus
- Console mouse port emulation / bypass feature supports most mouse drivers and multifunction mice
- Multilingual keyboard mapping – supports English (US), English (UK), French, German, German (Swiss), Hungarian, Italian, Japanese, Korean, Russian, Simplified Chinese, Spanish, Swedish and Traditional Chinese
- Multilingual OSD supports English, French, German, Japanese, Russian, Simplified Chinese, Spanish and Traditional Chinese
- Rack-mountable in 19" system rack
- Supports keyboard combinations via emulation (for Sun / Mac)

Note:* A VGA input requires a VGA to DVI adapter or a VGA to DVI KVM cable (2L-7DX2U / 2L-7DX3U)

Specifications

Function	CS1788
Computer Connectins	
Direct	8
Maximum	512 (via Cascade)
Connectors	
Console Ports	1 x HDB-15 Female (Blue) 1 x DVI-I Female (white) 2 x USB Type A Female 2 x 3.5 mm Audio Jack Female (Green; 1 x front panel, 1 x rear panel) 2 x 3.5 mm Audio Jack Female (Pink; 1 x front panel; 1 x rear panel)
KVM Ports	8 x DVI-I Female (White) 8 x USB Type B Female 8 x 3.5 mm Audio Jack Female (Green) 8 x 3.5 mm Audio Jack Female (Pink)
Firmware Upgrade	1 x RJ-11 Female
Power	1 x DC Jack
USB Hub	2 x USB Type A Female (1 x front panel, 1 x rear panel)
Port Selection	OSD, Hotkey, Pushbutton
Emulation	
Keyboard / Mouse	USB
Video	DVI (Dual Link): 2560 x 1600 @ 60Hz; VGA: 2048 x 1536 @ 60Hz
LEDs	
USB Link	8 (Green)
Power	1 (Dark Green)
On Line / Selected	8 (Orange)
Power Consumption	DC5.3V: 8.26W
Environmental	
Operating Temperature	0 – 50°C
Storage Temperature	-20 – 60°C
Humidity	0 – 80% RH, Non-condensing
Physical Properties	
Housing	Metal
Weight	2.80 kg (6.17 lb)
Dimensions (L x W x H)	43.72 x 16.12 x 4.40 cm (17.21 x 6.35 x 1.73 in.)
Carton Lot	3 pcs
Included Accessories	2x USB DVI-D Dual Link KVM Cables; 1x Firmware Upgrade Cable; 1x Mounting Kit; 1x Power Adapter

Optional Accessories

Type	Part No. / Spec.	Page No.
USB DVI-D Single Link KVM Cables	2L-7D02U (1.8 m), 2L-7D03U (3 m), 2L-7D05U (5 m)	12-3 O
USB DVI-I Single Link KVM Cables	2L-7D02UI (1.8 m), 2L-7D03UI (3 m)	12-3 O
USB DVI-D Dual Link KVM Cables	2L-7D02UD (1.8 m), 2L-7D03UD (3 m), 2L-7D05UD (5 m)	12-3 P
USB VGA to DVI-A KVM Cable	2L-7DX2U (1.8 m), 2L-7DX3U (3 m)	12-3 R
USB HDMI to DVI-D KVM Cable	2L-7D02DH (1.8 m)	12-3 S

CS1768

8-Port USB DVI/Audio KVM Switch



1

Rack KVM Switches

Front



Rear



Features

- Cascadable up to three levels – control up to 512 computers
- Multiview mode – stack up to four CS1768 units and display video from up to four monitors (dual view / triple view / quad view)
- Computer ports support digital (DVI) or analog (VGA) video inputs*
- KVM console supports a digital (DVI) or analog (VGA) video output
- OSD backup / restore feature
- Two-level (administrator / user) password authorization for enhanced security protection
- [Video DynaSync™ – exclusive ATEN technology eliminates boot-up display problems and optimizes the resolution when switching between ports](#)
- Broadcast mode – operations simultaneously performed on all selected computers, software installation and upgrading, system wide shutdown, etc.
- Console audio ports on front panel for easy access – ideal for IP phones
- HDCP compatible
- Independent switching of KVM and USB focus
- Console mouse port emulation / bypass feature supports most mouse drivers and multifunction mice
- Multilingual OSD supports English, French, German, Japanese, Russian, Simplified Chinese, Spanish and Traditional Chinese
- Multilingual keyboard mapping – supports English (US), English (UK), French, German, German (Swiss), Hungarian, Italian, Japanese, Korean, Russian, Simplified Chinese, Spanish, Swedish and Traditional Chinese
- Rack-mountable in 19" system rack
- Supports keyboard combinations via emulation (for Sun / Mac)

Note:* A VGA input requires a VGA to DVI adapter or a VGA to DVI KVM cable (2L-7DX2U / 2L-7DX3U)

Specifications

Function	CS1768
Computer Connections	
Direct	8
Maximum	512 (via Cascade)
Connectors	
Console Ports	1 x HDB-15 Female (Blue) 1 x DVI-I Female (White) 2 x USB Type A Female 2 x 3.5 mm Audio Jack Female (Pink; 1 x front panel, 1 x rear panel) 2 x 3.5 mm Audio Jack Female (Green; 1 x front panel, 1 x rear panel)
KVM Ports	8 x DVI-I Female (White) 8 x USB Type B Female 8 x 3.5 mm Audio Jack Female (Green) 8 x 3.5 mm Audio Jack Female (Pink)
Firmware Upgrade	1 x RJ-11 Female (Black)
Power	1 x DC Jack
USB Hub	2 x USB Type A Female (1 x front panel, 1 x rear panel)
Port Selection	OSD, Hotkey, Pushbutton
Emulation	
Keyboard / Mouse	USB
Video	DVI (Single Link): 1920 x 1200 @ 60Hz; VGA: 2048 x 1536 @ 60Hz
LEDs	
USB Link	8 (Green)
Power	1 (Dark Green)
On Line / Selected	8 (Orange)
Power Consumption	DC5.3V: 4.53W
Environmental	
Operating Temperature	0-50°C
Storage Temperature	-20-60°C
Humidity	0 - 80% RH, Non-condensing
Physical Properties	
Housing	Metal
Weight	2.80 kg (6.17 lb)
Dimensions (L x W x H)	43.72 x 16.12 x 4.40 cm (17.21 x 6.35 x 1.73 in.)
Carton Lot	3 pcs
Included Accessories	2x USB DVI-D Single Link KVM Cables; 1x Firmware Upgrade Cable; 1x Mounting Kit; 1x Power Adapter

Optional Accessories

Type	Part No. / Spec.	Page No.
USB DVI-D Single Link KVM Cables	2L-7D02U (1.8 m), 2L-7D03U (3 m), 2L-7D05U (5 m)	12-3 O
USB DVI-I Single Link KVM Cable	2L-7D02UI (1.8 m), 2L-7D03UI (3 m)	12-3 O
USB VGA to DVI-A KVM Cable	2L-7DX2U (1.8 m), 2L-7DX3U (3 m)	12-3 R
USB HDMI to DVI-D KVM Cable	2L-7D02DH (1.8 m)	12-3 S

CS1754 / CS1758

4 / 8-Port PS/2-USB VGA/Audio KVM Switch

Rack-Mountable PS/2 & USB Switch + Audio



Front

- CS1754



- CS1758



Rear

- CS1754



- CS1758



Features

- Cascadable up to 3 levels – control up to 64 / 512 computers
- Dual interface supports computers with PS/2 or USB keyboards and mice
- Auto PS/2 and USB interface detection
- **Buzzer on/off via hotkey and OSD**
- ATEN USB ASIC inside
- Special design for easy stacking
- Rack-mountable in 19" system rack

Specifications

Function	CS1754	CS1758
Computer Connections		
Direct	4	8
Maximum	64 (via Cascade)	512 (via Cascade)
Connectors		
Console Ports	1 x HDB-15 Female (Blue) 2 x USB Type A Female 1 x 3.5 mm Audio Jack Female (Green) 1 x 3.5 mm Audio Jack Female (Pink)	
KVM Ports	4 x SPHD-15 Female (Yellow) 4 x 3.5 mm Audio Jack Female (Green) 4 x 3.5 mm Audio Jack Female (Pink)	8 x SPHD-15 Female (Yellow) 8 x 3.5 mm Audio Jack Female (Green) 8 x 3.5 mm Audio Jack Female (Pink)
Firmware Upgrade	1 x RJ-11 Female	
Power	1 x DC Jack (Black)	
Port Selection	OSD, Hotkey, Pushbutton	
Emulation		
Keyboard / Mouse	USB	
Video	2048 x 1536; DDC2B	
LEDs		
Online	4 (Orange)	8 (Orange)
Selected	4 (Green)	8 (Green)
Power	1 (Blue)	1 (Blue)
Power Consumption	DC5V: 1.63W	DC5V: 2.32W
Environmental		
Operating Temperature	0-50°C	
Storage Temperature	-20-60°C	
Humidity	0-80% RH, Non-condensing	
Physical Properties		
Housing	Metal	
Weight	2.64 kg (5.81 lb)	2.72 kg (5.99 lb)
Dimensions (L x W x H)	43.72 x 16.10 x 4.40 cm (17.21 x 6.34 x 1.73 in.)	
Carton Lot	3 pcs	
Included Accessories	1x Firmware Upgrade Cable; 1x Mounting Kit; 1x Power Adapter	

Optional Accessories

Type	Part No. / Spec.	Page No.
PS/2 KVM Cables	2L-5302P (1.8 m), 2L-5303P (3 m), 2L-5305P (5 m)	12-2 M
USB KVM Cables	2L-5301U (1.2 m), 2L-5302U (1.8 m), 2L-5303U (3 m), 2L-5305U (5 m)	12-2 L

CS1308 / CS1316

8 / 16-Port PS/2-USB VGA KVM Switch



Front

- CS1308



- CS1316



Rear

- CS1308



- CS1316



Features

- Cascadable up to 2 levels – control up to 64 / 256 computers
- [Video DynaSync™ – exclusive ATEN technology eliminates boot-up display problems and optimizes the resolution when switching between ports](#)
- Broadcast mode – operations simultaneously performed on all selected computers, software installation and upgrading, system wide shutdown, etc.
- Dual interface – supports computers with PS/2 or USB keyboards and mice
- Auto PS/2 and USB interface detection
- [Buzzer on/off via hotkey and OSD](#)
- Rack-mountable in 19" system rack

Specifications

Function	CS1308	CS1316
Computer Connections		
Direct	8	16
Maximum	64 (via Cascade)	256 (via Cascade)
Port Selection	OSD, Hotkey, Pushbutton	
Connectors		
Console Ports	1 x SPHD-18 Male (Yellow)	
KVM Ports	8 x SPHD-15 Female (Yellow)	16 x SPHD-15 Female (Yellow)
Firmware Upgrade	1 x RJ-11 Female (Black)	
Power	1 x DC Jack	
Emulation		
Keyboard / Mouse	PS/2, USB	
Video	2048 x 1536; DDC2B	
LEDs		
Online	8 (Orange)	16 (Orange)
Selected	8 (Green)	16 (Green)
Power	1 (Dark Green)	
Power Consumption	DC5.3V: 2.34W	DC5.3V: 3.83W
Environmental		
Operating Temperature	0 – 50°C	
Storage Temperature	-20 – 60°C	
Humidity	0 – 80% RH, Non-condensing	
Physical Properties		
Housing	Metal	
Weight	1.89 kg (4.16 lb)	2.10 kg (4.63 lb)
Dimensions (L x W x H)	43.72 x 16.13 x 4.40 cm (17.21 x 6.35 x 1.73 in.)	
Carton Lot	3 pcs	
Included Accessories	1x Console Cable; 1x Firmware Upgrade Cable; 1x Mounting Kit; 1x Power Adapter	

Optional Accessories

Type	Part No. / Spec.	Page No.
PS/2 KVM Cables	2L-5201P (1.2 m), 2L-5202P / 2L-5702P (1.8 m), 2L-5203P (3 m), 2L-5206P (6 m)	12-1 C 12-1 D
USB KVM Cables	2L-5201U (1.2 m), 2L-5202U (1.8 m), 2L-5203U (3 m), 2L-5205U (5 m)	12-2 N

CS1708A / CS1716A

8 / 16-Port PS/2-USB VGA KVM Switch with Daisy-Chain Port and USB Peripheral Support

Rack-Mountable PS/2 & USB KVM Switch with USB Peripheral Port



Front

- CS1708A



- CS1716A



Rear

- CS1708A



- CS1716A



Features

- Daisy-chain up to 31 additional units – control up to 256 / 512 computers from a single console
- [Video DynaSync™ – exclusive ATEN technology eliminates boot-up display problems and optimizes the resolution when switching between ports](#)
- Auto-senses station's position on daisy-chained installations; no need for manual DIP switch setting; front panel LED indicates station's position
- Broadcast mode – operations simultaneously performed on all selected computers, software installation and upgrading, system wide shutdown, etc.
- Auto PS/2 and USB interface detection
- [Buzzer on/off via hotkey and OSD](#)

Specifications

Function	CS1708A	CS1716A
Computer Connections		
Direct	8	16
Maximum	256 (via Daisy-chain)	512 (via Daisy-chain)
Port Selection	OSD, Hotkey, Pushbutton	
Connectors		
Console Ports	1 x SPHD-18 Male (Yellow)	
KVM Ports	8 x SPHD-15/17 Female (Yellow)	16 x SPHD-15/17 Female (Yellow)
Daisy Chain Ports	1 x DB-25 Female (Black) 1 x DB-25 Male (Black)	
Firmware Upgrade	1 x RJ-11 Female	
Power	1 x DC Jack Female	
USB Port	1 x USB Type A Female	
Emulation		
Keyboard / Mouse	PS/2, USB	
Video	2048 x 1536; DDC2B	
LEDs		
Online	8 (Orange)	16 (Orange)
Selected	8 (Green)	16 (Green)
Station ID	1 x 2-digit, 7-segment (Orange)	
Power	1 (Dark Green)	
Power Consumption	DC5.3V: 3.8W	DC5.3V: 5.31W
Environmental		
Operating Temperature	0 – 50°C	
Storage Temperature	-20 – 60°C	
Humidity	0 – 80% RH, Non-condensing	
Physical Properties		
Housing	Metal	
Weight	2.66 kg (5.86 lb)	2.85 kg (6.28 lb)
Dimensions (L x W x H)	43.72 x 15.99 x 4.40 cm (17.21 x 6.3 x 1.73 in.)	
Carton Lot	3 pcs	
Included Accessories	1x USB KVM Cable; 1x PS/2 KVM Cable; 1x Console Cable; 1x Firmware Upgrade Cable; 1x Mounting Kit; 1x Power Adapter	

Optional Accessories

Type	Part No. / Spec.	Page No.
PS/2 KVM Cables	2L-5201P (1.2 m), 2L-5202P / 2L-5702P (1.8 m), 2L-5203P (3 m), 2L-5206P (6 m)	12-1 C 12-1 D
USB KVM Cables	2L-5201U (1.2 m), 2L-5202U (1.8 m), 2L-5203U (3 m), 2L-5205U (5 m)	12-2 N
Daisy-chain Cables	2L-1700 (0.6 m), 2L-1701 (1.8 m), 2L-1703 (3 m), 2L-1705 (5 m), 2L-1715 (15 m)	12-3 V

ACS1216A

16-Port PS/2 VGA KVM Switch with Daisy-Chain Port



Front



Rear



Features

- Daisy-chain up to 31 additional units – control up to 512 computers from a single console
- Broadcast mode – operations simultaneously performed on all selected computers, software installation and upgrading, system wide shutdown, etc.
- Firmware upgrades to all chained KVM switches simultaneously via daisy-chain cable
- Auto-senses station's position on daisy-chained installations; no need for manual DIP switch setting; front panel LED indicates station's position
- Rack-mountable in 19" system rack

Specifications

Function	ACS1216A
Computer Connections	
Direct	16
Maximum	512 (via Daisy-chain)
Port Selection	
OSD, Hotkey	
Connectors	
Console Ports	1 x HDB-15 Female (Blue) 1 x 6-pin Mini-DIN Female (Purple) 1 x 6-pin Mini-DIN Female (Green)
KVM Ports	16 x SPHD-15 Female (Yellow)
Daisy Chain Ports	1 x DB-25 Female (Black) 1 x DB-25 Male (Black)
Firmware Upgrade	1 x RJ-11 Female
Power	1 x DC Jack (Black)
Emulation	
Keyboard / Mouse	PS/2
Video Resolution	
2048 x 1536; DDC2B	
LEDs	
Online	16 (Orange)
Selected	16 (Green)
Station ID	2 x 7-segment (Orange)
Power	1 (Blue)
Power Consumption	
DC9V: 6.27W	
Environmental	
Operating Temperature	0 - 50°C
Storage Temperature	-20 - 60°C
Humidity	0-80% RH, Non-condensing
Physical Properties	
Housing	Metal
Weight	2.96 kg (6.53 lb)
Dimensions (L x W x H)	43.72 x 15.92 x 4.40 cm (17.21 x 6.27 x 1.73 in.)
Carton Lot	
3 pcs	
Included Accessories	
1x PS/2 KVM Cable; 1x Firmware Upgrade Cable; 1x Mounting Kit; 1x Power Adapter	

Optional Accessories

Type	Part No. / Spec.	Page No.
PS/2 KVM Cables	2L-5201P (1.2 m), 2L-5202P / 2L-5702P (1.8 m), 2L-5203P (3 m), 2L-5206P (6 m)	12-1 C 12-1 D
Daisy-chain Cables	2L-1700 (0.6 m), 2L-1701 (1.8 m), 2L-1703 (3 m), 2L-1705 (5 m), 2L-1715 (15 m)	12-3 V
Cables & Converters for USB Interface Support	2L-5202UP (1.8 m), 2L-5203UP (3 m), 2L-5205UP (5 m), 2L-5206UP (6 m) Supports Mac Keyboards Emulation: UC100KMA	12-1 E 9-3

CS9134 / CS9138

4 / 8-Port PS/2 VGA KVM Switch



Front

- CS9134



- CS9138



Rear

- CS9134

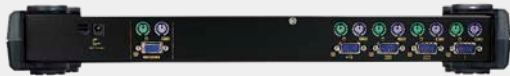

- CS9138



Features

- Cascadable up to 3 levels – control up to 64 / 512 computers
- PS/2 Keyboard and mouse emulation for error-free booting
- Supports Microsoft IntelliMouse, Logitech MouseMan, FirstMouse, IBM Scrollpoint Mouse
- OSD automatically adjusts to resolution changes
- Auto Scan function to monitor computer operation
- Special design for easy stacking
- Rack-mountable in 19" system rack

Specifications

Function	CS9134	CS9138
Computer Connections		
Direct	4	8
Maximum	64 (via Cascade)	512 (via Cascade)
Connectors		
Console Ports	1 x HDB-15 Female (Blue) 1 x 6-pin Mini-DIN Female (Purple) 1 x 6-pin Mini-DIN Female (Green)	
KVM Ports	4 x HDB-15 Male (Blue) 4 x 6-pin Mini-DIN Female (Purple) 4 x 6-pin Mini-DIN Female (Green)	8 x HDB-15 Male (Blue) 8 x 6-pin Mini-DIN Female (Purple) 8 x 6-pin Mini-DIN Female (Green)
Power	1 x DC Jack	
Port Selection	OSD, Hotkey, Pushbutton	
Emulation		
Keyboard / Mouse	PS/2	
Video	1920 x 1440; DDC2B	
LEDs		
Online	4 (Green)	8 (Green)
Selected	4 (Orange)	8 (Orange)
Power	1 (Blue)	
Power Consumption	DC9V: 0.9W	DC9V: 1.5W
Environmental		
Operating Temperature	0 - 50°C	
Storage Temperature	-20 - 60°C	
Humidity	0-80% RH, Non-condensing	
Physical Properties		
Housing	Metal	
Weight	2.55 kg (5.62 lb)	2.85 kg (6.28 lb)
Dimensions (L x W x H)	43.72 x 16.29 x 4.40 cm (17.21 x 6.41 x 1.73 in.)	
Carton Lot	3 pcs	
Included Accessories	1x Mounting Kit; 1x Power Adapter	

Optional Accessories

Type	Part No. / Spec.	Page No.
PS/2 KVM Cables	2L-1001P/C (1.8 m), 2L-1003P/C (3 m), 2L-1005P/C (5 m), 2L-1006P/C (6 m), 2L-1010P/C (10 m), 2L-1020P/C (20 m), 2L-5001P/C (1.2 m), 2L-5002P/C (1.8 m), 2L-5003P/C (3 m), 2L-5005P/C (5 m), 2L-1040P (40 m), 2L-1030P (30 m)	12-1 A
Cables & Converters for USB Interface Support	2L-5502UP (1.8 m), 2L-5503UP (3 m), 2L-5506UP (6 m) Supports Mac Keyboards Emulation: UC100KMA	12-1 B 9-3



KVM over IP Switches

2

KVM over IP Switches

CN8000A – Provides over IP Capability for KVM Switches

The CN8000A is our most cost-effective over IP solution and is perfect for small racks in data centers without built-in IP functionality.

CS1708I / CS1716I – All-in-One over IP Server Management Solution

The CS1708I / CS1716I KVM switches are IP-based KVM control units that allow both local and remote users to monitor and access multiple computers from a single console.



- **Remote Desktop Scaling**

KVM over IP switches allow administrators to view the installation server's video output from remote locations in either full-screen or in a flexible scaled window.

- **Unrestricted Language Input**

The KVM over IP switches support an on-screen keyboard available in multiple languages.

- **Powerful Security Alternatives**

KVM over IP switches support authentication and authorization management from third-party authentication services – e.g. RADIUS, LDAP, LDAPS, and MS Active Directory.

- **Serial Console Management**

CN8000A KVM over IP switch provides serial console management such as serial terminal access and out-of-band support. Serial terminal access can be accomplished either with the switch's built-in serial viewer, or via third-party software (such as PuTTY) for Telnet and SSH sessions.

- **Centralized Server Monitoring**

The switch's Panel Array Mode™ allows administrators to display the video output of up to 16 servers on their monitors simultaneously, while a convenient Auto Scan feature permits automatic switching from port to port at user-specified intervals.

- **Mouse DynaSync™**

The Mouse DynaSync™ function provides automatic locked-in synchronizing for the remote and local mouse pointers – resulting in perfect mouse alignment regardless of the mouse acceleration settings on the server and eliminating the need for synchronizing time between the two mice.

- **Centralized Real-Time Updating and Maintenance**

Virtual Media support allows users to map DVD / CD-ROMs and other storage media to a remote server. Performing firmware upgrades, diagnostic tests, file transfers, and installing OS and application patches can all be accomplished smoothly and quickly across the installation from a single console located anywhere in the world.

- **Message Board**

The Message Board function is similar to an Internet chat room and it allows administrators to share management information and resolve port access conflicts.

Note:

The features highlighted above are not available in all products. Please refer to each product page for more details. Product information is subject to change without prior notice.

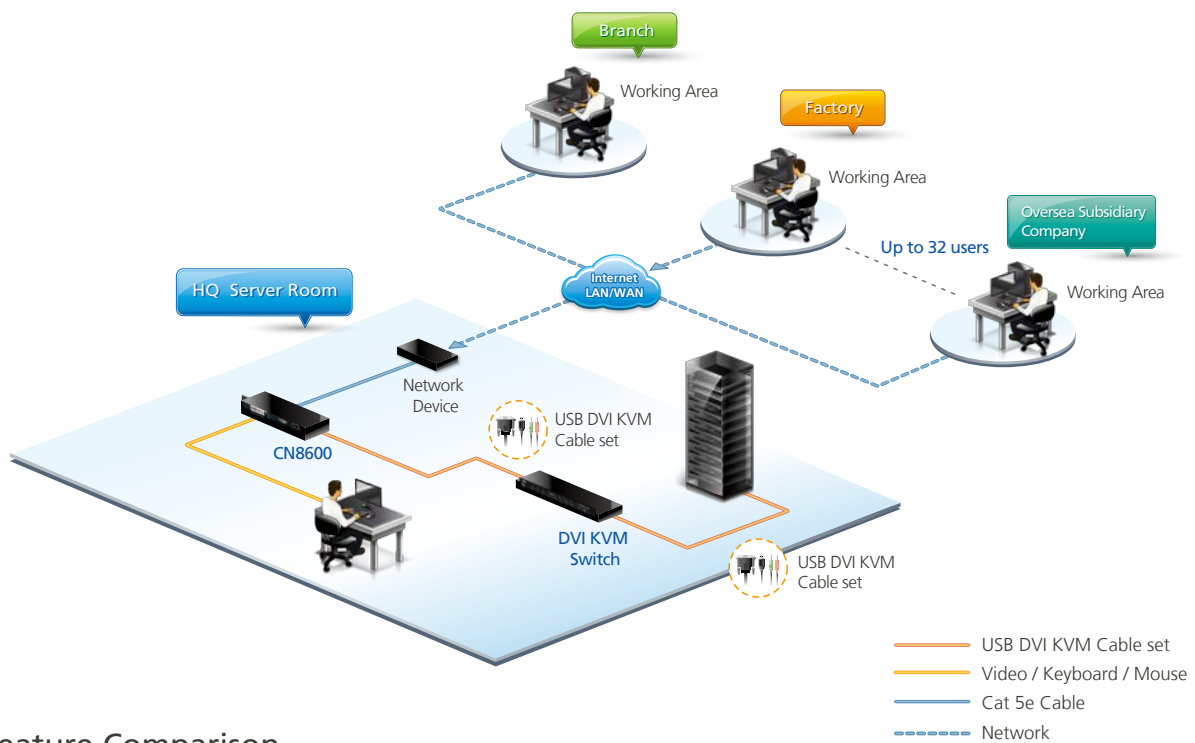

Feature Comparison

Model No.		CN8000A	CN8600	CS1708I / CS1716I
Type		KVM over IP	KVM over IP	KVM over IP
Computer Connections	Direct	1	1	8 / 16
	Max.	1	1	128 / 256
Interface	Video	VGA	DVI-D	VGA
Bus Sessions	Local/Remote	1	1	1
Local Console		PS/2, USB	USB	PS/2, USB
Mouse DynaSync™		•	•	•
Virtual Media		•	•	N/A
Panel Array Mode		N/A	N/A	•
Smart Card Reader		•	•	N/A
IPv6		•	•	•

CN8000A

1-Local/Remote Share Access Single Port VGA KVM over IP Switch (1920 x 1200)



Front



Rear



Features

- High video resolution – up to 1920 x 1200 @ 60 Hz*
- Laptop USB Console (LUC) – A dedicated USB port directly connects to laptop for easy console operation*
- Easy configuration through local console OSD*
- Message board – convenient communication for remote users
- Serial console management – access server via built-in serial viewer or third party software (such as PuTTY) for Telnet and SSH sessions
- Exit macro support
- Integration with ATEN CC2000 Centralized Management Software
- Provides over IP capability to KVM switches without over IP functionality
- Critical system events sent by email and SNMP trap; Syslog support
- Local console, browser-based and AP GUIs offer a unified multilingual interface for easy and convenient use
- Browser-based UI in pure web technology allows administrators to perform administrative tasks without a pre-installed Java software package required
- Supports TLS 1.2 data encryption and RSA 2048-bit certificates for secure users logging in from browsers

Specifications

Function	CN8000A
Computer Connections	
Direct / Max.	1
Console Connections	
Local / Remote	1
Connectors	
Console Ports	1 x SPHD-18 Male (Yellow)
KVM (Computer) Ports	1 x SPHD-18 Female (Yellow)
Laptop USB Console (LUC) Port	1 x USB Mini-B Female
PON	1 x DB-9 Male
Modem / RS-232	1 x DB-9 Male
LAN Ports	1 x RJ-45 Female
Power	1 x DC Jack
LEDs	
Power	1 (Orange)
Link	1 (Green)
10/100/1000 Mbps	1 (Orange / Orange + Green / Green)
Video	Up to 1920 x 1200 @ 60Hz; DDC2B
Emulation	
Keyboard / Mouse	USB; PS/2
Power Consumption	DC 5.3V, 7.26W
Environmental	
Operating Temperature	0 - 50°C (CN8000A) 0 - 40°C (Power Adapter)
Storage Temperature	-20 - 60°C
Humidity	0 - 80% RH, Non-condensing
Physical Properties	
Housing	Metal
Weight	0.49 kg (1.08 lb)
Dimensions (L x W x H)	20.00 x 8.14 x 2.50 cm (7.87 x 3.2 x 0.98 in.)
Carton Lot	5 pcs
Included Accessories	1x Custom KVM Cable; 1x Custom Console Cable; 1x Laptop USB Console Cable; 1x Power Adapter; 1x Mounting Kit

Optional Accessories

Type	Part No. / Spec.	Page No.
USB KVM Cables	2L-5201U (1.2 m), 2L-5202U (1.8 m), 2L-5203U (3 m), 2L-5205U (5 m)	12-2 N
PS/2 KVM Cables	2L-5201P (1.2 m), 2L-5202P / 2L-5702P (1.8 m), 2L-5203P (3 m), 2L-5206P (6 m)	12-1 C 12-1 D
PS/2-USB KVM Cables	2L-5301UP (1.2 m), 2L-5302UP (1.8 m), 2L-5303UP (3 m)	12-2 G

CN8600

1-Local/Remote Share Access Single Port DVI KVM over IP Switch (1920 x 1200)



Front



Rear



Features

- A mini USB port in the rear panel can serve as a Virtual Media USB port or a Laptop USB Console (LUC) port
- Message board – convenient communication for remote users
- Two 10/100/1000 Mbps NICs for redundant LAN or two IP operation
- Dual power supply for power backup
- Enhanced FPS (Frames Per Second) throughput for vivid video quality
- Local/Remote Share Mode conveniently grants shared, occupied or exclusive console privilege
- Console Lock Switch – flexible remote/console access management
- Integration with ATEN CC2000 Centralized Management Software
- Provides over IP capability to DVI KVM switches without over IP functionality*
- Audio support – microphone and speaker ports on the local and remote console
- Access the CN8600 via a built-in serial viewer, or via third-party software (such as PuTTY) for Telnet and SSH sessions
- Supports TLS 1.2 data encryption and RSA 2048-bit certificates for secure users logging in from browsers

Note: * Compatible KVM Switch: ATEN DVI Single Link KVM Switches

Specifications

Function	CN8600
Computer Connections	
Direct / Max.	1
Console Connections	
Local / Remote	1
Connectors	
Console Ports	2 x USB Type A Female (White) 1 x DVI-D Female (White) 1 x Mini Stereo Jack Female (Green) 1 x Mini Stereo Jack Female (Pink)
KVM Ports	1 x USB Type B Female (White) 1 x DVI-D Female (White) 1 x Mini Stereo Jack Female (Green) 1 x Mini Stereo Jack Female (Pink)
LAN Ports	2 x RJ-45 Female
Virtual Media	1 x USB Mini-B Female
Power	2 x DC Jack
PON	1 x RJ-45 Female
Serial	1 x RJ-45 Female
Control	1x PS/2 port
LEDs	
Console Status	1 (Green)
10/100/1000 Mbps	2 (Orange / Orange+Green / Green)
Remote Login	1 (Green)
Power	1 (Green)
Video	Local / Remote - 1920 x 1200 @ 60Hz
Emulation	
Keyboard / Mouse	USB
Power Consumption	DC 5.3V, 5.56W
Environmental	
Operating Temperature	0 – 50°C
Storage Temperature	-20 – 60°C
Humidity	0 – 80% RH, Non-condensing
Physical Properties	
Housing	Metal
Weight	0.88 kg (1.94 lb)
Dimensions (L x W x H)	26.00 x 7.64 x 4.20 cm (10.24 x 3.01 x 1.65 in.)
Carton Lot	5 pcs
Included Accessories	1x USB DVI-D KVM Cable; 1x USB 2.0 Virtual Media Cable; 1x Power Adapter; 1x Mounting Kit

Optional Accessories

Type	Part No. / Spec.	Page No.
USB DVI-D Single Link KVM Cables	2L-7D02U (1.8 m), 2L-7D03U (3 m), 2L-7D05U (5 m)	12-3 O
USB DVI-I Single Link KVM Cables	2L-7D02UI (1.8 m), 2L-7D03UI (3 m)	12-3 O
USB HDMI to DVI-D Single Link KVM Cable	2L-7D02DH (1.8 m)	12-3 S

CS1708I / CS1716I

1-Local / Remote Share Access

8 / 16-Port PS/2-USB VGA KVM over IP Switch



Front

• CS1708I

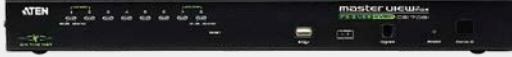

• CS1716I



Rear

• CS1708I



• CS1716I



Features

- Secure keyboard / mouse / video transmission via RC4 128-bit encryption
- Supports TLS 1.2 data encryption and RSA 2048 bit certificates for secure user logins from a browser
- **Panel array mode enables user to monitor multiple servers from single screen at the same time**
- IPv6 capable
- **Message board – convenient communication for remote users**
- Adjustable video quality for flexible adaptation to diverse network environments
- Windows client and Java client software support; Java client works with all operating systems
- Front access USB port* allows each computer to access USB peripherals
- **Video DynaSync™ – exclusive ATEN technology eliminates boot-up display problems and optimizes the resolution when switching between ports**

Note: * Local console only

Specifications

Function	CS1708I	CS1716I
Computer Connection		
Direct	8	16
Max.	128 (via daisy chain)	256 (via daisy chain)
Console Connections		
Local / Remote	1	
Port Selection	OSD / GUI; Hotkey; Pushbutton	
Connectors		
Console Ports	1 x SPHD-18 Male (Yellow)	
KVM Ports	8 x SPHD-17 Female (Yellow)	16 x SPHD-17 Female (Yellow)
Daisy Chain Ports	1 x DB-25 Male	
Power	1 x DC Jack	
LAN Ports	1 x RJ-45 Female	
Firmware Upgrade	1 x RJ-11	
USB Port	1 x USB Type A Female	
LEDs		
Online	8 (Orange)	16 (Orange)
Selected	8 (Green)	16 (Green)
Station ID	1 x 2-digit, 7-segment (Orange)	
Power	1 (Dark Green)	
10/100 Mbps	1 (Orange / Green - at LAN port)	
Emulation		
Keyboard / Mouse	PS/2, USB	
Video		
Local	2048 x 1536; DDC2B	
Remote	1920 x 1200 @ 60Hz	
Power Consumption	DC 5.3V, 7.67W	DC 5.3V, 9.2W
Environmental		
Operating Temperature	0 – 50°C	
Storage Temperature	-20 – 60°C	
Humidity	0 – 80% RH, Non-condensing	
Physical Properties		
Housing	Metal	
Weight	2.81 kg (6.19 lb)	3.00 kg (6.61 lb)
Dimensions (L x W x H)	43.72 x 15.96 x 4.40 cm (17.21 x 6.28 x 1.73 in.)	
Carton Lot	3 pcs	
Included Accessories	1x USB KVM Cable; 1x PS/2 KVM Cable; 1x Custom Console Cable; 1x Firmware Upgrade Cable; 1x Power Adapter; 1x Mounting Kit	

Optional Accessories

Type	Part No. / Spec.	Page No.
USB KVM Cables	2L-5201U (1.2 m), 2L-5202U (1.8 m), 2L-5203U (3 m), 2L-5205U (5 m)	12-2 N
PS/2 KVM Cables	2L-5201P (1.2 m), 2L-5202P / 2L-5702P (1.8 m), 2L-5203P (3 m), 2L-5206P (6 m)	12-1 C 12-1 D
Daisy-chain Cables	2L-1700 (0.6 m), 2L-1701 (1.8 m), 2L-1703 (3 m), 2L-1705 (5 m), 2L-1715 (15 m)	12-3 V



Secure KVM Switches

3

Secure KVM Switches

ATEN's full range of PSS PP v3.0 Secure KVM Switches are certified by the National Information Assurance Partnership (NIAP) to ensure high-level desktop security, protection, and data safekeeping for organizations in industries such as government and military agencies, finance, and other environments that use multiple computers of different security classifications.

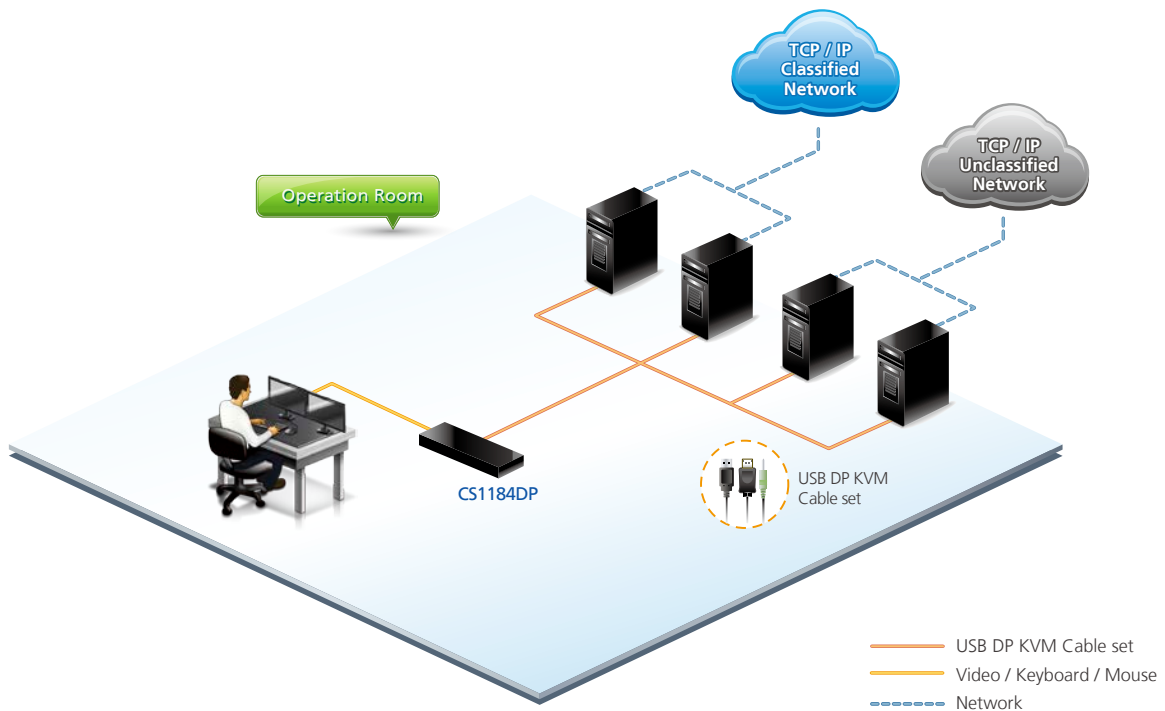

PSS PP v3.0 Secure KVM Switch Series



2 / 4 / 8-Port USB DVI / HDMI / DisplayPort
Single / Dual Display Secure KVM Switch Series



Front

- CS1182DP



- CS1184H



- CS1148D



Rear

- CS1182DP



- CS1184H



- CS1148D



NIAP Common Criteria Compliant

- Compliant with PSS PP v3.0 (Protection Profile for Peripheral Sharing Switch, Version 3.0) security requirements

Multi-Layered Security

- Always-on chassis intrusion detection – renders the ATEN PSS PP v3.0 Secure KVM Switch Series inoperable when physical tampering is detected
- Tamper-evident labels – provides visual indication of any attempt to access the ATEN PSS PP v3.0 Secure KVM Switch's internal components
- Non-reprogrammable firmware – prevents reprogramming the ATEN PSS PP v3.0 Secure KVM Switch's firmware
- Restricted peripheral connectivity – non-authorized HID's (Human Interface Devices), video, or authentication device connections are rejected

Data Channel Isolation and Unidirectional Data Flow

- True data path isolation – data cannot be transferred between computers
- The ATEN PSS PP v3.0 Secure KVM Switch controls and isolates data flow between the console devices and connected computers
- Unidirectional data flow between the console devices and the selected computer is ensured

User Data Protection

- The ATEN PSS PP v3.0 Secure KVM Switch's keyboard/mouse data is automatically deleted after transmission and automatically purged when the KVM port focus is switched

Security Management

- Supports administrative configuration of CAC Port filtering to accept or reject specific USB authentication devices
- Provides administrative functions for authorized administrator to audit KVM log data

Features

- Superior video quality – up to 4K (3840 x 2160 @ 30Hz)¹
- Port selection via pushbuttons only to enhance security
- [Video DynaSync™ – Exclusive ATEN technology eliminates boot-up display problems and optimizes resolutions when switching between ports](#)
- Supports enable/disable CAC function port by port
- LED indicators for peripheral filtering and KVM security status
- Rugged metal enclosure
- Built-in internal power
- Supports analog audio (speaker only)²

Note: 1. HDMI and DisplayPort Secure KVM Switch series supports console video output resolutions up to 4K @ 30 Hz. DVI Secure KVM Switches offer up to 3840 x 2160 @ 30 Hz video output on compatible HDMI-interfaced monitors / computers with ATEN DVI-to-HDMI KVM cables.

2. Only analog speaker data input is supported.

Specifications

Function	CS1182DP	CS1184DP	CS1188DP	CS1142DP	CS1144DP	CS1148DP
Ports	2	4	8	2	4	8
PC Video Connector	DisplayPort					
Console Video Connector	HDMI					
Number of Displays	Single display			Dual display		
Video	Max. 3840 x 2160 @ 30Hz (UHD)			Max. 3840 x 2160 @ 30Hz (UHD)		
Console Keyboard / Mouse Interface	PS2/USB			PS2/USB		
CAC Port	Yes			Yes		
Audio	analog speaker only			analog speaker only		
Keyboard / Mouse Emulation	USB			USB		
I/P Rating	100–240V~ ; 50-60Hz; 1A			100–240V~ ; 50-60Hz; 1A		
Physical Properties						
Housing	Metal			Metal		
Weight	1.76 kg (3.88 lb)	1.81 kg (3.99 lb)	3.30 kg (7.27 lb)	2.13 kg (4.69 lb)	2.18 kg (4.8 lb)	3.22 kg (7.09 lb)
Dimensions (L x W x H)	33.50 x 16.43 x 4.40 cm (13.19 x 6.47 x 1.73 in.)	33.50 x 16.43 x 4.40 cm (13.19 x 6.47 x 1.73 in.)	43.24 x 20.49 x 6.55 cm (17.02 x 8.07 x 2.58 in.)	33.50 x 16.39 x 6.55 cm (13.19 x 6.45 x 2.58 in.)	33.50 x 16.39 x 6.55 cm (13.19 x 6.45 x 2.58 in.)	43.24 x 20.49 x 6.55 cm (17.02 x 8.07 x 2.58 in.)
Carton Lot	3 pcs					

Function	CS1182H	CS1184H	CS1188H	CS1142H	CS1144H	CS1148H
Ports	2	4	8	2	4	8
PC Video Connector	HDMI					
Console Video Connector	HDMI					
Number of Displays	Single Display			Dual Display		
Video	Max. 3840 x 2160 @ 30Hz (UHD); 1920 x 1080 (FHD)			Max. 3840 x 2160 @ 30Hz (UHD); 1920 x 1080 (FHD)		
Console Keyboard / Mouse Interface	PS2/USB			PS2/USB		
CAC Port	Yes			Yes		
Audio	analog speaker only			analog speaker only		
Keyboard / Mouse Emulation	USB			USB		
I/P Rating	100–240V~ ; 50-60Hz; 1A			100–240V~ ; 50-60Hz; 1A		
Physical Properties						
Housing	Metal			Metal		
Weight	1.76 kg (3.88 lb)	1.76 kg (3.88 lb)	3.35 kg (7.38 lb)	2.06 kg (4.54 lb)	2.11 kg (4.65 lb)	3.21 kg (7.07 lb)
Dimensions (L x W x H)	33.50 x 16.39 x 4.40 cm (13.19 x 6.45 x 1.73 in.)	33.50 x 16.43 x 4.40 cm (13.19 x 6.47 x 1.73 in.)	43.24 x 20.49 x 6.55 cm (17.02 x 8.07 x 2.58 in.)	33.50 x 16.39 x 6.55 cm (13.19 x 6.45 x 2.58 in.)	33.50 x 16.39 x 6.55 cm (13.19 x 6.45 x 2.58 in.)	43.24 x 20.49 x 6.55 cm (17.02 x 8.07 x 2.58 in.)
Carton Lot	3 pcs					

Function	CS1182D	CS1184D	CS1188D	CS1142D	CS1144D	CS1148D
Ports	2	4	8	2	4	8
PC Video Connector	DVI					
Console Video Connector	DVI					
Number of Displays	Single Display			Dual Display		
Video	3840 x 2160 @ 30 Hz*; DVI Dual Link: 2560 x 1600; DVI Single Link: 1920 x 1200; DVI-A: 2048 x 1536			3840 x 2160 @ 30 Hz*; DVI Dual Link: 2560 x 1600; DVI Single Link: 1920 x 1200; DVI-A: 2048 x 1536		
Console Keyboard / Mouse Interface	PS2/USB			PS2/USB		
CAC Port	Yes			Yes		
Audio	analog speaker only			analog speaker only		
Keyboard / Mouse Emulation	USB			USB		
I/P Rating	100-240V~ ; 50-60Hz; 1A			100-240V~ ; 50-60Hz; 1A		
Physical Properties						
Housing	Metal			Metal		
Weight	1.79 kg (3.94 lb)	1.80 kg (3.96 lb)	3.35 kg (7.38 lb)	2.14 kg (4.71 lb)	2.18 kg (4.8 lb)	3.34 kg (7.36 lb)
Dimensions (L x W x H)	33.50 x 16.43 x 4.40 cm (13.19 x 6.47 x 1.73 in.)	33.50 x 16.43 x 4.40 cm (13.19 x 6.47 x 1.73 in.)	43.24 x 20.49 x 6.55 cm (17.02 x 8.07 x 2.58 in.)	33.50 x 16.39 x 6.55 cm (13.19 x 6.45 x 2.58 in.)	33.50 x 16.39 x 6.55 cm (13.19 x 6.45 x 2.58 in.)	43.24 x 20.49 x 6.55 cm (17.02 x 8.07 x 2.58 in.)
Carton Lot	3 pcs					

Note: * DVI Secure KVM Switches offer up to 3840 x 2160 @ 30Hz video output on compatible HDMI-interfaced monitors/computers with ATEN DVI-to-HDMI KVM cables

Secure KVM Cables



Image	Part No.	Product Name	Compatible products
	2L-7D02UDX2	1.8M USB DVI-D Dual Link Secure KVM Cable Kit	CS1188D, CS1184D, CS1182D
	2L-7D02DHX2	1.8M USB HDMI to DVI-D Secure KVM Cable Kit	CS1188D, CS1184D, CS1182D
	2L-7D02UDX3	1.8M USB DVI-D Dual Link Dual Display Secure KVM Cable Kit	CS1148D, CS1144D, CS1142D
	2L-7D02UHX4	1.8M USB HDMI Secure KVM Cable Kit	CS1188H, CS1184H, CS1182H
	2L-7D02UHX5	1.8M USB HDMI Dual Display Secure KVM Cable Kit	CS1148H, CS1144H, CS1142H
	2L-7D02UDPX4	1.8M USB DisplayPort Secure KVM Cable Kit	CS1188DP, CS1184DP, CS1182DP
	2L-7D02UDPX5	1.8M USB DisplayPort Dual Display Secure KVM Cable Kit	CS1148DP, CS1144DP, CS1142DP

Image	Part No.	Product Name	Compatible products
	2L-7D03UDX4	3M USB DVI-D Dual Link Secure KVM Cable Kit	CS1188D, CS1184D, CS1182D
	2L-7D03UDX5	3M USB DVI-D Dual Link Dual Display Secure KVM Cable Kit	CS1148D, CS1144D, CS1142D
	2L-7D03UHX4	3M USB HDMI Secure KVM Cable Kit	CS1188H, CS1184H, CS1182H
	2L-7D03UHX5	3M USB HDMI Dual Display Secure KVM Cable Kit	CCS1148H, CS1144H, CS1142H
	2L-7D03UDPX4	3M USB DisplayPort Secure KVM Cable Kit	CS1188DP, CS1184DP, CS1182DP
	2L-7D03UDPX5	3M USB DisplayPort Dual Display Secure KVM Cable Kit	CS1148DP, CS1144DP, CS1142DP

LCD KVM Switches

4

LCD KVM Switches

ATEN LCD KVM switches offer a space-saving, streamlined approach to KVM switch technology by integrating a TFT-LCD panel, full keyboard and touchpad in a 1U housing. The TFT-LCD display is built into the cover; the keyboard and touchpad are built into the base. Slide the KVM module out, lift the cover up, and you are ready to work.



- **Ultra Short Depth Design**

ATEN ultra short depth design is applied in both single rail and dual rail model, fits all 19" equipment cabinets, and is especially suitable for shallow racks and any computer room where space is at a premium.

- **Dual Rail Flexibility**

The dual rail design enables the LCD monitor, keyboard, and touchpad to operate independently of each other. To maximize space utilization, the keyboard and touchpad modules can slide back to "hideaway" when not in use, while the thin profile LCD monitor rotates back, flush against the rack, to allow for convenient monitoring of computer activity.

- **Exclusive LED Illumination Light**

ATEN's LCD KVM features an LED illumination light, designed to illuminate the keyboard and touchpad in a dark room. The LED illumination light is ON by default as you lift up the LCD and can be switched OFF by pushbutton if needed. The unique design serves to brighten low-light conditions and provide a more flexible working environment.

- **Enhanced Console Control**

The LCD KVM switches contain a second console to provide administrators with the convenience and flexibility of using a standard keyboard / monitor / mouse console. It also allows two users to share access and control of the servers.

- **Dual Interface – Multi Platform Support**

The LCD KVM switches support optional custom cables or converters with PS/2 and USB interfaces. The KVM Switches are designed for different OS (Windows, Mac, Sun, or Linux).

- **Space Efficient All-in-One Design**

ATEN's LCD KVM switches feature a retractable keyboard, LCD monitor and touchpad with an 8-or 16-port KVM switch with 1U housing.

- **Easy Installation Options**

All LCD KVM switches come with a Standard Rack Mount Kit. Standard Rack Mount installation requires two people. Single Person Easy Installation Rack Mount Kits are available as a separate purchase.

- **Convenient Security via Fingerprint Identification**

Each user can scan 1 to 4 of their fingers. (Models with Fingerprint Identification Reader only)

Note:

The features highlighted above are not available in all products. Please refer to each product page for more details. Product information is subject to change without prior notice.

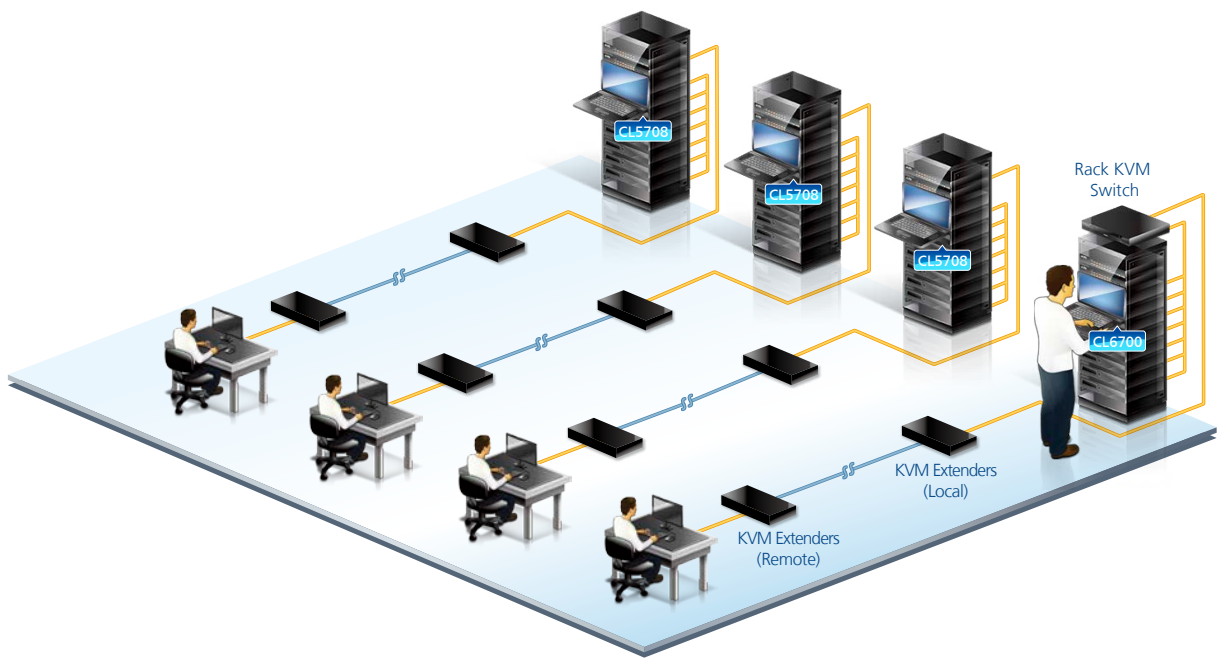

— Video / Keyboard / Mouse
 — Cat 5e Cable

Feature Comparison

Model No.		CL5708I*	CL5716I*
Backlit		LED	LED
TFT-LCD Size		CL5708IM: 17" CL5708IN: 19"	CL5716IM: 17" CL5716IN: 19"
Ports		8	16
Interface	Keyboard, Mouse	PS/2-USB	PS/2-USB
	Video	VGA	VGA
Expansion		128 (Daisy-chain)	256 (Daisy-chain)
Second Console		PS/2, USB, HDB-15 (SPHD)	PS/2, USB, HDB-15 (SPHD)
Platform Support		Windows, Linux, Mac, Sun	Windows, Linux, Mac, Sun
Single Rail/Dual Rail		Single Rail	Single Rail
Port Selection		OSD, Hotkey, Pushbutton	OSD, Hotkey, Pushbutton

Note: * CL5708I / CL5716I has over IP function.

Model No.		CL3800	CL3700	CL3100
Backlit		LED	LED	LED
LCD Module		CL3800NW: 18.5" (1920 x 1080 @ 60 Hz) CL3800NX: 18.5" (1366 x 768 @ 60 Hz)	CL3700NW: 18.5" (1920 x 1080 @ 60 Hz) CL3700NX: 18.5" (1366 x 768 @ 60 Hz)	CL3100NX: 18.5" (1366 x 768 @ 60 Hz)
Ports		1	1	1
Interface	Keyboard, Mouse	USB	USB	USB
	Video	HDMI, DVI-D, VGA	HDMI	VGA
Expansion		N/A	N/A	N/A
Second Console		USB, HDMI, DVI-D, HDB-15	USB, HDMI	USB, HDB-15
Platform Support		Windows, Linux, Mac, Sun	Windows, Linux, Mac, Sun	Windows, Linux, Mac, Sun
Single Rail/Dual Rail		Dual Rail	Single Rail	Single Rail
Console Selection		Hotkey	Hotkey	Hotkey

Model No.		CL6700	CL3000	CL5800	CL1000
Backlit		LED	LED	LED	LED
TFT-LCD Size		CL6700MW: 17.3"	CL3000N: 19"	CL5800N: 19"	CL1000M: 17" CL1000N: 19"
Ports		1	1	1	1
Interface	Keyboard, Mouse	USB	PS/2-USB	PS/2-USB	PS/2
	Video	HDMI, DVI-D, VGA	VGA	VGA	VGA
Expansion		N/A	N/A	N/A	N/A
Second Console		USB, HDMI, DVI-D, HDB-15	PS/2, USB, HDB-15	PS/2, USB, HDB-15	N/A
Platform Support		Windows, Linux, Mac, Sun	Windows, Linux, Mac, Sun	Windows, Linux, Mac, Sun	Windows, Linux
Single Rail/Dual Rail		Single Rail	Single Rail	Dual Rail	Single Rail
Console Selection		Hotkey	Hotkey	Hotkey	N/A

Model No.		CL6708	CL1308	CL1316
Backlit		LED	LED	LED
TFT-LCD Size		CL6708MW: 17.3"	CL1308N: 19"	CL1316N: 19"
Ports		8	8	16
Interface	Keyboard, Mouse	USB	PS/2-USB	PS/2-USB
	Video	DVI-I	VGA	VGA
Expansion		64 (Cascade)	128 (Cascade)	256 (Cascade)
Second Console		USB, DVI-I	N/A	N/A
Platform Support		Windows, Linux, Mac, Sun	Windows, Linux, Mac, Sun	Windows, Linux, Mac, Sun
Single Rail/Dual Rail		Single Rail	Single Rail	Single Rail
Port Selection		OSD, Hotkey, Pushbutton	OSD, Hotkey, Pushbutton	OSD, Hotkey, Pushbutton

Model No.		CL5808	CL5816
Backlit		LED	LED
TFT-LCD Size		CL5808N: 19"	CL5816N: 19"
Ports		8	16
Interface	Keyboard, Mouse	PS/2 & USB	PS/2 & USB
	Video	VGA	VGA
Expansion		256 (Daisy-chain)	512 (Daisy-chain)
Second Console		PS/2, USB, HDB-15 (SPHD)	PS/2, USB, HDB-15 (SPHD)
Platform Support		Windows, Linux, Mac, Sun	Windows, Linux, Mac, Sun
Single Rail/Dual Rail		Dual Rail	Dual Rail
Port Selection		OSD, Hotkey, Pushbutton	OSD, Hotkey, Pushbutton

Model No.		CL5708*	CL5716*	CL1008	CL1016
Backlit		LED	LED	LED	LED
TFT-LCD Size		CL5708M: 17" CL5708N: 19"	CL5716M: 17" CL5716N: 19"	CL1008M: 17"	CL1016M: 17"
Ports		8	16	8	16
Interface	Keyboard, Mouse	PS/2-USB	PS/2-USB	PS/2	PS/2
	Video	VGA	VGA	VGA	VGA
Expansion		256 (Daisy-chain)	512 (Daisy-chain)	128 (Daisy-chain)	256 (Daisy-chain)
Second Console		PS/2, USB, HDB-15 (SPHD)	PS/2, USB, HDB-15 (SPHD)	N/A	N/A
Platform Support		Windows, Linux, Mac, Sun	Windows, Linux, Mac, Sun	Windows, Linux	Windows, Linux
Single Rail/Dual Rail		Single Rail	Single Rail	Single Rail	Single Rail
Port Selection		OSD, Hotkey, Pushbutton	OSD, Hotkey, Pushbutton	OSD, Hotkey, Pushbutton	OSD, Hotkey, Pushbutton

Note: * Models with Fingerprint Identification Reader Only.

CL5708I / CL5716I

8 / 16-Port PS/2-USB VGA LCD KVM over IP Switch with Daisy-Chain Port and USB Peripheral Support



4

LCD KVM Switches

Front



Rear

• CL5708I



• CL5716I



Features

- [Exclusive LED illumination light - designed by ATEN to illuminate the keyboard and touchpad to allow visibility in low-light conditions](#)
- Daisy chain up to 15 additional units – control up to 128/256 computers from a single console
- Integrated KVM console with 17" or 19" LED-backlit LCD monitor in a single rail housing
- 1 remote bus for KVM over IP access - allowing IT administrators to remotely monitor and control up to 8/16 servers
- Mouse DynaSync™ - automatically synchronizes the local and remote mouse movements
- Front panel USB port allows each computer to access USB peripherals
- Dual Interface - supports computers and console with PS/2 or USB keyboards and mice
- Supports multimedia USB keyboards for Windows, Mac and Sun
- Superior video quality - up to 1280 x 1024 @ 75Hz; DDC2B for the local LCD module; up to 1920 x 1200 @ 60Hz / 24 bit color depth for remote sessions
- Adjustable video quality for flexible adaptation to diverse network environments
- Two level password security - only authorized users can view and control computers; up to 64 user accounts with separate profiles for each
- Integration with CC2000 Centralized Management Software
- Broadcast mode: operations from the keyboard can be simultaneously performed on all selected computers on the installation (software installation, system-wide shutdown, etc.)
- Panel array mode enables user to monitor multiple servers from single screen at the same time
- IPv6 capable
- Message board – convenient communication for remote users
- Secure keyboard / mouse / video transmission via RC4 128 bit encryption
- Supports TLS 1.2 data encryption and RSA 2048 bit certificates for secure user logins from a browser
- External (Remote) authentication support: RADIUS, LDAP, LDAPS, MS Active Directory
- Support for IP/MAC Filter
- Local and remote access logged and authenticated
- BIOS-level access
- Keyboard Language support: English(US), English(UK), French, German, German(Swiss), Greek, Hungarian, Italian, Japanese, Korean, Russian, Spanish, Swedish, Traditional Chinese and Turkish

Specifications

Function	CL5708IM / CL5708IN	CL5716IM / CL5716IN
Computer Connections		
Direct	8	16
Maximum	128 (via Daisy-chain)	256 (via Daisy-chain)
Console Connections		
Local / Remote	1	
Port Selection	OSD, Hotkey, Pushbuttons	
Connectors		
External Console Ports	1 x SPHD-18 Male (Yellow)	
External Mouse Port	1 x USB Type A Female	
KVM Ports	8 x SPHD-17 Female	16 x SPHD-17 Female
Daisy Chain Ports	1 x DB-25 Male	
Firmware Upgrade	1 x RJ-11 Female	
Power	1 x 3-prong AC Socket	
USB Port	1 x USB Type A Female	
LAN Ports	1 x RJ-45 Femae	
LEDs		
Port ID	1 x 2-digit, 7-segment (Yellow)	
Station ID	1 x 2-digit, 7-segment (Yellow)	
Power	1 (Dark Green)	
Lock	1 x Num Lock (Green), 1 x Caps Lock (Green), 1 x Scroll Lock (Green)	
Online	8 (Orange)	16 (Orange)
10/100 Mbps	1 (Orange / Green)	
Input Video Resolution	1920 x 1200 @ 60Hz	
LCD Module	CL5708IM: 17", CL5708IN: 19" (1280 x 1024 @ 75Hz)	CL5716IM: 17", CL5716IN: 19" (1280 x 1024 @ 75Hz)
Emulation		
Keyboard / Mouse	PS/2, USB	
Maximum Input Power Rating	100-240V AC, 50/60Hz, 1A	
Power Consumption	CL5708IM: 110V: 26.8W; 220V: 27.7W CL5708IN: 110V: 29W; 220V: 29.8W	CL5716IM: 110V: 26.8W; 220V: 27.7W CL5716IN: 110V: 30.8W; 220V: 31.8W
Environmental		
Operating Temperature	0-50°C	
Storage Temperature	-20-60°C	
Humidity	0-85% RH, Non-condensing	
Physical Properties		
Housing	Metal + Plastic	
Weight	CL5708IM: 13.49 kg (29.71 lb) CL5708IN: 13.41 kg (29.54 lb)	CL5716IM: 13.61 kg (29.98 lb) CL5716IN: 13.67 kg (30.11 lb)
Dimensions (L x W x H)	CL5708IM: 48.00 x 64.27 x 4.40 cm (18.9 x 25.3 x 1.73 in.) CL5708IN: 48.00 x 68.92 x 4.40 cm (18.9 x 27.13 x 1.73 in.)	CL5716IM: 48.00 x 64.27 x 4.40 cm (18.9 x 25.3 x 1.73 in.) CL5716IN: 48.00 x 68.92 x 4.40 cm (18.9 x 27.13 x 1.73 in.)
Carton Lot	1 pc	
Included Accessories	2x USB KVM Cables; 1x Custom Console Cable; 1x Firmware Upgrade Cable; 1x Power Cord; 1x Standard Mounting Kit	

Optional Accessories

Type	Part No. / Spec.	Page No.
USB KVM Cables	2L-5201U (1.2 m), 2L-5202U (1.8 m), 2L-5203U (3 m), 2L-5205U (5 m)	12-2 N
PS/2 KVM Cables	2L-5201P (1.2 m), 2L-5202P / 2L-5702P (1.8 m), 2L-5203P (3 m), 2L-5206P (6 m)	12-1 C 12-1 D
Daisy-chain Cables	2L-1700 (0.6 m), 2L-1701 (1.8 m), 2L-1703 (3 m), 2L-1705 (5 m), 2L-1715 (15 m)	12-3 V
Rack Mount Kits	CL5708IM / CL5716IM: 2X-010G (68-105 cm), 2X-011G (52-70 cm), 2X-012G (68-105 cm) CL5708IN / CL5716IN: 2X-010G (70-105 cm), 2X-011G (57-70 cm), 2X-012G (68-105 cm)	4-20

CL3800

1U Ultra Short Depth Dual Rail WideScreen LCD Console with USB Peripheral Support (USB / HDMI / DVI / VGA)



Shared Access 2 Local Users	2nd Console HDMI, DVI, VGA, USB	External Mouse USB	Audio Enabled	LED Monitor 18.5"	LED Illumination Light
--------------------------------	------------------------------------	-----------------------	---------------	----------------------	------------------------

4

LCD KVM Switches

Front



Rear



Features

- [Exclusive LED illumination light](#) - designed by ATEN to illuminate the keyboard and touchpad to allow visibility in low-light conditions
- [Dual rail design](#) allows LED-backlit LCD monitor and keyboard/touchpad modules to operate independently
- Integrated KVM console with short depth dual rail design and a 18.5" LED-backlit LCD monitor allows you to work with your rack-mounting equipment in narrow spaces
- Supports 3 types of video inputs (HDMI / DVI / VGA) - provides flexibility of installation
- Supports an external console with USB / HDMI / DVI / VGA connectors for flexible operation
- Additional hot-pluggable USB mouse port on front panel (also functions as a USB peripheral port)
- Standard 105-key keyboard
- Keyboard Language support: English(US), English(UK), French, German, German(Swiss), Greek, Hungarian, Italian, Japanese, Korean, Russian, Spanish, Swedish, Traditional Chinese and Turkish

Specifications

Function	CL3800NW	CL3800NX
Computer Connections	1	
Console Selection	Hotkey	
Connectors		
External Console Ports	1 x HDMI Female, 1 x DVI-D Female (White), 1 x HDB-15 Female (Blue), 2 x USB Type A Female, 1 x 3.5mm Audio Jack Female (Green)	
KVM Ports	1 x HDMI Female, 1 x DVI-D Female (White), 1 x HDB-15 Male (Blue), 1 x USB Type B Female, 1 x 3.5mm Audio Jack Female (Green)	
USB Port	1 x USB Type A Female	
Firmware Upgrade	1 x 3.5mm Audio Jack Female (Black)	
Power	1 x 3-prong AC Socket	
LEDs		
Power	1 x KVM Console (Dark Green), 1 x LCD (Orange)	
Lock	1 x Num Lock (Green), 1 x Caps Lock (Green), 1 x Scroll Lock (Green)	
Input Video Resolution	1920 x 1200 @ 60 Hz, DDC2B	
LCD Module	18.5" (1920 x 1080 @ 60Hz)	18.5" (1366 x 768 @ 60Hz)
Emulation		
Keyboard / Mouse	USB	
Maximum Input Power Rating	100–240V AC, 50/60Hz, 1A	
Power Consumption	110V: 26.6W 220V: 26.8W	110V: 18.3W 220V: 17.8W
Environmental		
Operating Temperature	0-40°C	
Storage Temperature	-20-60°C	
Humidity	0 - 80% RH, Non-condensing	
Physical Properties		
Housing	Metal + Plastic	
Weight	9.61 kg (21.17 lb)	9.79 kg (21.56 lb)
Dimensions (L x W x H)	48.06 x 51.42 x 4.28 cm (18.92 x 20.24 x 1.69 in.)	
Body Dimensions (L x W x H)	44.92 X 46.74 X 4.28 cm (17.69 x 18.40 x 1.69 in.)	
Carton Lot	1 pc	
Included Accessories	1x USB HDMI KVM Cable; 1x Firmware Upgrade Cable; 1x Power Cord; 1x Standard Mounting Kit	

Note: Body Dimensions exclude I/O ports, handles, and mounting brackets.

Optional Accessories

Type	Part No. / Spec.	Page No.
USB HDMI KVM Cable	2L-7D02UH (1.8 m)	12-3 T
USB DVI KVM Cables	2L-7D02U (1.8 m), 2L-7D03U (3 m), 2L-7D05U (5 m)	12-3 O
USB HDMI to DVI-D KVM Cable	2L-7D02DH (1.8 m)	12-3 S
Rack Mount Kits	2X-041G (45-70 cm), 2X-042G (68-105 cm)	4-20

CL3700

1U Ultra Short Depth Single Rail WideScreen LCD Console with USB Peripheral Support (USB / HDMI)

Shared Access 2 Local Users	2 nd Console HDMI, USB	External Mouse USB	LED Monitor 18.5"	LED Illumination Light
--------------------------------	--------------------------------------	-----------------------	----------------------	------------------------

Front



Rear



Features

- [Exclusive LED illumination light - designed by ATEN to illuminate the keyboard and touchpad to allow visibility in low-light conditions](#)
- Integrated KVM console with short depth single rail design and a 18.5" LED-backlit LCD monitor allows you to work with your rack-mounting equipment in narrow spaces
- Supports HDMI video input, USB keyboard and mouse
- Supports an external console with USB / HDMI connectors
- Additional hot-pluggable USB mouse port on front panel (also functions as a USB peripheral port)
- Standard 105-key keyboard
- Keyboard Language support: English(US), English(UK), French, German, German(Swiss), Greek, Hungarian, Italian, Japanese, Korean, Russian, Spanish, Swedish, Traditional Chinese and Turkish

Specifications

Function	CL3700NW	CL3700NX
Computer Connections	1	
Console Selection	Hotkey	
Connectors		
External Console Ports	1 x HDMI Female, 2 x USB Type A Female	
KVM Ports	1 x HDMI Female, 1 x USB Type B Female	
USB Port	1 x USB Type A Female	
Firmware Upgrade	1 x 3.5mm Audio Jack Female (Black)	
Power	1 x 3-prong AC Socket	
LEDs		
Power	1 x KVM Console (Dark Green), 1 x LCD (Orange)	
Lock	1 x Num Lock (Green), 1 x Caps Lock (Green), 1 x Scroll Lock (Green)	
Input Video Resolution	1920 x 1200 @ 60Hz	
LCD Module	18.5" (1920 x 1080 @ 60Hz)	18.5" (1366 x 768 @ 60Hz)
Emulation		
Keyboard / Mouse	USB	
Maximum Input Power Rating	100–240V AC, 50/60 Hz, 1A	
Power Consumption	110V: 23.3W; 220V: 23.9W	110V: 13.6W; 220V: 13.5W
Environmental		
Operating Temperature	0–40°C	
Storage Temperature	-20–60°C	
Humidity	0–80% RH, Non-condensing	
Physical Properties		
Housing	Metal + Plastic	
Weight	9.01 kg (19.85 lb)	9.03 kg (19.89 lb)
Dimensions (L x W x H)	48.06 x 47.70 x 4.28 cm (18.92 x 18.78 x 1.69 in.)	
Body Dimensions (L x W x H)	44.92 x 43.00 x 4.28 cm (17.69 x 16.93 x 1.69 in.)	
Carton Lot	1 pc	
Included Accessories	1x USB HDMI KVM Cable; 1x Firmware Upgrade Cable; 1x Power Cord; 1x Standard Mounting Kit	

Note: Body Dimensions exclude I/O ports, handles, and mounting brackets.

Optional Accessories

Type	Part No. / Spec.	Page No.
USB HDMI KVM Cable	2L-7D02UH (1.8 m)	12-3 T
Rack Mount Kits	2X-041G (42-70 cm), 2X-042G (68-105 cm)	4-20

CL3100

1U Ultra Short Depth Single Rail WideScreen LCD Console with USB Peripheral Support (USB / VGA)



4

LCD KVM Switches

Front



Rear



Features

- [Exclusive LED illumination light - designed by ATEN to illuminate the keyboard and touchpad to allow visibility in low-light conditions](#)
- Integrated KVM console with short depth single rail design and a 18.5" LED-backlit LCD monitor allows you to work with your rack-mounting equipment in narrow spaces
- Supports an external console with USB / VGA connectors
- Additional hot-pluggable USB mouse port on front panel (also functions as a USB peripheral port)
- Standard 105-key keyboard
- Keyboard Language support: English(US), English(UK), French, German, German(Swiss), Greek, Hungarian, Italian, Japanese, Korean, Russian, Spanish, Swedish, Traditional Chinese and Turkish

Specifications

Function	CL3100NX
Computer Connections	1
Console Selection	Hotkey
Connectors	
External Console Ports	1 x HDB-15 Female (Blue) 2 x USB Type A Female 1 x 3.5mm Audio Jack Female (Green)
KVM Ports	1 x SPHD Female (Yellow) 1 x 3.5mm Audio Jack Female (Green)
USB Port	1 x USB Type A Female
Firmware Upgrade	1 x 3.5mm Audio Jack Female (Black)
Power	1 x 3-prong AC Socket
LEDs	
Power	1 x KVM Console (Dark Green) 1 x LCD (Orange)
Lock	1 x Num Lock (Green) 1 x Caps Lock (Green) 1 x Scroll Lock (Green)
Input Video Resolution	1920 x 1200 @ 60Hz
LCD Module	18.5" (1366 x 768 @ 60Hz)
Emulation	
Keyboard / Mouse	USB
Maximum Input Power Rating	100-240V AC, 50/60Hz, 1A
Power Consumption	110V: 13.8W 220V: 14.1W
Environmental	
Operating Temperature	0-40°C
Storage Temperature	-20-60°C
Humidity	0-80% RH, Non-condensing
Physical Properties	
Housing	Metal + Plastic
Weight	9.07 kg (19.98 lb)
Dimensions (L x W x H)	48.06 x 47.70 x 4.28 cm (18.92 x 18.78 x 1.69 in.)
Body Dimensions (L x W x H)	44.92 x 43.00 x 4.28 cm (17.69 x 16.93 x 1.69 in.)
Carton Lot	1 pc
Included Accessories	1x USB KVM Cable; 1x Firmware Upgrade Cable; 1x Power Cord; 1x Standard Mounting Kit

Note: Body Dimensions exclude I/O ports, handles, and mounting brackets.

Optional Accessories

Type	Part No. / Spec.	Page No.
USB KVM Cables	2L-5201U / 2L-5301U (1.2 m)	12-2 L 12-2 N
	2L-5202U / 2L-5302U (1.8 m)	
	2L-5203U / 2L-5303U (3 m)	
	2L-5205U / 2L-5305U (5 m)	
Rack Mount Kits	2X-041G (42-70 cm), 2X-042G (68-105 cm)	4-20

CL6700

Single Rail WideScreen Full HD LCD Console with USB Peripheral Support (USB / HDMI / DVI / VGA)



Front



Rear



Features

- [Exclusive LED illumination light - designed by ATEN to illuminate the keyboard and touchpad to allow visibility in low-light conditions](#)
- Integrated DVI KVM console with a 17.3" Widescreen Full HD LED-backlit LCD monitor in a single rail housing
- Supports an external console with USB / HDMI / DVI / VGA connectors
- Additional hot-pluggable USB mouse port on front panel (also functions as a USB peripheral port)
- Adjustable depth to fit within the rack
- DDC emulation – video settings of attached computers are automatically adjusted for optimal output to the monitor
- Standard 105-key keyboard
- Keyboard Language support: English(US), English(UK), French, German, German(Swiss), Greek, Hungarian, Italian, Japanese, Korean, Russian, Spanish, Swedish, Traditional Chinese and Turkish

Specifications

Function	CL6700MW
Computer Connections	1
Console Selection	Hotkey
Connectors	
External Console Ports	1 x HDMI Female, 1 x DVI-D Female (White), 1 x HDB-15 Female (Blue), 2 x USB Type A Female, 1 x 3.5 mm Audio Jack Female (Green)
KVM Ports	1 x HDMI Female, 1 x DVI-D Female (White), 1 x HDB-15 Male (Blue), 1 x USB Type B Female, 1 x 3.5 mm Audio Jack Female (Green)
USB Port	1 x USB Type A Female
Firmware Upgrade	1 x RJ-11 Female
Power	1 x 3-prong AC Socket
LEDs	
Power	1 x KVM Console (Dark Green), 1 x LCD (Orange)
Lock	1 x Num Lock (Green) 1 x Caps Lock (Green) 1 x Scroll Lock (Green)
Input Video Resolution	1920 x 1200 @ 60Hz, DDC2B
LCD Module	17.3" (1920 x 1080 @ 60Hz)
Emulation	
Keyboard / Mouse	USB
Maximum Input Power Rating	100–240V AC, 50/60Hz; 1A
Power Consumption	110V: 21.2W 220V: 20.8W
Environmental	
Operating Temperature	0-40°C
Storage Temperature	-20-60°C
Humidity	0 - 80% RH, Non-condensing
Physical Properties	
Housing	Metal
Weight	11.38 kg (25.07 lb)
Dimensions (L x W x H)	48.00 x 58.92 x 4.40 cm (18.9 x 23.2 x 1.73 in.)
Carton Lot	1 pc
Included Accessories	1x USB DVI KVM Cable; 1x Firmware Upgrade Cable; 1x Power Cord; 1x Standard Mounting Kit

Optional Accessories

Type	Part No. / Spec.	Page No.
USB HDMI KVM Cable	2L-7D02UH (1.8 m)	12-3 T
USB DVI-D Single Link KVM Cables	2L-7D02U (1.8 m), 2L-7D03U (3 m), 2L-7D05U (5 m)	12-3 O
USB HDMI to DVI-D KVM Cable	2L-7D02DH (1.8 m)	12-3 S
Rack Mount Kits	2X-010G (70-105 cm), 2X-011G (57-70 cm), 2X-012G (68-105 cm)	4-20

CL3000

Lightweight PS/2-USB VGA LCD Console with USB Peripheral Support



Front



Rear



Features

- [Exclusive LED illumination light - designed by ATEN to illuminate the keyboard and touchpad to allow visibility in low-light conditions](#)
- MIL-STD-810G Certified
- Green power LED-backlit LCD monitor saves energy
- Lightweight aluminum design for easier installation
- Integrated KVM console with a 19" LED-backlit LCD monitor in a single rail housing
- Additional hot-pluggable USB mouse port on front panel (also functions as a USB peripheral port)
- 1U high mountable rack
- Standard 105-key keyboard
- Keyboard Language support: English(US), English(UK), French, German, German(Swiss), Greek, Hungarian, Italian, Japanese, Korean, Russian, Spanish, Swedish, Traditional Chinese and Turkish

Specifications

Function	CL3000N
Computer Connections	1
Console Selection	Hotkey
Connectors	
External Console Ports	1 x HDB-15 Female (Blue), 2 x USB Type A Female, 1 x 6-pin Mini-DIN Female (Purple), 1 x 6-pin Mini-DIN Female (Green)
KVM Ports	1 x SPHD-18 Female (Yellow)
USB Port	1 x USB Type A Female
Firmware Upgrade	1 x RJ-11 Female
Power	1 x 3-prong AC Socket
LEDs	
Power	1 x KVM Console (Dark Green), 1 x LCD (Orange)
Lock	1 x Num Lock (Green) 1 x Caps Lock (Green) 1 x Scroll Lock (Green)
Input Video Resolution	1920 x 1200 @ 60Hz
LCD Module	19" (1280 x 1024 @ 75Hz, DDC2B)
Emulation	
Keyboard / Mouse	PS/2, USB
Maximum Input Power Rating	100–240V AC, 50/60Hz, 1A
Power Consumption	110V: 23.8W 220V: 25.4W
Random Vibration Resistant Test	MIL-STD-810G Certified Test Conditions: <ul style="list-style-type: none"> • Frequency Range: 5-500Hz • Grams: Value X, Y axis 0.76Grms, Z axis 1.07Grms • Test Duration: 1 hour/per axis
Environmental	
Operating Temperature	0–50°C
Storage Temperature	-20–60°C
Humidity	0–80% RH, Non-condensing
Physical Properties	
Housing	Aluminum
Weight	9.00 kg (19.82 lb)
Dimensions (L x W x H)	48.00 x 58.92 x 4.40 cm (18.9 x 23.2 x 1.73 in.)
Carton Lot	1 pc
Included Accessories	1x USB KVM Cable; 1x Power Cord; 1x Standard Mounting Kit

Optional Accessories

Type	Part No. / Spec.	Page No.
USB KVM Cables	2L-5201U (1.2 m), 2L-5202U (1.8 m), 2L-5203U (3 m), 2L-5205U (5 m)	12-2 N
PS/2 KVM Cables	2L-5201P (1.2 m), 2L-5202P / 2L-5702P (1.8 m), 2L-5203P (3 m), 2L-5206P (6 m)	12-1 C 12-1 D
Rack Mount Kits	2X-010G (70-105 cm), 2X-011G (57-70 cm), 2X-012G (68-105 cm)	4-20

CL5800

PS/2-USB VGA Dual Rail LCD Console with USB Peripheral Support



Front



Rear



Features

- [Exclusive LED illumination light - designed by ATEN to illuminate the keyboard and touchpad to allow visibility in low-light conditions](#)
- [Dual rail design](#) allows LED-backlit LCD monitor and keyboard / touchpad modules to operate independently
- Integrated KVM console with a 19" LED-backlit LCD monitor in a dual rail housing
- Additional hot-pluggable USB mouse port on front panel (also functions as a USB peripheral port)
- 1U high mountable rack
- Standard 105-key keyboard
- Keyboard Language support: English(US), English(UK), French, German, German(Swiss), Greek, Hungarian, Italian, Japanese, Korean, Russian, Spanish, Swedish, Traditional Chinese and Turkish

Specifications

Function	CL5800N
Computer Connections	1
Console Selection	Hotkey
Connectors	
External Console Ports	1 x HDB-15 Female (Blue) 2 x USB Type A Female 1 x 6-pin Mini-DIN Female (Purple) 1 x 6-pin Mini-DIN Female (Green)
KVM Ports	1 x SPHD-18 Female (Yellow)
USB Port	1 x USB Type A Female
Firmware Upgrade	1 x RJ-11 Female
Power	1 x 3-prong AC Socket
LEDs	
Power	1 x KVM Console (Dark Green) 1 x LCD (Orange)
Lock	1 x Num Lock (Green) 1 x Caps Lock (Green) 1 x Scroll Lock (Green)
Input Video Resolution	1920 x 1200 @ 60Hz
LCD Module	19" (1280 x 1024 @ 75Hz; DDC2B)
Emulation	
Keyboard / Mouse	PS/2, USB
Maximum Input Power Rating	100-240V AC, 50/60Hz, 1A
Power Consumption	110V: 22.2W 220V: 22.9W
Environmental	
Operating Temperature	0 – 50°C
Storage Temperature	-20 – 60°C
Humidity	0 - 80% RH, Non-condensing
Physical Properties	
Housing	Metal
Weight	14.27 kg (31.43 lb)
Dimensions (L x W x H)	48.00 x 68.04 x 4.40 cm (18.9 x 26.79 x 1.73 in.)
Carton Lot	1 pc
Included Accessories	1x USB KVM Cable; 1x Firmware Upgrade Cable; 1x Power Cord; 1x Standard Mounting Kit

Optional Accessories

Type	Part No. / Spec.	Page No.
USB KVM Cables	2L-5201U (1.2 m), 2L-5202U (1.8 m), 2L-5203U (3 m), 2L-5205U (5 m)	12-2 N
PS/2 KVM Cables	2L-5201P (1.2 m), 2L-5202P / 2L-5702P (1.8 m), 2L-5203P (3 m), 2L-5206P (6 m)	12-1 C 12-1 D
Rack Mount Kits	2X-010G (70-105 cm), 2X-011G (57-70 cm), 2X-012G (68-105 cm)	4-20

CL1000

17" / 19" PS/2 VGA LCD Console



4

LCD KVM Switches

Front

(17" / 19")



Rear

(17")



(19")

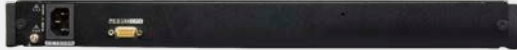

Features

- [Exclusive LED illumination light - designed by ATEN to illuminate the keyboard and touchpad to allow visibility in low-light conditions](#)
- The most popular ATEN LED-backlit LCD Console in a single rail housing
- 1U high mountable rack
- Adjustable depth to fit within a rack
- Standard 105-key keyboard
- Keyboard Language support: English(US), English(UK), French, German, German(Swiss), Greek, Hungarian, Italian, Japanese, Korean, Russian, Spanish, Swedish, Traditional Chinese and Turkish

Note: Custom KVM cables or converters are available for USB support

Specifications

Function	CL1000M	CL1000N
Computer Connections	1	
Connectors		
KVM (Computer) Ports	1 x SPHD Female (Yellow)	
Power	1 x 3-prong AC Socket	
LEDs		
Power	1 x KVM Console (Dark Green) 1 x LCD (Orange)	
Lock	1 x Num Lock (Green) 1 x Caps Lock (Green) 1 x Scroll Lock (Green)	
LCD Module	17" (1280 x 1024 @ 75Hz, DDC2B)	19" (1280 x 1024 @ 75Hz, DDC2B)
Emulation		
Keyboard / Mouse	PS/2	
Maximum Input Power Rating	100-240V AC, 50/60Hz, 1A	
Power Consumption	110V: 19.6W 220V: 21.3W	110V: 29.2W 220V: 29.3W
Environmental		
Operating Temperature	0 – 50°C	
Storage Temperature	-20 – 60°C	
Humidity	0 – 80% RH, Non-condensing	
Physical Properties		
Housing	Metal + Plastic	
Weight	12.02 kg (26.48 lb)	11.06 kg (24.36 lb)
Dimensions (L x W x H)	48.00 x 53.83 x 4.40 cm (18.9 x 21.19 x 1.73 in.)	48.30 x 58.52 x 4.40 cm (19.02 x 23.04 x 1.73 in.)
Carton Lot	1 pc	
Included Accessories	1x USB KVM Cable; 1x Power Cord; 1x Standard Mounting Kit	

Optional Accessories

Type	Part No. / Spec.	Page No.
PS/2 KVM Cables	2L-5201P (1.2 m), 2L-5202P / 2L-5702P (1.8 m), 2L-5203P (3 m), 2L-5206P (6 m)	12-1 C 12-1 D
Cables & Converters for USB Interface Support	2L-5202UP (1.8 m), 2L-5203UP (3 m), 2L-5205UP (5 m), 2L-5206UP (6 m) Supports Mac Keyboards Emulation: UC100KMA	12-1 E 9-3
Rack Mount Kits	CL1000M: 2X-010G (68-100 cm), 2X-011G (42-70 cm), 2X-012G (68-105 cm) CL1000N: 2X-023G (70-105 cm), 2X-024G (57-70 cm), 2X-025G (68-105 cm)	4-20

CL6708

8-Port DVI Full HD LCD KVM Switch



Front



Rear



Features

- [Exclusive LED illumination light - designed by ATEN to illuminate the keyboard and touchpad to allow visibility in low-light conditions](#)
- Integrated KVM console with a 17.3" LED-backlit LCD monitor in a single rail housing
- [Cascadable up to one level – control up to 64 computers](#)
- Supports USB external console
- Front panel USB port allows each computer to access USB peripherals (also functions as a USB peripheral port)
- Superior video quality – up to 1920 x 1080 @ 60Hz, DDC2B
- Two level access security – administrator, user
- Broadcast mode – operations simultaneously performed on all selected computers, such as software installation and upgrading, system wide shutdown, etc.
- Standard 105-key keyboard
- Keyboard Language support: English(US), English(UK), French, German, German(Swiss), Greek, Hungarian, Italian, Japanese, Korean, Russian, Spanish, Swedish, Traditional Chinese and Turkish

Specifications

Function	CL6708MW
Computer Connections	
Direct	8
Maximum	64
Port Selection	
	OSD, Hotkey, Pushbutton
Connectors	
External Console Ports	1 x DVI-I Female (White), 2 x USB Type A Female, 1 x 3.5 mm Audio Jack Female
KVM Ports	8 x DVI-I Female (White), 8 x USB Type A Female, 8 x 3.5 mm Audio Jack Female
Firmware Upgrade	1 x RJ-11 Female
Power	1 x 3-prong AC Socket
External Mouse Port	1 x USB Type A Female
LEDs	
Online	8 (Orange)
Selected	8 (Green)
Power	1 x KVM Power (Dark Green), 1 x LCD Power (Orange)
Lock	1 x Num Lock (Green) 1 x Caps Lock (Green) 1 x Scroll Lock (Green)
Input Video Resolution	1920 x 1200 @ 60Hz
LCD Module	17.3" (1920 x 1080 @ 60Hz, DDC2B)
Emulation	
Keyboard / Mouse	USB
Maximum Input Power Rating	100–240V AC, 50/60Hz, 1A
Power Consumption	110V: 29.4W 220V: 28.7W
Environmental	
Operating Temperature	0–40°C
Storage Temperature	-20–60°C
Humidity	0–80% RH, Non-condensing
Physical Properties	
Housing	Metal + Plastic
Weight	12.70 kg (27.97 lb)
Dimensions (L x W x H)	48.00 x 68.92 x 4.40 cm (18.9 x 27.13 x 1.73 in.)
Carton Lot	1 pc
Included Accessories	2x USB DVI-D Single Link KVM Cables; 1x Firmware Upgrade Cable; 1x Power Cord; 1x Standard Mounting Kit

Optional Accessories

Type	Part No. / Spec.	Page No.
USB DVI-D Single Link KVM Cables	2L-7D02U (1.8m), 2L-7D03U (3m), 2L-7D05U (5m)	12-3 O
USB DVI-I Single Link KVM Cables	2L-7D02UI (1.8m), 2L-7D03UI (3m)	12-3 O
USB HDMI to DVI-D KVM Cable	2L-7D02DH (1.8 m)	12-3 S
Rack Mount Kits	2X-010G (70-105 cm), 2X-011G (57-70 cm), 2X-012G (68-105 cm)	4-20

CL1308 / CL1316

8 / 16-Port PS/2-USB VGA LCD KVM Switch



Front



Rear

- CL1308



- CL1316



Features

- [Exclusive LED illumination light - designed by ATEN to illuminate the keyboard and touchpad to allow visibility in low-light conditions](#)
- The most cost effective ATEN 19" LED-backlit LCD KVM Switch
- Provides ease and flexibility for expanding server installation
- Supports most OS platforms and I/O peripherals
- Supports USB keyboards for Windows, Linux, Mac and Sun
- Two level access security – administrator, user
- Auto Scan – monitoring user-selected computers
- Broadcast mode – operations simultaneously performed on all selected computers, such as software installation and upgrading, system wide shutdown, etc.
- Keyboard Language support: English(US), English(UK), French, German, German(Swiss), Greek, Hungarian, Italian, Japanese, Korean, Russian, Spanish, Swedish, Traditional Chinese and Turkish

Specifications

Function	CL1308N	CL1316N
Computer Connections		
Direct	8	16
Maximum	128 (via Cascade)	256 (via Cascade)
Port Selection	OSD, Hotkeys, Pushbuttons	
Connectors		
KVM Ports	8 x SPHD-17 Female (Yellow)	16 x SPHD-17 Female (Yellow)
Firmware Upgrade	1 x RJ-11 Female	
Power	1 x 3-prong AC Socket	
LEDs		
Online	8 (Orange)	16 (Orange)
Selected	8 (Green)	16 (Green)
Power	1 (Dark Green), 1 (Orange)	
Lock	1 (Green)	
LCD Module	19" (1280 x 1024 @ 75Hz)	
Emulation		
Keyboard / Mouse	PS/2, USB	
Maximum Input Power Rating	100-240V AC, 50/60Hz, 1A	
Power Consumption	110V: 24.4W 220V: 24.7W	110V: 25.9W 220V: 26.1W
Environmental		
Operating Temperature	0 – 50°C	
Storage Temperature	-20 – 60°C	
Humidity	0 – 80% RH, Non-condensing	
Physical Properties		
Housing	Metal + Plastic	
Weight	12.59 kg (27.73 lb)	12.77 kg (28.13 lb)
Dimensions (L x W x H)	48.30 x 68.92 x 4.40 cm (19.02 x 27.13 x 1.73 in.)	
Carton Lot	1 pc	
Included Accessories	2x USB KVM Cables; 1x Firmware Upgrade Cable; 1x Power Cord; 1x Standard Mounting Kit	

Optional Accessories

Type	Part No. / Spec.	Page No.
USB KVM Cables	2L-5201U (1.2 m), 2L-5202U (1.8 m), 2L-5203U (3 m), 2L-5205U (5 m)	12-2 N
PS/2 KVM Cables	2L-5201P (1.2 m), 2L-5202P / 2L-5702P (1.8 m), 2L-5203P (3 m), 2L-5206P (6 m)	12-1 C 12-1 D
Rack Mount Kits	2X-023G (70-105 cm), 2X-024G (57-70 cm), 2X-025G (68-105 cm)	4-20

CL5808 / CL5816

8 / 16-Port PS/2-USB VGA Dual Rail LCD KVM Switch with Daisy-Chain Port and USB Peripheral Support



Front



Rear

- CL5808



- CL5816



Features

- [Exclusive LED illumination light - designed by ATEN to illuminate the keyboard and touchpad to allow visibility in low-light conditions](#)
- [Dual rail design](#) allows LED-backlit LCD monitor and keyboard / touchpad modules to operate independently
- Daisy-chain up to 31 additional units – control up to 256 / 512 computers from a single console
- Integrated KVM console with a 19" LED-backlit LCD monitor in a dual rail housing
- Front panel USB port allows each computer to access USB peripherals
- Supports computers with PS/2 or USB keyboards / mice
- Two level access security – administrator, user
- Broadcast mode – operations simultaneously performed on all selected computers, such as software installation and upgrading, system wide shutdown, etc.
- Keyboard Language support: English(US), English(UK), French, German, German(Swiss), Greek, Hungarian, Italian, Japanese, Korean, Russian, Spanish, Swedish, Traditional Chinese and Turkish; standard 105-key keyboard

Specifications

Function	CL5808N	CL5816N
Computer Connections		
Direct	8	16
Maximum	256 (via Daisy-chain)	512 (via Daisy-chain)
Port Selection OSD, Hotkey, Pushbutton		
Connectors		
External Console Ports	1 x SPHD-18 Male (Yellow)	
KVM Ports	8 x SPHD-17/18 Female (Yellow)	16 x SPHD-17/18 Female (Yellow)
Daisy Chain Ports	1 x DB-25 Male	
Firmware Upgrade	1 x RJ-11 Female	
Power	1 x 3-prong AC Socket	
External Mouse Port	1 x USB Type A Female	
LEDs		
Online	8 (Orange)	16 (Orange)
Selected	8 (Green)	16 (Green)
Station ID	2 (Orange)	
Power	1 (Dark Green)	
Lock	1 (Green)	
LCD Module	19" (1280 x 1024 @ 75Hz)	
Emulation		
Keyboard / Mouse	PS/2, USB	
Maximum Input Power Rating	100–240V AC, 50/60Hz, 1A	
Power Consumption	110V: 25.2W 220V: 27.2W	110V: 26.2W 220V: 27.6W
Environmental		
Operating Temperature	0–50°C	
Storage Temperature	-20–60°C	
Humidity	0–80% RH, Non-condensing	
Physical Properties		
Housing	Metal + Plastic	
Weight	14.48 kg (31.89 lb)	14.76 kg (32.51 lb)
Dimensions (L x W x H)	48.00 x 68.04 x 4.40 cm (18.9 x 26.79 x 1.73 in.)	
Carton Lot	1 pc	
Included Accessories	2x PS/2-USB KVM Cables; 1x Custom Console Cable; 1x Firmware Upgrade Cable; 1x Power Cord; 1x Standard Mounting Kit	

Optional Accessories

Type	Part No. / Spec.	Page No.
USB KVM Cables	2L-5201U (1.2 m), 2L-5202U (1.8 m), 2L-5203U (3 m), 2L-5205U (5 m)	12-2 N
PS/2-USB KVM Cables	2L-5301UP (1.2 m), 2L-5302UP (1.8 m), 2L-5303UP (3 m)	12-2 G
PS/2 KVM Cables	2L-5201P (1.2 m), 2L-5202P / 2L-5702P (1.8 m), 2L-5203P (3 m), 2L-5206P (6 m)	12-1 C 12-1 D
Daisy-chain Cables	2L-1700 (0.6 m), 2L-1701 (1.8 m), 2L-1703 (3 m), 2L-1705 (5 m), 2L-1715 (15 m)	12-3 V
Rack Mount Kits	2X-010G (70-105 cm), 2X-011G (57-70 cm), 2X-012G (68-105 cm)	4-20

CL5708 / CL5716

8 / 16-Port PS/2-USB VGA LCD KVM Switch with Daisy-Chain Port and USB Peripheral Support



Shared Access 2 Local Users	SPHD 2nd Console PS/2, USB	SPHD Computers PS/2, USB	USB Peripherals 1 Port	External Mouse USB	Expansion Daisy Chain	LED Monitor 17", 19"	LED Illumination Light
--------------------------------	----------------------------------	--------------------------------	---------------------------	-----------------------	--------------------------	-------------------------	------------------------

4

LCD KVM Switches

Front



Rear

• CL5708



• CL5716



Features

- [Exclusive LED illumination light - designed by ATEN to illuminate the keyboard and touchpad to allow visibility in low-light conditions](#)
- Daisy-chain up to 31 additional units – control up to 256 / 512 computers from a single console
- Integrated KVM console with a 17" / 19" LED-backlit LCD monitor in a single rail housing
- Optional Fingerprint Identification Reader*
- Supports a PS/2 or USB external console
- Front panel USB port allows each computer to access USB peripherals
- Dual Interface – supports computers with PS/2 or USB keyboard and mouse
- Supports USB keyboards for Windows, Linux, Mac and Sun
- Superior video quality – up to 1280 x 1024 @ 75Hz; DDC2B
- Two level access security – administrator, user
- Broadcast mode – operations simultaneously performed on all selected computers, such as software installation and upgrading, system wide shutdown, etc.
- Standard 105-key keyboard
- Keyboard Language support: English(US), English(UK), French, German, German(Swiss), Greek, Hungarian, Italian, Japanese, Korean, Russian, Spanish, Swedish, Traditional Chinese and Turkish

Note: * Models with fingerprint identification reader only

Specifications

Function	CL5708M / CL5708N	CL5716M / CL5716N
Computer Connections		
Direct	8	16
Maximum	256 (via Daisy-chain)	512 (via Daisy-chain)
Port Selection	OSD, Hotkey, Pushbuttons	
Connectors		
External Console Ports	1 x SPHD-18 Male (Yellow)	
KVM Ports	8 x SPHD-15/17 Female (Yellow)	16 x SPHD-15/17 Female (Yellow)
Daisy Chain Ports	1 x DB-25 Male	
Firmware Upgrade	1 x RJ-11 Female	
Power	1 x 3-prong AC Socket	
External Mouse Port	1 x USB Type A Female	
LEDs		
Port ID	2 (Yellow)	
Station ID	2 (Yellow)	
Online	8 (Orange)	16 (Orange)
Power	1 (Dark Green)	
Lock	1 x Num Lock (Green) 1 x Caps Lock (Green) 1 x Scroll Lock (Green)	
Input Video Resolution	1920 x 1200 @ 60 Hz	
LCD Module	CL5708M: 17" / CL5708N: 19" (1280 x 1024 @ 75Hz)	CL5716M: 17" / CL5716N: 19" (1280 x 1024 @ 75Hz)
Emulation		
Keyboard / Mouse	PS/2, USB	
Maximum Input Power Rating	100-240V AC, 50/60Hz, 1A	
Power Consumption	CL5708M: 110V: 23.9W; 220V: 25.1W CL5708N: 110V: 26.1W; 220V: 27.2W	CL5716M: 110V: 24.7W; 220V: 25.8W CL5716N: 110V: 26.9W; 220V: 27.9W
Environmental		
Operating Temperature	0-50°C	
Storage Temperature	-20-60°C	
Humidity	0-85% RH, Noncondensing	
Physical Properties		
Housing	Metal + Plastic	
Weight	CL5708M: 13.47 kg (29.67 lb) CL5708N: 13.39 kg (29.49 lb)	CL5716M: 13.59 kg (29.93 lb) CL5716N: 13.65 kg (30.09 lb)
Dimensions (L x W x H)	CL5708M: 48.00 x 64.27 x 4.40 cm (18.9 x 25.3 x 1.73 in.) CL5708N: 48.00 x 68.92 x 4.40 cm (18.9 x 27.13 x 1.73 in.)	CL5716M: 48.00 x 64.27 x 4.40 cm (18.9 x 25.3 x 1.73 in.) CL5716N: 48.00 x 68.92 x 4.40 cm (18.9 x 27.13 x 1.73 in.)
Carton Lot	1 pc	
Included Accessories	2x USB KVM Cables; 1x Custom Console Cable; 1x Firmware Upgrade Cable; 1x Power Cord; 1x Standard Mounting Kit	

Optional Accessories

Type	Part No. / Spec.	Page No.
USB KVM Cables	2L-5201U (1.2 m), 2L-5202U (1.8 m), 2L-5203U (3 m), 2L-5205U (5 m)	12-2 N
PS/2 KVM Cables	2L-5201P (1.2 m), 2L-5202P / 2L-5702P (1.8 m), 2L-5203P (3 m), 2L-5206P (6 m)	12-1 C 12-1 D
Daisy-chain Cables	2L-1700 (0.6 m), 2L-1701 (1.8 m), 2L-1703 (3 m), 2L-1705 (5 m), 2L-1715 (15 m)	12-3 V
Rack Mount Kits	CL5708M / CL5716M: 2X-010G (68-105 cm), 2X-011G (52-70 cm), 2X-012G (68-105 cm) CL5708N / CL5716N: 2X-010G (70-105 cm), 2X-011G (57-70 cm), 2X-012G (68-105 cm)	4-20

CL1008 / CL1016

8 / 16-Port PS/2 VGA LCD KVM Switch with Daisy-Chain Port



Front



Rear

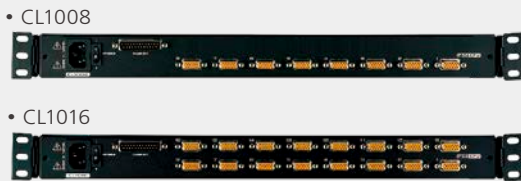

Features

- [Exclusive LED illumination light - designed by ATEN to illuminate the keyboard and touchpad to allow visibility in low-light conditions](#)
- Daisy-chain up to 15 additional units – control up to 128 / 256 computers from a single console
- Integrated KVM console with a 17" LED-backlit LCD monitor in a single rail housing
- Auto Scan feature for monitoring user-selected computers
- Broadcast mode – operations simultaneously performed on all selected computers, such as software installation and upgrading, system wide shutdown, etc.
- Two level access security – administrator, user
- Standard 105-key keyboard
- Keyboard Language support: English(US), English(UK), French, German, German(Swiss), Greek, Hungarian, Italian, Japanese, Korean, Russian, Spanish, Swedish , Traditional Chinese and Turkish

Specifications

Function	CL1008M	CL1016M
Computer Connections		
Direct	8	16
Maximum	128 (via Daisy-chain)	256 (via Daisy-chain)
Port Selection	OSD, Hotkey, Pushbuttons	
Connectors		
KVM Ports	8 x SPHD Female (Yellow)	16 x SPHD Female (Yellow)
Daisy Chain Ports	1 x DB-25 Male	
Firmware Upgrade	1 x RJ-11 Female	
Power	1 x 3-prong AC socket	
LEDs		
Online	8 (Orange)	16 (Orange)
Selected	8 (Green)	16 (Green)
Power	1 (Dark Green)	
Lock	1 (Green)	
LCD Module	17" (1280 x 1024 @ 75Hz; DDC2B)	
Emulation		
Keyboard / Mouse	PS/2	
Maximum Input Power Rating	100-240V AC, 50/60Hz, 1A	
Power Consumption	110V: 21.3W 220V: 23.6W	110V: 22.3W 220V: 24.5W
Environmental		
Operating Temperature	0 – 50°C	
Storage Temperature	-20 – 60°C	
Humidity	0 – 80% RH, Non-condensing	
Physical Properties		
Housing	Metal + Plastic	
Weight	13.34 kg (29.38 lb)	13.55 kg (29.85 lb)
Dimensions (L x W x H)	48.00 x 64.02 x 4.40 cm (18.9 x 25.2 x 1.73 in.)	
Carton Lot	1 pc	
Included Accessories	2x PS/2 KVM Cables; 1x Firmware Upgrade Cable; 1x Power Cord; 1x Standard Mounting Kit	

Optional Accessories

Type	Part No. / Spec.	Page No.
PS/2 KVM Cables	2L-5201P (1.2 m), 2L-5202P / 2L-5702P (1.8 m), 2L-5203P (3 m), 2L-5206P (6 m)	12-1 C 12-1 D
Cables & Converters for USB Interface Support	2L-5202UP (1.8 m), 2L-5203UP (3 m), 2L-5205UP (5 m), 2L-5206UP (6 m) Supports Mac Keyboards Emulation: UC100KMA	12-1 E 9-3
Daisy-chain Cables	2L-1700 (0.6 m), 2L-1701 (1.8 m), 2L-1703 (3 m), 2L-1705 (5 m), 2L-1715 (15 m)	12-3 V
Rack Mount Kits	2X-010G (68-105 cm), 2X-011G (52-70 cm), 2X-012G (68-105 cm)	4-20

Optional Rack Mount Kits

- Short (Standard)



- Standard Long



- Easy Installation Short



- Easy Installation Long



The following illustrations demonstrate just how easy it is to install your new LCD KVM Switch with the Easy Installation Rack Mount Kit.



1. Secure the side rails to the rack.

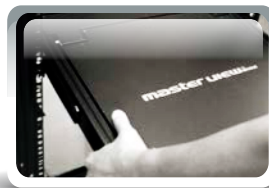

2. Slide the LCD KVM Switch onto the rails and secure it to the rack.

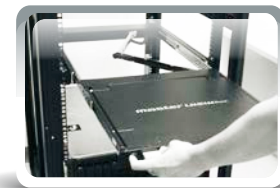

3. Now slide it out and you are ready to work.

Function	Rack Mount Kit	Depth (cm)
CL1000N, CL1308N, CL1316N	Standard Installation – Short (Standard)	52 - 85
	Standard Installation – Long (2X-023G)	70 - 105
	Easy Installation – Short (2X-024G)	57 - 70
	Easy Installation – Long (2X-025G)	68 - 105
CL3000N, CL5800N, CL6700MW, CL6708MW, CL5708N, CL5716N, CL5808N, CL5816N, CL5708IN, CL5716IN	Standard Installation – Short (Standard)	52 - 85
	Standard Installation – Long (2X-010G)	70 - 105
	Easy Installation – Short (2X-011G)	57 - 70
	Easy Installation – Long (2X-012G)	68 - 105
CL1008M, CL1016M, CL5708M, CL5716M, CL5708IM, CL5716IM	Standard Installation – Short (Standard)	42 - 82
	Standard Installation – Long (2X-010G)	68 - 105
	Easy Installation – Short (2X-011G)	52 - 70
	Easy Installation – Long (2X-012G)	68 - 105
CL1000M	Standard Installation – Short (Standard)	42 - 72
	Standard Installation – Long (2X-010G)	68 - 100
	Easy Installation – Short (2X-011G)	42 - 70
	Easy Installation – Long (2X-012G)	68 - 105
CL3800	Standard Installation – Short (Standard)	47 - 75
	Easy Installation – Short (2X-041G)	45 - 70
	Easy Installation – Long (2X-042G)	68 - 105
CL3100, CL3700	Standard Installation – Short (Standard)	42 - 72
	Easy Installation – Short (2X-041G)	42 - 70
	Easy Installation – Long (2X-042G)	68 - 105

KVM Extenders

5

KVM Extenders

ATEN KVM Extenders allow your console to be located up to 20 km away from your computer or installation. This makes extenders ideal for data centers, libraries, construction sites, and factory production lines.

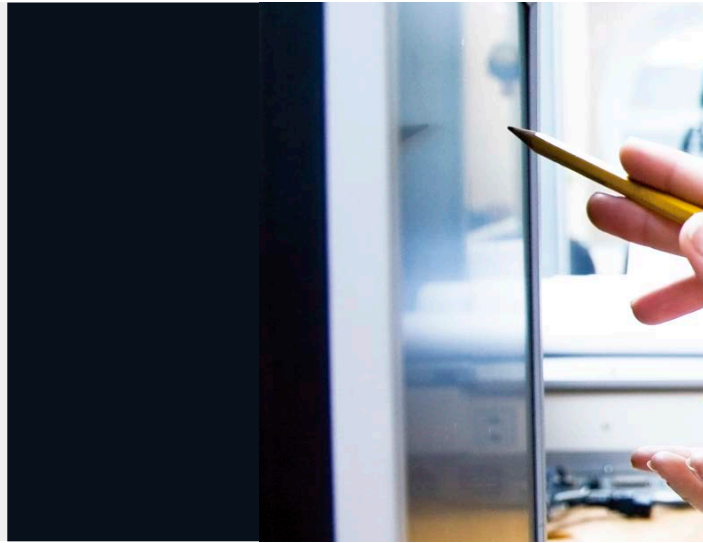

- **HDBaseT™**

ATEN integrates the latest HDBaseT™ technologies to deliver up to 4K video, stereo audio, USB keyboard/mouse/peripherals, Ethernet, and RS-232 signals up to 100 meters using a single Cat 6 / ATEN 2L-2910 Cat 6 cable.

- **Dual Console Control**

ATEN KVM extenders support a PS/2 or USB console at both the local and remote locations. The computer can be controlled from either console.

- **Real-time Monitoring over Greater Distance at Less Cost**

Use of inexpensive Cat 5e cables to connect the local and remote units enables longer distances between the units, even up to 300 m.

- **USB 2.0 Peripheral Support**

A dedicated USB port for USB flash drives can be used for file transfer operations between the drive and the computers. To make sure that security is maintained, a password is required before any files can be uploaded to the computers.

- **Superior CD Audio Quality**

Our technology converts analog signals to digital signals. This reduces electromagnetic interference and provides better CD audio quality at sample sizes of 24-bit, with sample rates up to 48 kHz.

- **RS-232 Serial Connectivity**

Incorporation of an RS-232 serial port provides the ability to integrate serial connectivity devices – such as barcode scanners, POS terminals, kiosk touch screens, etc. – as part of the extender installation.

- **Exceptional Video**

Automatic signal compensation is designed into the extender. The video signal strength is automatically adjusted to compensate for the distance between the computer and the console so that the quality of the display is preserved as you get farther from the source.

Another feature that compensates for distance is the Deskew Function, which automatically synchronizes the time delay of RGB signals to produce a crisp, clear image over long distance transmissions.

Note:

The features highlighted above are not available in all products. Please refer to each product page for more details. Product information is subject to change without prior notice.

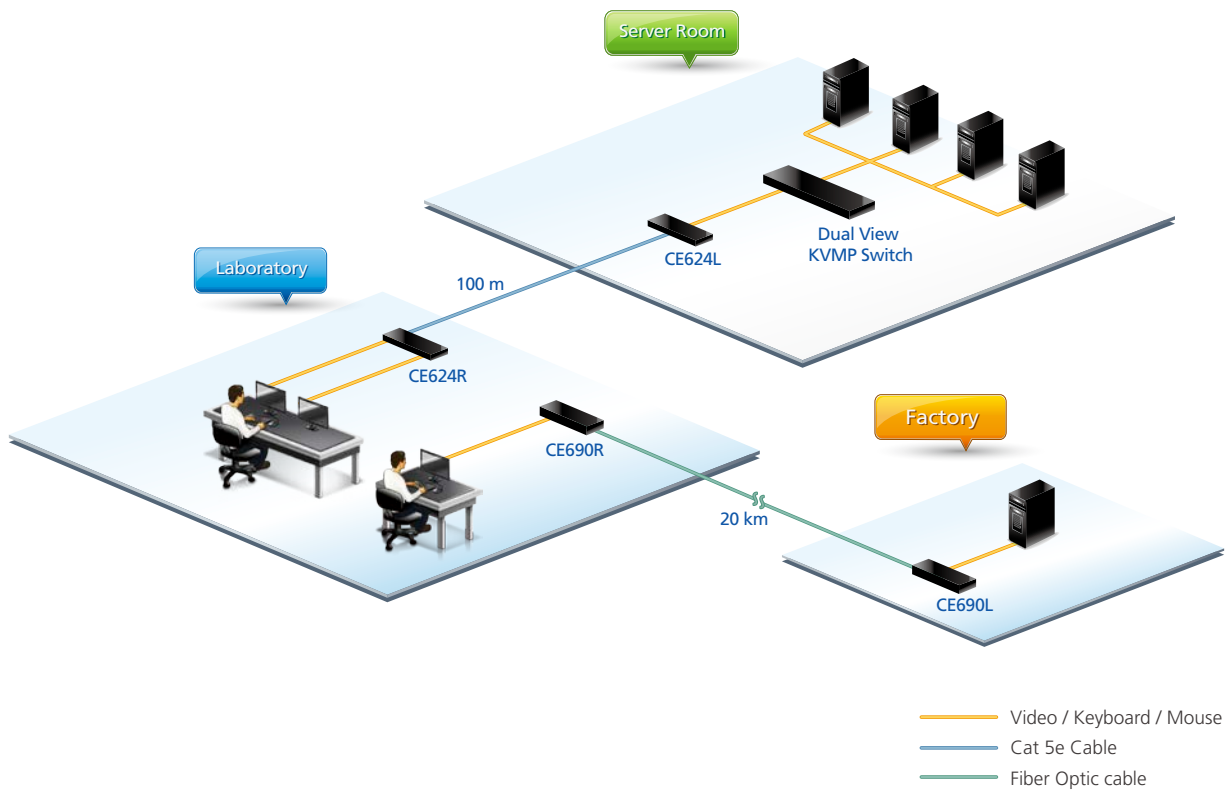

Feature Comparison

Model No.		CE920	CE820	CE624	CE620	CE611	CE610A
Distance		Standard: 100 m Long Reach Mode: 150 m		Standard: 100 m Long Reach Mode: 150 m		100 m	100 m
HDBaseT		HDBaseT 2.0	HDBaseT 2.0	HDBaseT 2.0	HDBaseT 2.0	HDBaseT	HDBaseT
Interface	Unit to Unit	Cat 6 / 6a / 2L-2910 x 1		Cat 6 / 6a / 2L-2910 x 1		Cat 6 / 6a / 2L-2910 x 1	Cat 6 / 6a / 2L-2910 x 1
	Keyboard, Mouse	USB	USB	USB	USB	USB	USB
	Video	DisplayPort	HDMI	DVI-D (Single Link)	DVI-D (Single Link)	DVI-D (Single Link)	DVI-D (Single Link)
Dual View		N/A	N/A	•	N/A	N/A	N/A
Audio		• (DisplayPort / Stereo)	• (HDMI / Stereo)	• (Stereo)	• (Stereo)	• (Stereo)	N/A
USB Channel		•	•	•	•	•	•
Ethernet Channel		•	•	N/A	N/A	N/A	N/A
RS-232 Channel		•	•	•	•	•	N/A
Local Console		N/A	N/A	N/A	N/A	N/A	N/A

Model No.		CE680	CE690	CE604	CE600	CE602
Distance		600 m	20 km	60 m	60 m	60 m
Interface	Unit to Unit	Fiber optic x 1	Fiber optic x 1	Cat 5e x 1 (or 2)	Cat 5e x 1 (or 2)	Cat 5e x 1 (or 2)
	Keyboard, Mouse	USB	USB	USB	USB	USB
	Video	DVI-D (Single Link)	DVI-D (Single Link)	DVI-D (Single Link)	DVI-D (Single Link)	DVI-D (Dual Link)
Dual View		N/A	N/A	•	N/A	N/A
Audio		• (Stereo)	• (Stereo)	• (Stereo)	• (Stereo)	• (Stereo)
Automatic Gain Control		N/A	N/A	N/A	N/A	N/A
Manual Gain Control		N/A	N/A	•	•	•
USB 2.0 Peripheral		N/A	N/A	N/A	N/A	N/A
USB Touch Panel		•	•	N/A	N/A	N/A
RS-232 Channel		•	•	•	•	•
Local Console		•	•	N/A	N/A	N/A

Model No.		CE800B	CE774	CE775	CE770	CE750A
Distance		250 m	150 m	300 m	300 m	200 m
Interface	Unit to Unit	Cat 5e x 1	Cat 5e x 2	Cat 5e x 2	Cat 5e x 1	Cat 5e x 1
	Keyboard, Mouse	USB	USB	USB	USB	USB
	Video	VGA	VGA	VGA	VGA	VGA
Dual View		N/A	•	•	N/A	N/A
Audio		• (Stereo)	• (Stereo)	• (Stereo)	• (Stereo)	• (Stereo)
Automatic Gain Control		•	•	•	•	•
Manual Gain Control		•	•	•	•	•
USB 2.0 Peripheral		•	N/A	N/A	N/A	N/A
USB Touch Panel		N/A	N/A	N/A	N/A	N/A
RS-232 Channel		N/A	•	•	•	•
Patented Deskew		N/A	N/A	•	•	N/A
Local Console		•	•	•	•	•

Model No.		CE700A	CE100	CE350	CE370	CE250A
Distance		150 m	100 m	150 m	300 m	150 m
Interface	Unit to Unit	Cat 5e x 1	Cat 5e x 1	Cat 5e x 1	Cat 5e x 1	Cat 5e x 1
	Keyboard, Mouse	USB	USB	PS/2	PS/2	PS/2
	Video	VGA	VGA	VGA	VGA	VGA
Dual View		N/A	N/A	N/A	N/A	N/A
Audio		N/A	N/A	• (Stereo)	• (Stereo)	N/A
Automatic Gain Control		•	N/A	•	•	•
Manual Gain Control		N/A	•	•	•	N/A
USB 2.0 Peripheral		N/A	N/A	N/A	N/A	N/A
USB Touch Panel		N/A	N/A	N/A	N/A	N/A
RS-232 Channel		N/A	N/A	•	•	N/A
Patented Deskew		N/A	N/A	N/A	•	N/A
Local Console		•	N/A	•	•	•

CE920

USB DisplayPort HDBaseT 2.0 KVM Extender

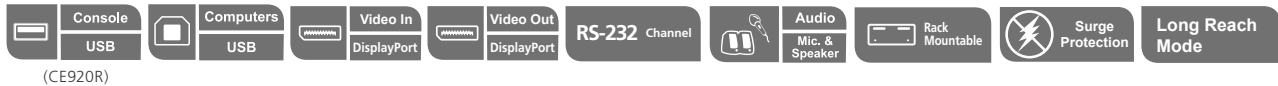

(CE920R)

Front

- CE920L



- CE920R



Rear

- CE920L



- CE920R



Features

- Supports HDBaseT 2.0 technology
 - Extends video, audio, USB, RS-232, and Ethernet signals via a single Cat6 / 6a / ATEN 2L-2910 Cat 6 cable
 - Enhanced bit error detection and correction to resist signal interference during high-quality video transmissions
 - Status detection and LED indication for HDBaseT signal transmission on remote unit
- EDID Buffer for smooth power-up and the highest quality display
- DisplayPort 1.1 (1080P, 4K); HDCP 1.4 compatible
- Long distance with superior video quality
 - HDBaseT Standard mode up to 4K @ 100 m (Cat 6 / 6a / 2L-2910)
 - HDBaseT Long-Reach mode up to 1080P @ 150 m
- Long Reach mode switch – switches between HDBaseT Standard and Long Reach modes in a snap
- USB 2.0 full speed ports – ensures fast transmission speeds for peripherals
- Supports individual 2-channel stereo audio for high-quality audio applications
- Supports PC wakeup function via single pushbutton
- Built-in 8KV / 15KV ESD protection (Contact voltage 8KV; Air voltage 15KV)

Specifications

Function	CE920L	CE920R
Connectors		
Console Ports	N/A	1 x DisplayPort Female (Black) 3 x USB Type A Female 1 x Mini Stereo Jack Female (Green) 1 x Mini Stereo Jack Female (Pink) 1 x RJ-45 Female (Black)
KVM Ports	1 x DisplayPort Female (Black) 1 x USB Type B Female (White) 1 x Mini Stereo Jack Female (Green) 1 x Mini Stereo Jack Female (Pink) 1 x RJ-45 Female (Black)	N/A
RS-232	1 x DB-9 Female (Black)	1 x DB-9 Male (Black)
Power	1 x DC Jack with locking	
Unit To Unit	1 x RJ-45 Female (Black)	
LEDs		
Power	1 (Green)	
Link	1 (Orange)	
Video Output	N/A	1 (Orange)
Video	Up to 4K @ 90 m (Cat 5e) / 100 m (Cat 6 / 6a / ATEN 2L-2910 Cat 6), 1080P @ 100 m (Cat 5e / 6 / 6a) *4K supported: 4096 x 2160 / 3840 x 2160 @ 60Hz (4:2:0); 4096 x 2160 / 3840 x 2160 @ 30Hz (4:4:4)	
Power Consumption	DC5V: 3.99W	DC5V: 6.74W
Environmental		
Operating Temperature	0–40°C	
Storage Temperature	-20–60°C	
Humidity	0–80% RH, Non-condensing	
Physical Properties		
Housing	Metal	
Weight	0.63 kg (1.39 lb)	0.64 kg (1.41 lb)
Dimensions (L x W x H)	18.20 x 12.19 x 2.87 cm (7.17 x 4.80 x 1.13 in.)	
Carton Lot	5 sets	
Included Accessories	1x DisplayPort Cable; 1x Microphone Cable; 1x Speaker Cable; 1x USB Type-A to Type-B Cable; 2x Mounting Kits; 2x Power Adapters	

Optional Accessories

Type	Part No. / Spec.	Page No.
DisplayPort KVM Cables	2L-7D02DP (1.8 m) 2L-7D03DP (3 m) 2L-7D05DP (5 m)	12-3 U
HDBaseT Cat 6 Cable	2L-2910	5-23

CE820

USB HDMI HDBaseT 2.0 KVM Extender

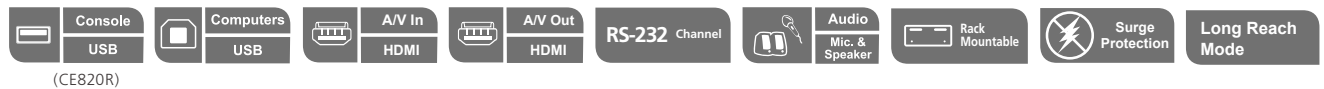

(CE820R)

Front

- CE820L



- CE820R



Rear

- CE820L



- CE820R



Features

- [Supports HDBaseT 2.0 technology](#)
 - Extends video, audio, USB, RS-232, and Ethernet signals via a single Cat6 / 6a / ATEN 2L-2910 Cat 6 cable
 - Enhanced bit error detection and correction to resist signal interference during high-quality video transmissions
 - Status detection and LED indication for HDBaseT signal transmission on remote unit
- EDID Buffer for smooth power-up and the highest quality display
- HDMI (3D, Deep Color, 1080P, 4K); HDCP 2.2 Compatible
- [Long distance with superior video quality](#)
 - HDBaseT Standard mode up to 4K @ 100 m (Cat 6 / 6a / 2L-2910)
 - HDBaseT Long-Reach mode up to 1080P @ 150 m
- Long Reach mode switch – switches between HDBaseT Standard and Long Reach modes in a snap
- USB 2.0 full speed ports – ensures fast transmission speeds for peripherals
- Supports individual 2-channel stereo audio for high-quality audio applications
- Supports PC wakeup function via single pushbutton
- Built-in 8KV / 15KV ESD protection (Contact voltage 8KV; Air voltage 15KV)

Specifications

Function	CE820L	CE820R
Connectors		
Console Ports	N/A	1 x HDMI Female (Black) 3 x USB Type A Female 1 x Mini Stereo Jack Female (Green) 1 x Mini Stereo Jack Female (Pink) 1 x RJ-45 Female (Black)
KVM Ports	1 x HDMI Female (Black) 1 x USB Type B Female (White) 1 x Mini Stereo Jack Female (Green) 1 x Mini Stereo Jack Female (Pink) 1 x RJ-45 Female (Black)	N/A
RS-232	1 x DB-9 Female (Black)	1 x DB-9 Male (Black)
Power	1 x DC Jack with locking	
Unit To Unit	1 x RJ-45 Female (Black)	
LEDs		
Power	1 (Green)	
Link	1 (Orange)	
Video Output	N/A	1 (Orange)
Video	Up to 4K@90 m (Cat 5e) / 100 m (Cat 6 / 6a / ATEN 2L-2910 Cat 6), 1080P @ 100 m (Cat 5e / 6 / 6a) *4K supported: 4096 x 2160 / 3840 x 2160 @ 60Hz (4:2:0); 4096 x 2160 / 3840 x 2160 @ 30Hz (4:4:4)	
Power Consumption	DC5V: 2.87W	DC5V: 5.37W
Environmental		
Operating Temperature	0–40°C	
Storage Temperature	-20–60°C	
Humidity	0–80% RH, Non-condensing	
Physical Properties		
Housing	Metal	
Weight	0.63 kg (1.39 lb)	0.65 kg (1.43 lb)
Dimensions (L x W x H)	18.20 x 12.19 x 2.87 cm (7.17 x 4.80 x 1.13 in.)	
Carton Lot	5 sets	
Included Accessories	1x HDMI KVM Cable Set; 2x Power Adapters; 2x Mounting Kits	

Optional Accessories

Type	Part No. / Spec.	Page No.
HDMI KVM Cable	2L-7D02UH (1.8 m)	12-3 T
HDBaseT Cat 6 Cable	2L-2910	5-23

CE624

USB DVI Dual View HDBaseT 2.0 KVM Extender

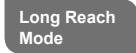

Console
USB

Computers
USB

DVI-D

Resolution
1920 x 1200

RS-232 Channel

Dual View

Audio
Mic. & Speaker

Rack Mountable

Surge Protection

(CE624R)

Front

- CE624L



- CE624R



Rear

- CE624L



- CE624R



Features

- Allows **DVI Dual-view** access and KVM control to a computer from a remote console
- **Supports HDBaseT 2.0 technology**
 - Extends video, audio, USB, RS-232, and Ethernet signals via a single Cat6 / 6a / ATEN 2L-2910 Cat 6 cable
 - Enhanced bit error detection and correction to resist signal interference during high-quality video transmissions
 - Status detection and LED indication for HDBaseT signal transmission on remote unit
- EDID Buffer for smooth power-up and the highest quality display
- **Long distance with superior video quality**
 - HDBaseT Standard mode up to 1920 x 1200 @ 100 m using Cat 6 / 6a / 2L-2910 (for single view only; dual-view resolution up to 1080p)
 - HDBaseT Long-Reach mode up to 1080p @ 150 m (for single view only; dual-view resolution up to 720p)
- Long Reach mode switch – switches between HDBaseT Standard and Long Reach modes in a snap
- USB 2.0 full speed ports – ensures fast transmission speeds for peripherals
- Supports 2-channel PCM digital audio – ensuring high quality audio applications
- Supports PC wakeup function via pushbutton or hotkey
- Built-in 8KV / 15KV ESD protection (Contact voltage 8KV; Air voltage 15KV)
- HDCP compatible

Specifications

Function	CE624L	CE624R
Connectors		
Console Ports	N/A	2 x DVI-D Female (White) 3 x USB Type A Female (White) 1 x Mini Stereo Jack Female (Green) 1 x Mini Stereo Jack Female (Pink)
KVM Ports	2 x DVI-D Female (White) 1 x USB Type B Female (White) 1 x Mini Stereo Jack Female (Green) 1 x Mini Stereo Jack Female (Pink)	N/A
RS-232	1 x DB-9 Female (Black)	1 x DB-9 Male (Black)
Power	1 x DC Jack with locking	
Unit To Unit	1 x RJ-45 Female (Black)	
LEDs		
Power	1 (Green)	
Link	1 (Orange)	
Video Output	N/A	2 (Orange)
Video	Up to 1600 x 1200 & 1920 x 1200 @ 90 m (Cat 5e) / 100 m (Cat 6 / 6a / ATEN 2L-2910 Cat 6), 1080P @ 100 m	
Power Consumption	DC5V: 4.93W	DC5V: 7.2W
Environmental		
Operating Temperature	0–40°C	
Storage Temperature	-20–60°C	
Humidity	0–80% RH, Non-condensing	
Physical Properties		
Housing	Metal	
Weight	0.80 kg (1.78 lb)	0.81 kg (1.76 lb)
Dimensions (L x W x H)	17.42 x 15.94 x 2.88 cm (6.86 x 6.28 x 1.13 in.)	
Carton Lot	1 set	
Included Accessories	2x DVI-D Cables; 2x Audio Cables; 1x USB Cable; 2x Power Adapters; 8x Food Pads; 2x Mounting Kits	

Optional Accessories

Type	Part No. / Spec.	Page No.
USB DVI-D Single Link KVM Cables	2L-7D02U (1.8 m), 2L-7D03U (3 m), 2L-7D05U (5 m)	12-3 O
HDBaseT Cat 6 Cable	2L-2910	5-23

CE620

USB DVI HDBaseT 2.0 KVM Extender

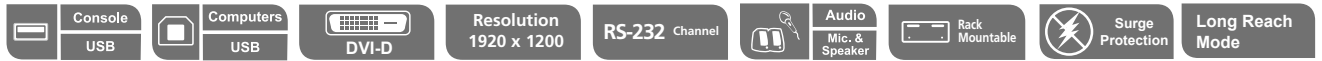

(CE620R)

Front

- CE620L



- CE620R

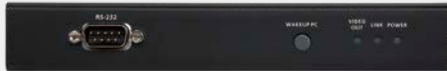

Rear

- CE620L



- CE620R



Features

- **Supports HDBaseT 2.0 technology**
 - Extends video, audio, USB, RS-232, and Ethernet signals via a single Cat6 / 6a / ATEN 2L-2910 Cat 6 cable
 - Enhanced bit error detection and correction to resist signal interference during high-quality video transmissions
 - Status detection and LED indication for HDBaseT signal transmission on remote unit
- EDID Buffer for smooth power-up and the highest quality display
- **Long distance with superior video quality**
 - HDBaseT Standard mode up to 1920 x 1200 @ 100 m (Cat 6 / 6a / 2L-2910)
 - HDBaseT Long-Reach mode up to 1080p @ 150 m
- Long Reach mode switch – switches between HDBaseT Standard and Long Reach modes in a snap
- USB 2.0 full speed ports – ensures fast transmission speeds for peripherals
- Supports 2-channel PCM digital audio – ensuring high quality audio applications
- Supports PC wakeup function via pushbutton or hotkey
- Built-in 8KV / 15KV ESD protection (Contact voltage 8KV; Air voltage 15KV)

Specifications

Function	CE620L	CE620R
Connectors		
Console Ports	N/A	1 x DVI-D Female (White) 3 x USB Type A Female 1 x Mini Stereo Jack Female (Green) 1 x Mini Stereo Jack Female (Pink)
KVM Ports	1 x DVI-D Female (White) 1 x USB Type B Female (White) 1 x Mini Stereo Jack Female (Green) 1 x Mini Stereo Jack Female (Pink)	N/A
RS-232	1 x DB-9 Female (Black)	1 x DB-9 Male (Black)
Power	1 x DC Jack with locking	
Unit To Unit	1 x RJ-45 Female (Black)	
LEDs		
Power	1 (Green)	
Link	1 (Orange)	
Video Output	N/A	1 (Orange)
Video	Up to 1600 x 1200 & 1920 x 1200 @ 90 m (Cat 5e) / 100 m (Cat 6 / 6a / ATEN 2L-2910 Cat 6), 1080P @ 100 m	
Power Consumption	DC5V: 2.68W	DC5V: 5.02W
Environmental		
Operating Temperature	0–40°C	
Storage Temperature	-20–60°C	
Humidity	0–80% RH, Non-condensing	
Physical Properties		
Housing	Metal	
Weight	0.63 kg (1.39 lb)	0.64 kg (1.41 lb)
Dimensions (L x W x H)	18.20 x 12.28 x 2.87 cm (7.17 x 4.83 x 1.13 in.)	
Carton Lot	5 sets	
Included Accessories	1x Custom KVM Cable; 2x Power Adapters; 2x Mounting Kits	

Note: CE620 does not support HDCP.

Optional Accessories

Type	Part No. / Spec.	Page No.
USB DVI-D Single Link KVM Cables	2L-7D02U (1.8 m), 2L-7D03U (3 m), 2L-7D05U (5 m)	12-3 O
HDBaseT Cat 6 Cable	2L-2910	5-23

CE611

Mini USB DVI HDBaseT KVM Extender



(CE611R)

Front

• CE611L



• CE611R



Rear

• CE611L



• CE611R



Features

- Supports HDBaseT technology
 - Extends video, audio, USB, and RS-232 signals via a single Cat6 / 6a / ATEN 2L-2910 Cat 6 cable
 - Enhanced bit error detection and correction to resist signal interference during high-quality video transmissions
 - Status detection and LED indication for HDBaseT signal transmission on remote unit
- EDID Buffer for smooth power-up and the highest quality display
- Long distance with superior video quality – up to 1920 x 1200 @ 100 m (Cat 6 / 6a / ATEN 2L-2910 Cat 6)
- USB 2.0 full speed ports – ensures fast transmission speeds for peripherals
- Supports individual 2-channel stereo audio for high-quality audio applications
- Built-in 8KV / 15KV ESD protection (Contact voltage 8KV; Air voltage 15KV)

Specifications

Function	CE611L	CE611R
Connectors		
Console Ports	N/A	1 x DVI-D Female (White) 2 x USB Type A Female 1 x Mini Stereo Jack Female (Green) 1 x Mini Stereo Jack Female (Pink)
KVM Ports	1 x DVI-D Female (White) 1 x USB Type B Female (White) 1 x Mini Stereo Jack Female (Green) 1 x Mini Stereo Jack Female (Pink)	N/A
RS-232	1 x DB-9 Female (Black)	1 x DB-9 Male (Black)
Power	1 x DC Jack with locking	
Unit To Unit	1 x RJ-45 Female (Silver)	
LEDs		
Power	1 (Green)	
Link	1 (Orange)	
Video Output	N/A	1 (Orange)
Video	Up to 1600 x 1200 & 1920 x 1200 @ 90 m (Cat 5e) / 100 m (Cat 6 / 6a / ATEN 2L-2910 Cat 6); 1080P @ 100 m	
Power Consumption	DC5V: 2.494W	DC5V: 4.816W
Environmental		
Operating Temperature	0–40°C	
Storage Temperature	-20–60°C	
Humidity	0–80% RH, Non-condensing	
Physical Properties		
Housing	Metal	
Weight	0.35 kg (0.77 lb)	0.34 kg (0.75 lb)
Dimensions (L x W x H)	12.80 x 8.69 x 2.50 cm (5.04 x 3.42 x 0.98 in.)	
Included Accessories	2x Power Adapters	

Note: CE611 does not support HDCP.

Optional Accessories

Type	Part No. / Spec.	Page No.
USB DVI-D Single Link KVM Cables	2L-7D02U (1.8 m), 2L-7D03U (3 m), 2L-7D05U (5 m)	12-3 O
HDBaseT Cat 6 Cable	2L-2910	5-23

CE610A

DVI HDBaseT KVM Extender with ExtremeUSB®



Front

- CE610AL / CE610AR



Rear

- CE610AL



- CE610AR



Features

- Supports HDBaseT connectivity technology
- Single Cat 5e cable extends KVM to a remote site
- Superior Video Quality – up to 1920 x 1200 @ 60Hz at 100 m
- Anti-jamming – resists signal interference during high-quality video transmissions using HDBaseT technology
- ExtremeUSB® – supports transparent USB 2.0 signals and true plug-and-play (no software or drivers required)
- USB 2.0 Support* – connects devices such as keyboard, mouse, flash drive, printer, touch panel, USB 1.1 web cameras and other USB devices which require moderate amounts of bandwidth
- Built-in 8KV / 15KV ESD protection (Contact voltage 8KV; Air voltage 15KV)

Note: * The CE610A supports a maximum combined USB transfer rate of 40 Mbps for attached USB devices.

Specifications

Function	CE610AL	CE610AR
Connectors		
Video In	1 x DVI-D Female (White)	N/A
Video Output	N/A	1 x DVI-D Female (White)
Power	1 x DC Jack	
Firmware Upgrade	1 x mini-USB	
USB Port	1 x USB Type B Female (White)	3 x USB Type A Female (White)
Unit To Unit	1 x RJ-45 Female (Black)	
LEDs		
Power	1 (Green)	
Link	1 (Green)	
USB	1 (Green)	
Video	1 (Green)	
USB	USB 2.0 (Transfer Rate: Up to 40 Mbps)	
Video	1920 x 1200 @ 100 m (Cat 6 / 6a / ATEN 2L-2910 Cat 6)	
Power Consumption	DC5V: 15W	
Environmental		
Operating Temperature	0–40°C	
Storage Temperature	-20–60°C	
Humidity	0–80% RH, Non-condensing	
Physical Properties		
Housing	Metal	
Weight	0.62 kg (1.37 lb)	
Dimensions (L x W x H)	18.20 x 11.79 x 2.87 cm (7.17 x 4.64 x 1.13 in.)	
Carton Lot	5 sets	
Included Accessories	1x Custom DVI KVM Cable; 1x USB Cable; 2x Power Adapters; 1x Mounting Kit	

Note: For the CE610AR, power consumption will be 13.25W when all 3 USB ports are being used.

Optional Accessories

Type	Part No. / Spec.	Page No.
USB DVI-D Single Link KVM Cables	2L-7D02U (1.8 m), 2L-7D03U (3 m), 2L-7D05U (5 m)	12-3 O
HDBaseT Cat 6 Cable	2L-2910	5-23

CE680 / CE690

USB DVI Optical KVM Extender

Extension
600 m
• CE680

Extension
20 km
• CE690



Front

- CE680L / CE690L



- CE680R / CE690R



Rear

- CE680L / CE690L



- CE680R / CE690R



Note: The optical fiber modules are color-coded with:

- CE680L: Blue
- CE680R: Yellow
- CE690L: Purple
- CE690R: White

Features

- Superior video quality up to 1920 x 1200 @ 60Hz (24-bit) – receives an excellent, crisp image on your screen over long distances (CE680: up to 600 m, CE690: up to 20 km)
- **Touchscreen support** – connects a generic touchscreen, including up to 10-point multi-touch devices, to accommodate highly interactive applications (no extra drivers needed)
- **Dual console operation** – control your system from both the local and remote USB keyboard, monitor, and mouse consoles
- **Single fiber optic cable allows access to a computer or KVM installation from local / remote consoles**
- HDCP compatible
- RS-232 serial port – connects to a serial terminal or serial devices, such as touch screens and barcode scanners (Baud Rate: 115200 bps)
- PC Wakeup support – uses a pushbutton on a Remote Unit to wake a PC at the local site via RS-232
- Audio Enabled – supports stereo speakers and microphone
- Rack-mountable

Note: CE680 supports OM3 multi-mode fiber.

Specifications

Function	CE680L / CE690L	CE680R / CE690R
Connectors		
Console Ports	3 x USB Type A Female (White) 1 x DVI-D Female (White) 1 x Mini Stereo Jack Female (Green) 1 x Mini Stereo Jack Female (Pink)	
KVM Ports	2 x USB Type B Female (White) 1 x DVI-D Female (White) 1 x Mini Stereo Jack Female (Green) 1 x Mini Stereo Jack Female (Pink)	N/A
RS-232	1 x DB-9 Female (Black)	1 x DB-9 Male (Black)
Power	1 x DC Jack (Black)	
Unit To Unit	1 x bi-directional SFP (LC)	
LEDs		
Local	1 (Green)	N/A
Remote	1 (Green)	
Link	1 (Green)	
Fiber Optics		
Operating Distance	CE680: 600 m with (SM) fiber; CE690: 20 km with (SM) fiber	
Wavelength	1310 / 1550 nm for SM	
Data Rate	Single fiber: 3.125G bps	
Power Consumption	DC5.3V: 6.46W	DC5.3V: 5.94W
Environmental		
Operating Temperature	0–50°C	
Storage Temperature	-20–60°C	
Humidity	0–80% RH, Non-condensing	
Physical Properties		
Housing	Metal	
Weight	CE680: 1.10 kg (2.42 lb); CE690: 1.12 kg (2.47 lb)	
Dimensions (L x W x H)	21.50 x 16.33 x 4.18 cm (8.46 x 6.43 x 1.65 in.)	
Carton Lot	1 set	
Included Accessories	1x Custom KVM Cable; 1x USB Cable; 2x Power Adapters; 1x Mounting Kit	

Note: Operating distance is approximate. These are typical maximum distance that may vary depending on factors such as fiber type, fiber bandwidth, connector splicing, losses, modal or chromatic dispersion, environmental factors, and kinks.

Optional Accessories

Type	Part No. / Spec.	Page No.
USB DVI-D Single Link KVM Cables	2L-7D02U (1.8 m), 2L-7D03U (3 m), 2L-7D05U (5 m)	12-3 O

CE604

USB DVI Dual View Cat 5 KVM Extender

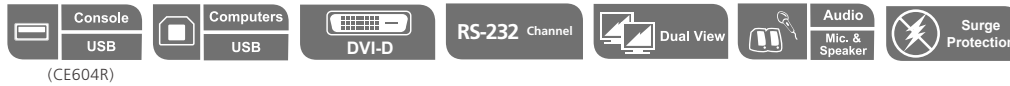

(CE604R)

Front

- CE604L



- CE604R



Rear

- CE604L



- CE604R



Features

- Transmit speaker, keyboard, mouse, DDC, and one DVI via one Cat 5 cable; RS-232, microphone, and another DVI by adding a second Cat 5e cable
- Supports **Dual-view** video source transmission (one PC with two video output ports)
- Audio Enabled – supports stereo speakers and microphone
- Supports Real DDC bypass and ATEN default EDID technology – set up various configurations via hotkeys
- Supports PC wakeup function via one pushbutton or hotkey
- RS-232 serial channel – connect to a serial terminal, or serial devices such as touchscreens and barcode scanners (Baud Rate up to 9600 bps)
- Compatible with other ATEN Dual-view KVM devices, such as CS1642A / CS1644A and CS1762A / CS1764A
- Superior video quality – up to 1920 x 1200 @ 60Hz at 30 m; 1024 x 768 @ 60Hz at 60 m
- Manual compensation control to adjust video signal quality in order to compensate for distance
- Built-in 8KV / 15KV ESD protection (Contact voltage 8KV; Air voltage 15KV) and 2KV surge protection

Specifications

Function	CE604L	CE604R
Connectors		
Console Ports	N/A	2 x USB Type A Female (White) 2 x DVI-D Female (White) 1 x Mini Stereo Jack Female (Green) 1 x Mini Stereo Jack Female (Pink)
KVM Ports	1 x USB Type B Female (White) 1 x Mini Stereo Jack Female (Green) 1 x Mini Stereo Jack Female (Pink) 2 x DVI-D Female (White)	N/A
RS-232	1 x DB-9 Female (Black)	1 x DB-9 Male (Black)
Power	1 x DC Jack (Black)	
Unit To Unit	2 x RJ-45 Female (Black)	
LEDs		
Link	1 (Green)	
Power	1 (Green)	
Video	1920 x 1200 @ 60Hz (30 m); 1024 x 768 @ 60Hz (60 m)	
Power Consumption	DC5.3V: 2.88W	DC5.3V: 2.35W
Environmental		
Operating Temperature	0–50°C	
Storage Temperature	-20–60°C	
Humidity	0–80% RH, Non-condensing	
Physical Properties		
Housing	Metal	
Weight	0.49 kg (1.08 lb)	
Dimensions (L x W x H)	20.20 x 8.53 x 2.50 cm (7.95 x 3.36 x 0.98 in.)	
Carton Lot	5 sets	
Included Accessories	1x Custom KVM Cable; 1x DVI Cable; 2x Power Adapters; 1x Mounting Kit	

Optional Accessories

Type	Part No. / Spec.	Page No.
USB DVI-D Single Link KVM Cables	2L-7D02U (1.8 m), 2L-7D03U (3 m), 2L-7D05U (5 m)	12-3 O
HDBaseT Cat 6 Cable	2L-2910	5-23
Low Skew Cable	2L-2801	5-25

CE600 / CE602

USB DVI Cat 5 KVM Extender / USB DVI Dual Link Cat 5 KVM Extender



(CE600R / CE602R)

(CE602)

Front

- CE600L / CE602L

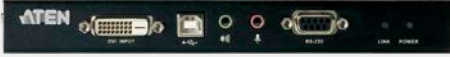

- CE600R / CE602R



Rear

- CE600L / CE602L

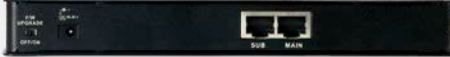

- CE600R / CE602R



Features

- Features ATEN technology that allows AV transmission over one cat 5e cable
- Allows access to a computer or KVM installation from a remote console (up to 60 m)
- Superior Video Quality up to 2560 x 1600 @ 60Hz at 40 m (DVI dual link; CE602)¹; 1920 x 1200 @ 60 Hz at 30 m (CE600); 1024 x 768 @ 60 Hz at 60 m – get an excellent, crisp image on your screen over long distance transmissions
- The 2nd Cat 5e cable is used for HDCP, RS-232, microphone, and dual link (CE602 only) signals
- Manual compensation control to adjust signal strength in order to compensate for distance
- RS-232 serial ports – connect to a serial terminal, or serial devices such as touchscreens and barcode scanners (Baud Rate up to 115200 bps)
- Audio Enabled – supports stereo speakers and microphone
- Built-in 8KV /15KV ESD protection (Contact voltage 8KV; Air voltage 15KV)
- Rack mountable
- Firmware upgradable

Note: 1. DVI dual link uses two Cat 5e cables to transmit 2560 x 1600 @ 60Hz. When the data rate on each cable is less than 1920 x 1200 @ 60Hz, the transmission distance becomes longer. The length of the 2 Cat 5e cables needs to be the same when transmitting dual link signals.

Specifications

Function	CE600L / CE602L	CE600R / CE602R
Connectors		
Console Ports	N/A	2 x USB Type A Female (White) 1 x DVI-D Female (White) 1 x Mini Stereo Jack Female (Green) 1 x Mini Stereo Jack Female (Pink)
KVM Ports	1 x DVI-D Female (White) 1 x Mini Stereo Jack Female (Green) 1 x Mini Stereo Jack Female (Pink) 1 x USB Type B Female (White)	N/A
RS-232	1 x DB-9 Female (Black)	1 x DB-9 Male (Black)
Power	1 x DC Jack	
Sub / Main	2 x RJ-45 Female (Black)	
LEDs		
Link	1 (Green)	
Power	1 (Green)	
Emulation		
Keyboard / Mouse	USB	
Video	2560 x 1600 @ 60Hz (40 m, Dual Link; CE602); 1024 x 768 @ 60Hz (60 m); 1920 x 1200 @ 60Hz (30 m; CE600)	
Power Consumption	CE600L: DC5.3V: 1.92W CE602L: DC5.3V: 2.68W	CE600R: DC5.3V: 1.69W CE602R: DC5.3V: 5.02W
Environmental		
Operating Temperature	0–50°C	
Storage Temperature	-20–60°C	
Humidity	0–80% RH, Non-condensing	
Physical Properties		
Housing	Metal	
Weight	0.48 kg (1.06 lb)	
Dimensions (L x W x H)	20.20 x 8.54 x 2.50 cm (7.95 x 3.36 x 0.98 in.)	CE600R: 20.20 x 8.50 x 2.50 cm (7.95 x 3.35 x 0.98 in.) CE602R: 20.20 x 8.68 x 2.50 cm (7.95 x 3.42 x 0.98 in.)
Carton Lot	5 sets	
Included Accessories	1x Custom KVM Cable; 2x Power Adapters; 1x Mounting Kit	

Optional Accessories

Type	Part No. / Spec.	Page No.
USB DVI-D Dual Link KVM Cables	CE602: 2L-7D02UD (1.8 m), 2L-7D03UD (3 m), 2L-7D05UD (5 m)	12-3 P
USB DVI-D Single Link KVM Cables	CE600: 2L-7D02U (1.8 m), 2L-7D03U (3 m), 2L-7D05U (5 m)	12-3 O
HDBaseT Cat 6 Cable	2L-2910	5-23
Low Skew Cable	2L-2801	5-25

CE800B

USB VGA / Audio Cat 5 KVM Extender

Extension
250 m



(CE800BL)

Front

- CE800BL



- CE800BR



Rear

- CE800BL / CE800BR



Features

- Uses a single Cat 5e cable to connect the local and remote units up to 250 m (825 ft)
- **Dual console operation** – control your system(s) from both the local and remote consoles
- **Gain Control** – automatically or manually adjust signal strength to compensate for distance
- Pushbutton selection of the active console
- Built-in USB port for external USB storage compliant flash drives for easy file sharing
- Special security feature requires login when attaching an external USB storage device on the remote unit
- Supports VGA, SVGA, and Multisync monitors; local monitor supports DDC, DDC2, and DDC2B
- Superior video quality – up to 1600 x 1200 @ 60Hz
- Built-in 8KV / 15KV ESD protection and 2KV surge protection
- Supports stereo speakers and stereo microphone
- Supports Microsoft Intellimouse and the scrolling wheel on most mice
- Built-in ASIC for greater reliability and compatibility
- Firmware upgradable

Specifications

Function	CE800BL	CE800BR
Computer Connections	1	N/A
Connectors		
Console Ports	2 x USB Type A Female (White), 1 x HDB-15 Female (Blue) 1 x Mini Stereo Jack (Green), 1 x Mini Stereo Jack (Pink)	
KVM Ports	1 x SPHD-15 Female (Yellow) 1 x USB Type B (Female) 1 x USB Type A (Female) 1 x Mini Stereo Jack (Green) 1 x Mini Stereo Jack (Pink)	1 x USB Type A (Female)
Firmware Upgrade	1 x 4-conductor 3.5 mm Jack	N/A
Power	1 x DC Jack	
Unit To Unit	1 x RJ-45	
LEDs		
Local	1 (Green)	N/A
Remote	1 (Green)	
Link	N/A	1 (Green)
Compensation	N/A	1 (Orange)
Video	1920 x 1200 @ 60Hz at 30 m; 1600 x 1200 @ 60Hz at 150 m; 1024 x 768 @ 60Hz at 250 m	
Power Consumption	DC5V: 2.67W	DC5V: 4.75W
Environmental		
Operating Temperature	0–50°C	
Storage Temperature	-20–60°C	
Humidity	0–80% RH, Non-condensing	
Physical Properties		
Housing	Metal	
Weight	0.51 kg (1.12 lb)	0.49 kg (1.08 lb)
Dimensions (L x W x H)	20.20 x 8.63 x 2.63 cm (7.95 x 3.4 x 1.04 in.)	20.20 x 8.16 x 2.63 cm (7.95 x 3.21 x 1.04 in.)
Carton Lot	5 sets	
Included Accessories	1x Custom KVM Cable; 1x USB Cable; 1x Firmware Upgrade Cable; 2x Power Adapters; 1x Mounting Kit	

Optional Accessories

Type	Part No. / Spec.	Page No.
USB KVM Cables	2L-5301U (1.2 m), 2L-5302U (1.8 m), 2L-5303U (3 m), 2L-5305U (5 m)	12-2 L
	HDBaseT Cat 6 Cable	2L-2910
	Low Skew Cable	2L-2801

CE774 / CE775

USB VGA Dual View Cat 5 KVM Extender /
 USB VGA Dual View Cat 5 KVM Extender with Deskew

Extension
150 m
• CE774

Extension
300 m
• CE775

Console USB
Computers SPHD USB
RS-232 Channel
ATEN Deskew (CE775R)
OSD Receiver (CE775R)
Audio Mic. & Speaker
Dual View
Surge Protection

Front

- CE774L



- CE774R



Rear

- CE774L / CE775L



- CE774R / CE775R



Features

- Uses two Cat 5e / 6 cables to connect the local and remote units up to 150 m / 300 m
- **Deskew Function** – automatically synchronizes the time delay of RGB signals to compensate for distance (CE775)
- **PC wake up support** – simply use a pushbutton to wake a computer at the local site via RS-232
- **Gain Control** – automatically or manually adjust signal strength to compensate for distance
- On Screen Display (OSD) – conveniently configure your CE775R with the intuitive OSD menu system
- **Auto Signal Compensation (ASC)**
- Supports keyboard combinations via emulation (for Sun / Mac)
- **Dual console operation** – control your system from both the local and remote USB keyboard, monitor and mouse consoles
- RS-232 serial ports – allow you to connect to a serial terminal, or serial devices such as touch screens and barcode scanners
- Superior Audio – no loss in audio quality at 150 m / 300 m
- Built-in 8KV / 15KV ESD protection (Contact voltage 8KV; Air voltage 15KV) and 2KV surge protection

Specifications

Function	CE774L / CE775L	CE774R / CE775R
Connectors		
Console Ports	2 x USB Type A Female (White), 2 x HDB-15 Female (Blue), 1 x Mini Stereo Jack Female (Green), 1 x Mini Stereo Jack Female (Pink)	
KVM Ports	1 x SPHD-17 Female (Yellow) 1 x Mini Stereo Jack (Green) 1 x Mini Stereo Jack (Pink) 1 x HDB-15 Male (Blue)	N/A
RS-232	1 x DB-9 Female (Black)	1 x DB-9 Male (Black)
Power	1 x DC Jack (Black)	
Unit To Unit	2 x RJ-45 Female (Black)	
LEDs		
Local	1 (Green)	N/A
Remote	1 (Green)	
Link	N/A	1 (Green)
Emulation		
Keyboard / Mouse	USB	
Video	CE774: 1920 x 1200 @ 60Hz (30 m); 1600 x 1200 @ 60Hz (150 m) CE775: 1600 x 1200 @ 60Hz (150 m); 1280 x 1024 @ 60Hz (300 m)	
Power Consumption	CE774L: DC5.3V: 3.83W CE775L: DC5.3V: 3.9W	CE774R: DC5.3V: 5.73W CE775R: DC5.3V: 8.6W
Environmental		
Operating Temperature	0–50°C	
Storage Temperature	-20–60°C	
Humidity	0–80% RH, Non-condensing	
Physical Properties		
Housing	Metal	
Weight	0.69 kg (1.52 lb)	
Dimensions (L x W x H)	20.00 x 7.62 x 4.20 cm (7.87 x 3 x 1.65 in.)	20.00 x 7.63 x 4.20 cm (7.87 x 3 x 1.65 in.)
Carton Lot	5 sets	
Included Accessories	1x Custom KVM Cable; 1x VGA Cable; 2x Power Adapters; 1x Mounting Kit	

Optional Accessories

Type	Part No. / Spec.	Page No.
USB KVM Cables	2L-5301U (1.2 m), 2L-5302U (1.8 m), 2L-5303U (3 m), 2L-5305U (5 m)	12-2 L
HDBaseT Cat 6 Cable	2L-2910	5-23
Low Skew Cable	2L-2801	5-25

CE770

USB VGA/Audio Cat 5 KVM Extender

With Deskew Functionality



Front

- CE770L



- CE770RQ



Rear

- CE770L / CE770RQ



Features

- Uses a single Cat 5e cable to connect the local and remote units up to 300 m
- **Deskew Function** – automatically synchronizes the time delay of RGB signals to compensate for distance
- **Gain Control** – automatically or manually adjust signal strength to compensate for distance
- **Auto Signal Compensation (ASC)**
- Supports keyboard combinations via emulation (for Sun / Mac)
- **Dual console operation** – control your system from both the local and remote USB keyboard, monitor and mouse consoles
- Supports VGA, SVGA, SXGA, UXGA, WUXGA, and Multisync monitors; local monitor supports DDC, DDC2, and DDC2B
- RS-232 serial ports – allows you to connect to serial terminals or devices, such as touchscreens and barcode scanners
- Audio Enabled – supports stereo speakers and microphone
- Built-in 8KV / 15KV ESD protection (Contact voltage 8KV; Air voltage 15KV) and 2KV surge protection
- Firmware upgradable
- Rack mountable

Specifications

Function	CE770L	CE770RQ
Connectors		
Console Ports	2 x USB Type A Female (White), 1 x HDB-15 Female (Blue), 1 x Mini Stereo Jack Female (Green), 1 x Mini Stereo Jack Female (Pink)	
KVM Ports	1 x SPHD-17 Female (Yellow), 1 x Mini Stereo Jack Female (Green), 1 x Mini Stereo Jack Female (Pink)	N/A
RS-232	1 x DB-9 Female (Black)	1 x DB-9 Male (Black)
Power	1 x DC Jack (Black)	
Unit To Unit	1 x RJ-45 Female (Black)	
LEDs		
Local	1 (Green)	N/A
Remote	1 (Green)	N/A
B	N/A	1 (Blue)
G	N/A	1 (Orange / Green)
R	N/A	1 (Red)
Emulation		
Keyboard / Mouse	USB	
Video	1920 x 1200 @ 60Hz (150 m); 1280 x 1024 @ 60Hz (300 m); DDC, DDC2, DDC2B	
Power Consumption	DC5.3V: 2.74W	DC5.3V: 4.54W
Environmental		
Operating Temperature	0–50°C	
Storage Temperature	-20–60°C	
Humidity	0–80% RH, Non-condensing	
Physical Properties		
Housing	Metal	
Weight	0.49 kg (1.08 lb)	
Dimensions (L x W x H)	20.20 x 8.64 x 2.50 cm (7.95 x 3.4 x 0.98 in.)	
Carton Lot	5 sets	
Included Accessories	1x Custom KVM Cable; 2x Power Adapters; 1x Mounting Kit	

Optional Accessories

Type	Part No. / Spec.	Page No.
USB KVM Cables	2L-5301U (1.2 m), 2L-5302U (1.8 m), 2L-5303U (3 m), 2L-5305U (5 m)	12-2 L
HDBaseT Cat 6 Cable	2L-2910	5-23
Low Skew Cable	2L-2801	5-25

CE750A

USB VGA/Audio Cat 5 KVM Extender

Extension
200 m



Front

- CE750AL



- CE750AR



Rear

- CE750AL / CE750AR



Features

- Uses a single Cat 5e cable to connect the local and remote units up to 200 m
- **Gain Control** – automatically or manually adjust signal strength to compensate for distance
- **Auto Signal Compensation (ASC)**
- **Dual console operation** – control your system from both the local and remote USB keyboard, monitor and mouse consoles
- Superior video quality – up to 1920 x 1200 @ 60Hz at 30 m, 1600 x 1200 @ 60Hz at 150 m, and 1280 x 1024 @ 60Hz at 200 m
- Supports VGA, SVGA, SXGA, UXGA, and Multisync monitors; local monitor supports DDC, DDC2, and DDC2B
- Supports stereo speakers and stereo microphone
- RS-232 serial ports – allow you to connect to a serial terminal for configuration (Local Unit) or serial devices such as touchscreens and barcode scanners
- Built-in 8KV / 15KV ESD protection (contact voltage 8KV, air voltage 15KV) and 2KV surge protection
- Firmware upgradable
- Rack mountable

Specifications

Function	CE750AL	CE750AR
Connectors		
Console Ports	2 x USB Type A Female (White) 1 x HDB-15 Female (Blue) 1 x Mini Stereo Jack Female (Green) 1 x Mini Stereo Jack Female (Pink)	
KVM Ports	1 x SPHD-15 Female (Yellow) 1 x Mini Stereo Jack Female (Green) 1 x Mini Stereo Jack Female (Pink)	N/A
RS-232	1 x DB-9 Female (Black)	1 x DB-9 Male (Black)
Power	1 x DC Jack (Black)	
Unit To Unit	1 x RJ-45 Female (Black)	
LEDs		
Remote	1 (Green)	
Link	N/A	1 (Green)
Local	1 (Green)	N/A
Picture Compensation	N/A	1 (Orange)
Emulation		
Keyboard / Mouse	USB	
Video	1920 x 1200 @ 60Hz at 30 m; 1600 x 1200 @ 60Hz at 150 m; 1280 x 1024 @ 60Hz at 200 m	
Power Consumption	DC5.3V: 2.44W	DC5.3V: 3.27W
Environmental		
Operating Temperature	0–50°C	
Storage Temperature	-20–60°C	
Humidity	0–80% RH, Non-condensing	
Physical Properties		
Housing	Metal	
Weight	0.47 kg (1.04 lb)	
Dimensions (L x W x H)	20.20 x 8.63 x 2.50 cm (7.95 x 3.4 x 0.98 in.)	20.20 x 8.51 x 2.50 cm (7.95 x 3.35 x 0.98 in.)
Carton Lot	5 sets	
Included Accessories	1x Custom KVM Cable; 2x Power Adapters; 1x Mounting Kit	

Optional Accessories

Type	Part No. / Spec.	Page No.
USB KVM Cables	2L-5301U (1.2 m), 2L-5302U (1.8 m), 2L-5303U (3 m), 2L-5305U (5 m)	12-2 L
HDBaseT Cat 6 Cable	2L-2910	5-23
Low Skew Cable	2L-2801	5-25

CE700A

USB VGA Cat 5 KVM Extender



Front

- CE700AL



- CE700AR



Rear

- CE700AL / CE770AR



Features

- Uses a single Cat 5e cable to connect the local and remote units up to 150 m
- **Automatic Gain Control** – adjusts signal strength to compensate for distance
- **Auto Signal Compensation (ASC)**
- **Dual console operation** – control your system from both the local and remote USB keyboard, monitor, and mouse consoles
- Built-in ASIC for greater reliability and compatibility
- Supports VGA, SVGA, SXGA, UXGA, WUXGA, and Multisync monitors; local monitor supports DDC, DDC2, and DDC2B
- Built-in 8KV / 15KV ESD protection (Contact voltage 8KV; Air voltage 15KV) and 2KV surge protection
- Superior video quality – up to 1920 x 1200 @ 60Hz (30 m); 1600 x 1200 @ 60Hz (100 m); 1280 x 1024 @ 60Hz (150 m)
- Rack mountable
- Easy to install – no software required; connecting cables to the devices is all it takes

Specifications

Function	CE700AL	CE700AR
Connectors		
Console Ports	2 x USB Type A Female (White) 1 x HDB-15 Female (Blue)	
KVM Ports	1 x SPHD-17 Female (Green)	N/A
Power	1 x DC Jack (Black)	
Unit To Unit	1 x RJ-45 Female (Black)	
LEDs		
Local	1 (Green)	N/A
Remote	1 (Green)	
Link	N/A	1 (Green)
Emulation		
Keyboard / Mouse	USB	
Video		
	1920 x 1200 @ 60Hz (30 m) 1600 x 1200 @ 60Hz (100 m) 1280 x 1024 @ 60Hz (150 m)	
Power Consumption	DC5.3V: 2.17W	DC5.3V: 1.59W
Environmental		
Operating Temperature	0–50°C	
Storage Temperature	-20–60°C	
Humidity	0–80% RH, Non-condensing	
Physical Properties		
Housing	Metal	
Weight	0.33 kg (0.73 lb)	0.32 kg (0.7 lb)
Dimensions (L x W x H)	12.70 x 8.65 x 2.50 cm (5 x 3.41 x 0.98 in.)	12.70 x 8.14 x 2.50 cm (5 x 3.2 x 0.98 in.)
Carton Lot	5 sets	
Included Accessories	1x Custom KVM Cable; 2x Power Adapters; 1x Mounting Kit	

Optional Accessories

Type	Part No. / Spec.	Page No.
USB KVM Cables	2L-5201U (1.2 m), 2L-5202U (1.8 m), 2L-5203U (3 m), 2L-5205U (5 m)	12-2 N
HDBaseT Cat 6 Cable	2L-2910	5-23
Low Skew Cable	2L-2801	5-25

CE100

USB VGA Cat 5 Mini KVM Extender

Most Compact Solution for Remote Access



(CE100R)

Front

• CE100L



• CE100R



Rear

• CE100L / CE100R



Features

- Uses a single Cat 5e cable to connect the local and remote units up to 100 m
- Supports real-time DDC communication when remote display is unplugged and plugged
- Support manual compensation adjustment for better video quality
- Extends local PC VGA/keyboard/mouse to remote side
- Easily add or remove computers connected to the installation
- Superior video quality – up to 1920 x 1200
- Allow access to a computer from the remote console up to 100 m distance
- No external power supply needed for local unit
- Built-in 8KV / 15KV ESD protection (Contact voltage 8KV; Air voltage 15KV)
- Wall mountable

Specifications

Function	CE100L	CE100R
Connectors		
Console Ports	N/A	2 x USB Type A Female (White) 1 x HDB-15 Female (Blue)
KVM Ports	1 x USB Type B Female (White) 1 x HDB-15 Male (Blue)	N/A
Power	1 x DC Jack	
Unit To Unit	1 x RJ-45 Female (Black)	
LEDs		
Link	1 (Blue)	
Power	1 (Green)	
Video	1920 x 1200 @ 60 Hz (30 m); 1280 x 1024 @ 60 Hz (100 m)	
Power Consumption	DC5V: 0.68W	DC5V: 0.99W
Environmental		
Operating Temperature	0–50°C	
Storage Temperature	-20–60°C	
Humidity	0–80% RH, Non-condensing	
Physical Properties		
Housing	Metal	
Weight	0.17 kg (0.37 lb)	
Dimensions (L x W x H)	9.10 x 5.74 x 2.40 cm (3.58 x 2.26 x 0.94 in.)	
Carton Lot	20 sets	
Included Accessories	1x Custom KVM Cable; 1x Power Adapter; 1x Mounting Kit	

Optional Accessories

Type	Part No. / Spec.	Page No.
USB KVM Cable	2L-5001U (1.2 m)	12-2 K
HDBaseT Cat 6 Cable	2L-2910	5-23
Low Skew Cable	2L-2801	5-25

CE350 / CE370

PS/2 VGA/Audio Cat 5 KVM Extender

With Deskew Functionality (CE370)

Extension
150 m
• CE350

Extension
300 m
• CE370

Console
PS/2

Computers
SPHD
USB

ATEN
Deskew
(CE370)

RS-232 Channel

Audio
Mic. &
Speaker

Surge
Protection

Front

- CE350L / CE370L



- CE350R



- CE370RQ



Rear

- CE350L / CE350R
- CE370L / CE370RQ



Features

- Uses a single Cat 5e cable to connect the local and remote units up to 150 m (CE350) and 300 m (CE370)
- **Deskew Function (CE370)** – automatically synchronizes the time delay of RGB signals to compensate for distance
- **Gain Control** – automatically or manually adjust signal strength to compensate for distance
- **Auto Signal Compensation (ASC) and storage of settings**
- **Dual console operation** – control your system from both the local and remote keyboard, monitor, and mouse consoles
- Built-in ASIC for greater reliability and compatibility
- RS-232 serial ports – connect to a serial terminal, or serial devices such as touchscreens and barcode scanners (Baud Rate up to 115,200 bps)
- Audio Enabled – supports stereo speakers and microphone
- Built-in 8KV / 15KV ESD protection (Contact voltage 8KV; Air voltage 15KV) and 2KV surge protection
- Supports VGA, SVGA, SXGA, UXGA, WUXGA, and Multisync monitors; local monitor supports DDC, DDC2, and DDC2B
- Firmware upgradable
- Rack mountable

Specifications

Function	CE350L / CE370L	CE350R / CE370RQ
Connectors		
Console Ports	1 x 6-pin Mini-DIN Female (Purple) 1 x HDB-15 Female (Blue) 1 x 6-pin Mini-DIN Female (Green) 1 x Mini Stereo Jack Female (Green) 1 x Mini Stereo Jack Female (Pink)	
KVM Ports	1 x SPHD-17 Female (Yellow) 1 x Mini Stereo Jack (Green) 1 x Mini Stereo Jack (Pink)	N/A
RS-232	1 x DB-9 Female (Black)	1 x DB-9 Male (Black)
Power	1 x DC Jack	
Unit To Unit	1 x RJ-45 Female (Black)	
Emulation		
Keyboard / Mouse	PS/2	
Video	CE350: 1920 x 1200 @ 60Hz (30 m); 1600 x 1200 @ 60Hz (150 m); DDC, DDC2, DDC2B CE370: 1920 x 1200 @ 60Hz (150 m); 1280 x 1024 @ 60Hz (300 m); DDC, DDC2, DDC2B	
Power Consumption	CE350L: DC5.3V: 2.87W CE370L: DC5.3V: 2.70W	CE350R: DC5.3V: 4.85W CE370RQ: DC5.3V: 4.53W
Environmental		
Operating Temperature	0–50°C	
Storage Temperature	-20–60°C	
Humidity	0–80% RH, Non-condensing	
Physical Properties		
Housing	Metal	
Weight	0.50 kg (1.1 lb)	
Dimensions (L x W x H)	20.20 x 8.64 x 2.50 cm (7.95 x 3.4 x 0.98 in.)	
Carton Lot	5 sets	
Included Accessories	1x Custom KVM Cable; 2x Power Adapters; 1x Mounting Kit	

Optional Accessories

Type	Part No. / Spec.	Page No.
PS/2 KVM Cables	2L-5302P (1.8 m), 2L-5303P (3 m), 2L-5305P (5 m)	12-2 M
Cables & Converters for USB Interface Support*	PC compatible: 2L-5202UP (1.8 m), 2L-5203UP (3 m), 2L-5205UP (5 m), 2L-5206UP (6 m)	12-1 E
HDBaseT Cat 6 Cable	2L-2910	5-23
Low Skew Cable	2L-2801	5-25

CE250A

PS/2 VGA Cat 5 KVM Extender



Front

- CE250AL



- CE250AR



Rear

- CE250AL / CE250AR



Features

- Uses a single Cat 5e cable to connect the local and remote units up to 150 m
- **Automatic Gain Control** – adjusts signal strength to compensate for distance
- **Dual console operation** – control your system from both the local and remote PS/2 keyboard, mouse and monitor consoles
- Superior video quality – up to 1280 x 1024 @ 60Hz
- Supports VGA, SVGA, and Multisync monitors; local monitor supports DDC, DDC2, and DDC2B
- Supports Microsoft Intellimouse and the scrolling wheel on most mice
- Built-in 8KV ESD protection and 2KV surge protection
- Local unit takes its power from the computer - external power is only required when the power from the local computer / computers in the KVM installation is insufficient
- Rack-mountable

Specifications

Function	CE250AL	CE250AR
Console Selection	1 x Pushbutton	
Connectors		
Console Ports	1 x 6-pin Mini-DIN Female (Purple) 1 x HDB-15 Female (Blue) 1 x 6-pin Mini-DIN Female (Green)	
KVM Ports	1 x SPHD-15 Female	N/A
Power	1 x DC Jack	
Unit To Unit	1 x RJ-45 Female (Black)	
LEDs		
Local	1 (Green)	N/A
Remote	1 (Green)	N/A
Power	N/A	1 (Green)
Online	N/A	1 (Green)
Emulation		
Keyboard / Mouse	PS/2	
Video	1280 x 1024 @ 60Hz (150 m) DDC; DDC2; DDC2B	
Power Consumption	DC5V: 0.62W	DC5V: 1.21W
Environmental		
Operating Temperature	0–50°C	
Storage Temperature	-20–60°C	
Humidity	0–80% RH, Non-condensing	
Physical Properties		
Housing	Metal	
Weight	0.33 kg (0.73 lb)	0.32 kg (0.7 lb)
Dimensions (L x W x H)	12.70 x 8.66 x 2.63 cm (5 x 3.41 x 1.04 in.)	12.70 x 8.15 x 2.63 cm (5 x 3.21 x 1.04 in.)
Carton Lot	5 sets	
Included Accessories	1x Custom KVM Cable; 1x Power Adapter; 1x Mounting Kit	

Optional Accessories

Type	Part No. / Spec.	Page No.
PS/2 KVM Cables	2L-5201P (1.2 m), 2L-5202P / 2L-5702P (1.8 m), 2L-5203P (3 m), 2L-5206P (6 m)	12-1 C 12-1 D
Cables & Converters for USB Interface Support*	PC compatible: 2L-5202UP (1.8 m), 2L-5203UP (3 m), 2L-5205UP (5 m), 2L-5206UP (6 m)	12-1 E
HDBaseT Cat 6 Cable	2L-2910	5-23
Low Skew Cable	2L-2801	5-25



2L-2910

305M HDBaseT SF / UTP Cat 6 Cable



5

KVM Extenders

The 2L-2910 is a twisted pair cable engineered for optimum signal transmission at resolutions up to 4K including digital and analogue data, audio, and video applications. The cable supports sweep frequency up to 400 MHz and has been verified to meet performance requirements set by the HDBaseT Alliance.

The 2L-2910 supports long distance connections while safeguarding transmission quality. The outer metal layer and the braid protect signal transmissions from electromagnetic interference and reduce the impact caused by electrical noise.

The 2L-2910 utilizes SF/UTP design with four unshielded 23 AWG twisted pair conductors. Among the four unshielded twisted pair conductors, there is one cross filler to reduce cross talk. Most importantly, the cable meets the requirements set by ANSI/ TIA-568-C.2 (2009) ensuring high performance in electrical transmission.



Features

- Optimized for multiple distributions including HD video, audio, Ethernet, power and control
- Verified to meet performance requirements set by HDBaseT Alliance
- Supports sweep frequency up to 400 MHz
- Supports up to 4K data transmission
- Conductor material: 23 AWG bare copper
- Outer shielded material: Al Mylar tape
- Braid wire: tinned copper
- Flame test UL 1685 (CM rated), RoHS compliant
- Compatible with ATEN HDBaseT extenders and splitters
- Regulatory:
 - PoE: IEEE 802.3af (PoE)/ IEEE 802. 3at (PoE+)
 - Electrical Transmission: ANSI/TIA-568-C.2 (2009), ISO/IEC 11801 (Edition 2.2), IEC 61156-5 (Edition 2.1)
 - Material and Construction: UL 444, CSA 22.2 NO.214



2L-2910 Specifications

Function	2L-2910
Cable Type	Cat 6 SF/UTP
Conductor	
Size	23 AWG
Construction	Solid Bare copper
Number of Pairs	4
Insulation	
Material	Polyolefin
Color codes	Blue & White/Blue stripe 1.08 ± 0.02 mm; Orange & White/Orange stripe 1.05 ± 0.02 mm Green & White/Green stripe 1.08 ± 0.02 mm; Brown & White/Brown stripe 1.05 ± 0.02 mm
Shield	
Material	Al Mylar tape
Coverage	100% Coverage and mylar side facing out
Filler	Polyolefin (PO)
Braid	Tinned Copper
Electrical	
Dc Resistance Unbalance	≤ 5%
Conductor Resistance	≤ 9.38 Ω/100m
Dielectric strength	1.5 KV ac for 2 s
Insulation resistance	≥ 5000 MΩ•km
Mutual Capacitance	≤ 5.6 nF/100m
Pair-To-Ground Capacitance Unbalance	≤ 330 pF/100m
Ac Leakage Current Throught Overall Jacket	≤ 10mA (1.5KV AC)
Spark Test	2.5 KV DC
Minimum bending radius	≥4 times of overall diameter
Delay Skew	45.00 Max.ns/100m
Jacketed	
Average Thickness	0.5 mm±-0.05mm
Diameter	7.4 ± 0.20 mm
Material	Polyvinyl chloride (PVC)
Color	Blue
Environmental	
Temperature (Operating / Storage)	-20°C - 60°C
Physical Properties	
Weight	17.57 kg (38.7 lb)
Cable Length	305m / 1000ft

2L-2801

305M Low Skew Cat 5e Cable

5

KVM Extenders

Analog video presents a high quality image when the computer is directly connected to the monitor by short cables. "Skew" is the color phase and time errors that occur when R/G/B video signals are sent over long distance Cat 5e cables which can result in smeared, less sharp and color-fringed images. To remedy this distortion, ATEN developed a Low Skew Cat 5e cable. This high performance cable is suitable for the audio and video transmission of a wide range of video and KVM extenders. To eliminate blur and bleeding images and to ensure clear video transmissions, use 2L-2801 Low Skew Cat 5e Cable.



Features

- Supports high quality RGB video transmissions
- Contains 305 m (1000 ft.) low skew cable
- Delay Skew: 1 ~ 350 MHz 20nS/100 m Max.
- Outer jack material: FR PVC
- Outer material: unshielded
- Conductor material: 24 AWG solid bare copper
- Compatible with ATEN analog Cat 5 video extenders, KVM extenders and Cat 5 KVM switches
- UL, ETL approved

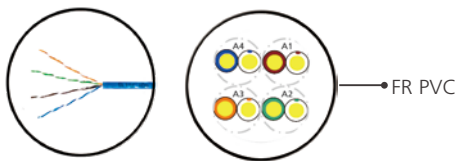



2L-2801 Specifications

Function	2L-2801
Item	24AWG × 4p
Cable Length	305 m/ 1000 ft
Conductor Resistance	9.38 Ohm/100m/20°C Max.
Mutual Capacitance	56 Pf/M Max.
Dielectric strength	Ac 1.5 Kv/2 Sec.
Spark Test	2.5 Kv
Insulation	
Unaged	Tensile Strength: 2400 Psi Min. (1.69 Kg/M(mxm))
Aged	Tensile Strength: Unaged Min. 75%(100°C×48hrs) Elongation: Unaged Min. 75%(100°C×48hrs)
Jacketed	
Unaged	Tensile Strength: 2000 Psi Min.(1.41 Kg/M(mxm)) Elongation: 100% Min.
Aged	Tensile Strength: Unaged Min. 85%(100°C×240hrs) Elongation: Unaged Min. 50%(100°C×240hrs)
Insulation Shrinkback	150m/M, 121°C±1°C×1hr ≤ 9.5m/M
Cold Bend Test	-20°C×4hrs No.Crack
Flame Retardant Test	CMR
Ac Leakage Current Through Overall Jacket	Ac 1500v ≤ 10 Ma
Dc Resistance Unbalance	5% Max.
Pair-To-Ground Capacitance Unbalance	330 Pf/100m Max.
Characteristic Impedance	1 - 350 Mhz 100±15 Ohms
Structural Return Loss	350 Mhz 10.6db Min.
Propagation Delay	350 Mhz 536ns/100m Max.
Delay Skew	1 - 350 Mhz 20ns/100m Max.
Physical Properties	
Weight	9.80 kg

Cable KVM Switches

6

Cable KVM Switches

ATEN's patented all-in-one design eliminates the clutter and bother of connecting separate keyboard, video and mouse cables by consolidating them into a single cable and building that cable right into the switch. The result is a smart-looking, neat and tidy work environment.

Cable KVM Switches are offered in PS/2, USB, and a combination of both PS/2 and USB configurations. Users can choose the switch that matches their hardware – even combining USB and PS/2 keyboards and mice.



- **Flexible Port Selection**

For flexibility and convenience there are three ways to switch ports: with hotkeys from the keyboard, mouse port switching, and by clicking with the remote port selector device. Hotkeys provide more control of the focus, while the remote selector device saves the bother of remembering the appropriate hotkey combinations. In addition, a quick and easy switching solution is to click the mouse's scroll wheel to cycle through the ports.

- **Audio Support**

The Cable KVM Switches are designed with microphone and speaker support, allowing audio input/output for multimedia applications that make use of sound.

- **Flexible Focus Assignment**

The KVM focus and audio focus can be switched independently of each other, which means that users can work on the computer with the KVM focus while listening to the output of the computer with the audio focus. Users can switch the KVM focus from port to port without moving the audio focus and vice versa.

- **Multifunction Mouse Support**

Many of the ATEN Cable KVM Switches support multifunction mice, allowing users to make full use of their mice across a broad spectrum of multimedia applications.

- **USB Peripheral Sharing**

A 2 or 4 port USB hub can be connected to the switch's mouse port, allowing USB peripherals to connect to the switch and be shared by all the computers on the installation.

- **Video DynaSync™**

ATEN's exclusive Video DynaSync™ technology automatically detects the horizontal and vertical offset values of each computer's display settings and synchronizes them with the monitor you are working on, ensuring that the display resolution will always be correct when switching ports.

Note: The features highlighted above are not available in all products. Please refer to each product page for more details.
Product information is subject to change without prior notice.

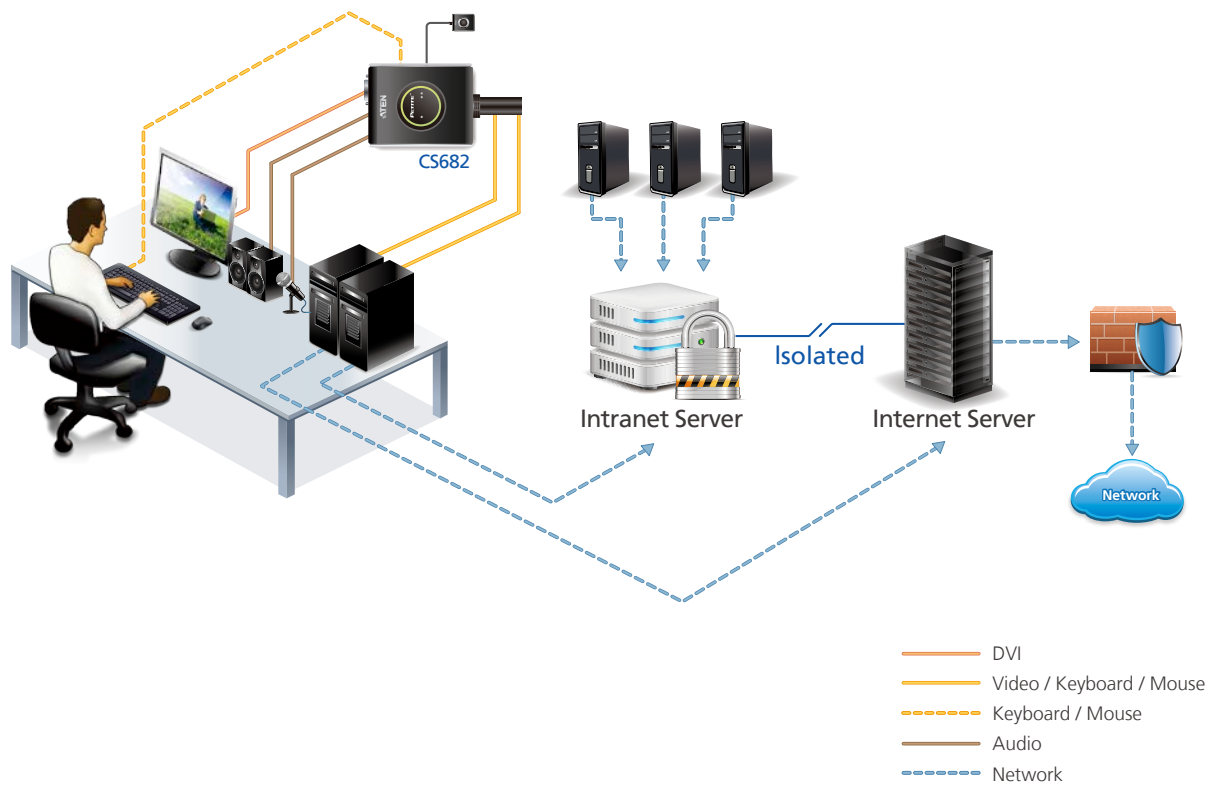
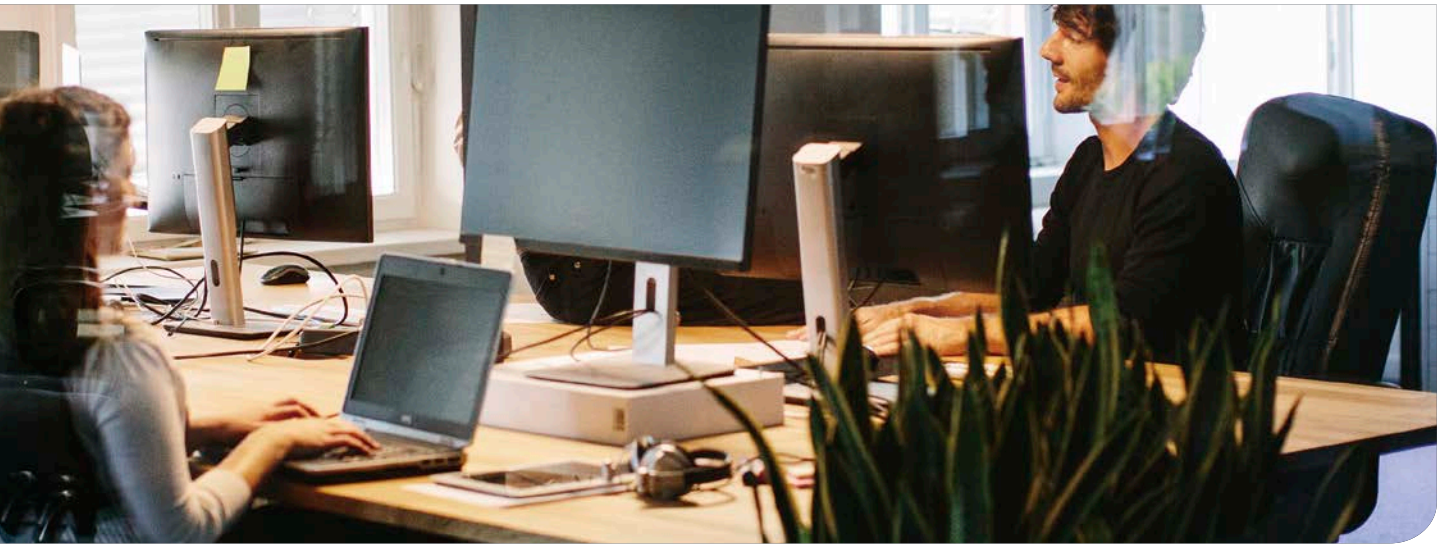

Feature Comparison

Model No.	CV211	CS22DP	CS692	CS682	CS22D
Ports	1	2	2	2	2
Interface	Keyboard, Mouse	USB	USB	USB	USB
	Video	VGA	DisplayPort	HDMI	DVI
Platform Support	Windows, Linux	Windows, Linux, Mac,	Windows, Linux, Mac	Windows, Linux, Mac, Sun	Windows, Linux, Mac, Sun
Audio	N/A	•	•	•	N/A
Cable Length	CV211 to laptop: 1.8 m CV211 to computer: 0.4 m	1.2 m	1.2 m	1.2 m	1.2 m
USB Peripheral Sharing	N/A	•	•	•	•
Video DynaSync™	N/A	N/A	•	•	N/A
Port Selection	N/A	Remote Port Selector	Hotkey, Remote Port Selector, Mouse	Hotkey, Remote Port Selector, Mouse	Remote Port Selector

Model No.	CS62U	CS62US	CS64U	CS64US	CS22U
Ports	2	2	4	4	2
Interface	Keyboard, Mouse	USB	USB	USB	USB
	Video	VGA	VGA	VGA	VGA
Platform Support	Windows, Linux, Mac, Sun	Windows, Linux, Mac, Sun	Windows, Linux, Mac, Sun	Windows, Linux, Mac, Sun	Windows, Linux, Mac, Sun
Audio	•	•	•	•	N/A
Cable Length	1.8 m	0.9 m	1.8 m	0.9 m, 1.2 m	0.9 m
USB Peripheral Sharing	•	•	•	•	•
Video DynaSync™	•	•	•	•	N/A
Port Selection	Hotkey, Mouse	Hotkey, Mouse	Hotkey	Hotkey	Remote Port Selector

Model No.	CS52A	CS52	CS62S	CS62A	CS64A
Ports	2	2	2	2	4
Interface	Keyboard, Mouse	PS/2, USB	PS/2, USB	PS/2	PS/2
	Video	VGA	VGA	VGA	VGA
Platform Support	Windows, Linux	Windows, Linux	Windows, Linux	Windows, Linux	Windows, Linux
Audio	•	N/A	N/A	•	•
Cable Length	0.6 m, 1.2 m	0.6 m, 1.2 m	0.9 m	1.2 m	1.8 m
USB Peripheral Sharing	•	•	N/A	N/A	N/A
Video DynaSync™	N/A	N/A	N/A	N/A	N/A
Port Selection	Hotkey, Remote Port Selector	Hotkey, Remote Port Selector	Hotkey	Hotkey	Hotkey

CV211

Laptop USB KVM Console Crash Cart Adapter



Specifications

Function	CV211
Computer Connections	1
Connectors	
Laptop USB Console (LUC) Port	1 x USB Mini-B Female
KVM (Computer) Ports	1 x USB Type A Male 1 x VGA Male (Blue)
LEDs	1 (Blue)
Power Consumption	DC5.0V: 2.35W
Environmental	
Operating Temperature	0–40°C
Storage Temperature	-20–60°C
Humidity	0–80% RH, Non-condensing
Physical Properties	
Housing	Plastic
Weight	0.13 kg (0.29 lb)
Dimensions (L x W x H)	7.05 x 5.37 x 3.01 cm (2.78 x 2.11 x 1.19 in.)
Carton Lot	10 pcs
Included Accessories	1x USB Type A to USB Mini-B Cable

Features

USB KVM Console Adapter Provides Direct Laptop-to-Computer Desktop Access

- Transforms your laptop into an ultra mobile console for servers, computers, kiosks and ATMs
- Virtual media enables file applications, OS patching, diagnostic testing and software installation
- Upgradable firmware to keep unit up to date
- Eliminates the need for heavy and bulky crash carts
- Desktop scaling – user can adjust the size/resolution of the target computer's desktop window by size or ratio

Server and Computer Troubleshooting

- Instant BIOS-level access gets you total control of a server during hardware and operating system failures
- Bi-directional file transfers between the laptop and target computer
- Video recording and image capture feature saves a record of remote operations for future training and troubleshooting
- Mouse DynaSync™ – automatically synchronizes the laptop and target computer's mouse movements
- On-screen keyboard with multi-language support
- Supports hotkey macros – define keystrokes that execute specific actions on the target computer to complete tasks efficiently and accurately

Ease of Use

- Plug-and-Play – no software installation required on either side
- Toolbar helps users easily operate all the functions from a single-click control panel within the remote view window
- Adjustable video settings for optimal picture and performance
- USB bus-powered design with hot-plugging support

Maximum Convenience

- Built-in VGA and USB keyboard/mouse cables
- Unique cable clip design to get cables under control
- Supports analog video resolutions up to 1920 x 1200 @ 60Hz
- Compact and easy to carry – half-palm size

Setup > CV211



CS22DP

2-Port USB DisplayPort Cable KVM Switch with Remote Port Selector

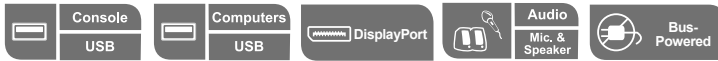

Features

- One USB keyboard / mouse and one DisplayPort monitor controls two USB DisplayPort computers
- Superior video quality – up to 4096 x 2160 @ 30Hz
- Computer selection via Remote Port Selector
- OS Support: Windows, Mac and Linux
- Supports DisplayPort Dual-Mode (DP++)¹ for directly outputting single-link HDMI and/or DVI signals via a DisplayPort-to-HDMI/DVI DP++ adapter
- Supports microphone and speakers
- The USB ports can be used for USB peripheral sharing²
- Supports USB hot-plugging
- HDCP Compatible
- Bus-powered – no external power adapter required

Note: 1. DisplayPort Dual-Mode (DP++) requires the use of a powered DP++ adapter. The graphics source must be DP++ compliant.

2. The CS22DP may require an external power supply via a micro USB port

Specifications

Function	CS22DP
Computer Connections	2
Connectors	
Console Ports	2 x USB Type A Female 1 x DisplayPort Female 1 x 3.5 mm Audio Jack Female (Green) 1 x 3.5 mm Audio Jack Female (Pink)
KVM (Computer) Ports	2 x USB Type A Male 2 x DisplayPort Male 2 x 3.5 mm Audio Jack Male (Green) 2 x 3.5 mm Audio Jack Male (Pink)
Power (Optional)	1 x USB Micro Type B Female
Port Selection	Remote Port Selector
Video	4096 x 2160 @ 30Hz
Cable Length	
Computer	2 x 1.2 m
Remote Port Selector	1.8 m
Emulation	
Keyboard / Mouse	N/A
LEDs	
Selected	2 (White)
Power Consumption	DC5V: 1.38W
Environmental	
Operating Temperature	0 - 50°C
Storage Temperature	-20 - 60°C
Humidity	0-80% RH, Non-condensing
Physical Properties	
Housing	Plastic
Weight	0.35 kg (0.77 lb)
Dimensions (L x W x H)	8.34 x 8.42 x 3.04 cm (3.28 x 3.31 x 1.2 in.)
Carton Lot	20 pcs

CS692

2-Port USB HDMI/Audio Cable KVM Switch with Remote Port Selector



Features

- USB 2.0 mouse port can be used as a USB hub and for USB peripheral sharing
- [Video DynaSync™ – exclusive ATEN technology eliminates boot-up display problems and optimizes the resolution when switching between ports](#)
- Independent switching of the KVM and audio focus – KVM is focused on one computer while the audio is focused on the other*
- Firmware upgradable
- One KVM console controls two USB HDMI computers
- HDCP compatible
- Audio-enabled – full bass response provides a rich experience for 2.1 channel surround sound systems
- Compact design, all-in-one cables (2 x 1.2 m) built-in
- Power on detection – if either of the computers is powered off, the CS692 will automatically switch to the other computer
- Compatible with widescreen LCD monitors
- Supports gaming and multimedia keyboards
- Supports multifunction and wireless keyboards and mice
- Supports keyboard combinations via emulation (for Mac)
- Bus-powered – no external power adapter required

Note: * HDMI audio through the HDMI monitor's built-in speakers cannot be switched independently

Specifications

Function	CS692
Computer Connections	2
Connectors	
Console Ports	1 x HDMI Female (Black), 2 x USB Type A Female, 1 x 3.5 mm Audio Jack Female (Green), 1 x 3.5 mm Audio Jack Female (Pink)
KVM Ports	2 x HDMI Male (Black) 2 x USB Type A Male (Purple) 2 x USB Type A Male (Black) 2 x 3.5mm Audio Jack Male (Green) 2 x 3.5 mm Audio Jack Male (Pink)
Port Selection	Hotkey, Remote Port Selector, Mouse
Cable Length	
Computer	2 x 1.2 m
Remote Port Selector	1.8 m
Emulation	
Keyboard / Mouse	USB
Video	1920 x 1080 @ 60Hz; 1920 x 1200 @ 60Hz
LEDs	
KVM	2 (Green)
Power Consumption	DC5V: 1.76W
Environmental	
Operating Temperature	0 - 50°C
Storage Temperature	-20 - 60°C
Humidity	0-80% RH, Non-condensing
Physical Properties	
Housing	Plastic
Weight	0.48 kg (1.06 lb)
Dimensions (L x W x H)	8.24 x 6.65 x 2.52 cm (3.24 x 2.62 x 0.99 in.)
Carton Lot	10 pcs

Optional Accessory

Type	Part No. / Spec.	Page No.
USB Hub	UH275 / UH284	10-35

CS682

2-Port USB DVI/Audio Cable KVM Switch with Remote Port Selector

Our Top-of-the Range DVI Cable KVM Switch + Video DynaSync™



Features

- USB 2.0 mouse port can be used as a USB hub and for USB peripheral sharing
- [Video DynaSync™ – exclusive ATEN technology eliminates boot-up display problems and optimizes the resolution when switching between ports](#)
- Independent switching of the KVM and audio focus – KVM is focused on one computer while the audio is focused on the other
- Firmware upgradable
- One DVI console controls two USB DVI computers
- Fully DVI-Digital specification compliant
- Audio-enabled – full bass response provides a rich experience for 2.1 channel surround sound systems
- Compact design, all-in-one cables (2 x 1.2 m) built-in
- Power on detection – if either of the computers is powered off, the CS682 will automatically switch to the other computer
- Compatible with widescreen LCD monitors and wireless sets
- Supports multimedia keyboards and multifunction mice
- HDCP compatible
- Bus-powered – no external power adapter required

Specifications

Function	CS682
Computer Connections	2
Connectors	
Console Ports	1 x DVI-D Female (White), 2 x USB Type A Female, 1 x 3.5 mm Audio Jack Female (Green), 1 x 3.5 mm Audio Jack Female (Pink)
KVM Ports	2 x DVI-D Male (Black), 2 x USB Type A Male (Purple), 2 x USB Type A Male (Black), 2 x 3.5 mm Audio Jack Male (Green), 2 x 3.5 mm Audio Jack Male (Pink)
Remote Port Selector	1 x 2.5 mm Audio Jack
Port Selection	Hotkey, Mouse, Remote Port Selector
Cable Length	
KVM	2 x 1.2 m
Remote Port Selector	1.8 m
Emulation	
Keyboard / Mouse	USB
Video	1920 x 1200 @ 60Hz
LEDs	
Computer	2 (Green)
Remote Port Selector	2 (Green)
Power Consumption	DC5V: 1.95W
Environmental	
Operating Temperature	0 - 50°C
Storage Temperature	-20 - 60°C
Humidity	0 - 80% RH, Non-condensing
Physical Properties	
Housing	Plastic
Weight	0.49 kg (1.08 lb)
Dimensions (L x W x H)	11.15 x 7.80 x 2.40 cm (4.39 x 3.07 x 0.94 in.)
Carton Lot	10 pcs
Included Accessories	1x Remote Port Selector

CS22D

2-Port USB DVI Cable KVM Switch with Remote Port Selector

Simply Click to Select Computers



Features

- Remote port selector for convenient switch placement
- Mini-USB connector for optional external USB power
- USB 2.0 mouse port can be used for USB peripheral sharing
- One DVI-D video console controls two USB DVI-D interface computers
- Compact design, all-in-one cables (2 x 1.2 m) built-in
- Supports USB hot-plugging
- Supports multifunction mice
- Bus-powered – no external power adapter required

Specifications

Function	CS22D
Computer Connections	2
Connectors	
Console Ports	1 x DVI-I Female (Black) 2 x USB Type A Female 1 x USB Mini-B Female
KVM Ports	2 x DVI-D Male (Black) 2 x USB Type A Male
Port Selection	Remote Port Selector
Cable Length	
Computer	2 x 1.2 m
Remote Port Selector	1.8 m
Video Resolution	1920 x 1200 @ 60Hz
LEDs	
Selected	2 (Green)
Power Consumption	DC5V: 0.93W
Environmental	
Operating Temperature	0 - 50°C
Storage Temperature	-20 - 60°C
Humidity	0 - 80% RH, Non-condensing
Physical Properties	
Housing	Plastic
Weight	0.34 kg (0.75 lb)
Dimensions (L x W x H)	9.96 x 9.36 x 3.01 cm (3.92 x 3.69 x 1.19 in.)
Carton Lot	20 pcs

CS62U / CS62US

2-Port USB VGA/Audio Cable KVM Switch

Multiplatform USB Cable KVM Switch



Features

- [Video DynaSync™](#) – exclusive ATEN technology that eliminates boot-up display problems and optimizes the resolution when switching between ports
- Console mouse port emulation / bypass feature supports most mouse drivers
- Supports gaming and multimedia keyboards
- Supports multifunction and wireless keyboards and mice
- One USB console controls two USB computers
- Compact design, built-in 1.8 m cables (CS62U), 0.9 m cables (CS62US)
- Select OS via hotkey
- USB mouse port can be used as a USB 1.1 hub and for USB 1.1 peripheral sharing
- All-in-one design
- Auto Scan function to monitor computer operation
- Bus-powered – no external power adapter required

Specifications

Function	CS62U	CS62US
Computer Connections	2	2
Connectors		
Console Ports	1 x HDB-15 Female (Blue) 2 x USB Type A Female 1 x 3.5 mm Audio Jack Female (Green)	
KVM Ports	2 x HDB-15 Male (Blue) 2 x USB Type A Male (Black) 2 x 3.5mm Audio Jack Male (Green)	
Port Selection	Hotkey, Mouse	
Cable Length		
Computer	2 x 1.8 m	2 x 0.9 m
Emulation	USB	
Keyboard / Mouse	USB	
Video	2048 x 1536; DDC2B	
LEDs		
Selected	2 (Green)	
Power Consumption	DC5V: 0.33W	
Environmental		
Operating Temperature	0 - 50°C	
Storage Temperature	-20 - 60°C	
Humidity	0-80% RH, Non-condensing	
Physical Properties		
Housing	Plastic	
Weight	0.37 kg (0.81 lb)	0.28 kg (0.62 lb)
Dimensions (L x W x H)	8.75 x 6.08 x 2.80 cm (3.44 x 2.39 x 1.1 in.)	
Carton Lot	20 pcs	

CS64U / CS64US

4-Port USB VGA/Audio Cable KVM Switch



Features

- Compact design, built-in 1.8 m cables (CS64U), 0.9 / 1.2 m cables (CS64US)
- [Video DynaSync™ – exclusive ATEN technology eliminates boot-up display problems and optimizes the resolution when switching between ports](#)
- Firmware upgradable
- One USB console controls four USB VGA computers
- USB mouse port can be used as a USB 1.1 hub and for USB 1.1 peripheral sharing
- Supports multimedia USB keyboards and multifunction mice
- Supports wireless keyboards and mice
- All-in-one design
- Auto Scan function to monitor computer operation
- Bus-powered – no external power adapter required

Specifications

Function	CS64U	CS64US
Computer Connections	4	
Connectors		
Console Ports	1 x HDB-15 Female (Blue) 2 x USB Type A Female 1 x 3.5 mm Audio Jack Female (Green)	
KVM Ports	4 x HDB-15 Male (Blue) 4 x USB Type A Male (Black) 4 x 3.5mm Audio Jack Male (Green)	
Port Selection	Hotkey	
Cable Length		
Computer	4 x 1.8 m	2 x 0.9 m; 2 x 1.2 m
Emulation		
Keyboard / Mouse	USB	
Video	2048 x 1536; DDC2B	
LEDs		
Selected	4 (Green)	
Power Consumption	DC5V: 0.9W	
Environmental		
Operating Temperature	0 – 50°C	
Storage Temperature	-20 – 60°C	
Humidity	0 – 80% RH, Non-condensing	
Physical Properties		
Housing	Plastic	
Weight	0.73 kg (1.61 lb)	0.58 kg (1.28 lb)
Dimensions (L x W x H)	9.41 x 9.72 x 2.60 cm (3.7 x 3.83 x 1.02 in.)	
Carton Lot	5 pcs	

CS22U

2-Port USB VGA Cable KVM Switch with Remote Port Selector

Simply Click to Select Computers



Features

- Remote port selector for convenient switch placement
- USB mouse port can be used as a USB 1.1 hub and for USB 1.1 peripheral sharing
- One USB console controls two USB computers
- Compact design, built-in 0.9 m cables
- Supports multifunction mice
- Bus-powered – no external power adapter required

Specifications

Function	CS22U
Computer Connections	2
Connectors	
Console Ports	1 x HDB-15 Female (Blue) 2 x USB Type A Female
KVM Ports	2 x HDB-15 Male (Blue) 4 x USB Type A Male (Black)
Port Selection	Remote Port Selector
Cable Length	
Computer	2 x 0.9 m
Remote Port Selector	1.8 m
Video	2048 x 1536; DDC2B
LEDs	
Selected	2
Power Consumption	DC5V: 0.14W
Environmental	
Operating Temperature	0-50°C
Storage Temperature	-20-60°C
Humidity	0-80% RH, Non-condensing
Physical Properties	
Housing	Plastic
Weight	0.30 kg (0.66 lb)
Dimensions (L x W x H)	8.24 x 7.01 x 2.46 cm (3.24 x 2.76 x 0.97 in.)
Carton Lot	20 pcs

CS52A

2-Port PS/2 USB VGA/Audio Cable KVM Switch with Remote Port Selector

Flexible Combinations: PS/2 Keyboard + USB Mouse



Features

- Remote port selector for convenient switch placement
- USB 2.0 mouse port can be used as a USB hub and for USB peripheral sharing
- Independent switching of the KVM and Audio focus – KVM is focused on one computer while the Audio is focused on the other
- One console (monitor, PS/2 keyboard and USB mouse) controls two computers
- Supports multifunction mice
- Compact design, all-in-one cables (console 0.15 m, computers 0.6 m, 1.2 m) built-in
- Audio (microphone and speaker) enabled – full bass response provides a rich experience for 2.1 surround sound systems
- Auto Scan function to monitor computer operation
- Bus-powered – no external power adapter required

Specifications

Function	CS52A
Computer Connections	2
Connectors	
Console Ports	1 x HDB-15 Female (Blue) 1 x 6-pin Mini-DIN Female (Purple) 1 x USB Type A Female 1 x 3.5 mm Audio Jack Female (Green) 1 x 3.5 mm Audio Jack Female (Pink)
KVM Ports	2 x HDB-15 Male (Blue) 2 x 6-pin Mini-DIN Male (Purple) 2 x USB Type A Male (Black) 2 x 3.5 mm Audio Jack Male (Green) 2 x 3.5 mm Audio Jack Male (Pink)
Remote Port Selector	1 x 2.5 mm Audio Jack
Port Selection	Hotkey, Remote Port Selector
Cable Length	
Console	0.15 m
Computer	1 x 0.6 m; 1 x 1.2 m
Emulation	
Keyboard / Mouse	PS/2
Video	2048 x 1536; DDC2B
LEDs	
Selected	2 (Green)
Power Consumption	DC5V: 0.25W
Environmental	
Operating Temperature	0-50°C
Storage Temperature	-20-60°C
Humidity	0-80% RH, Non-condensing
Physical Properties	
Housing	Plastic
Weight	0.40 kg (0.88 lb)
Dimensions (L x W x H)	8.45 x 3.40 x 2.21 cm (3.33 x 1.34 x 0.87 in.)
Carton Lot	20 pcs
Included Accessories	1x Remote Port Selector

Optional Accessory

Type	Part No. / Spec.	Page No.
USB Hub	UH275 / UH284	10-35

CS52

2-Port PS/2 USB VGA Cable KVM Switch with Remote Port Selector

Flexible Combinations: PS/2 keyboard + USB Mouse



6

Cable KVM Switches



Features

- Remote port selector for convenient switch placement
- USB 2.0 mouse port can be used as a USB hub and for USB peripheral sharing
- One console (monitor, PS/2 keyboard and USB mouse) controls two computers
- Supports multifunction mice
- Compact design, all-in-one cables (console 0.15 m, computers 0.6 m, 1.2 m) built-in
- Auto Scan function to monitor computer operation
- Bus-powered – no external power adapter required

Specifications

Function	CS52
Computer Connections	2
Connectors	
Console Ports	1 x HDB-15 Female (Blue) 1 x 6-pin Mini-DIN Female (Purple) 1 x USB Type A Female
KVM Ports	2 x HDB-15 Male (Blue) 2 x 6-pin Mini-DIN Male (Purple) 2 x USB Type A Male (Black)
Remote Port Selector	1 x 2.5 mm Audio Jack
Port Selection	Hotkey, Remote Port Selector
Cable Length	
Console	0.15 m
Computer	1 x 0.6 m; 1 x 1.2 m
Emulation	
Keyboard / Mouse	PS/2
Video	2048 x 1536; DDC2B
LEDs	
Selected	2 (Green)
Power Consumption	DC5V: 0.02W
Environmental	
Operating Temperature	0-50°C
Storage Temperature	-20-60°C
Humidity	0-80% RH, Non-condensing
Physical Properties	
Housing	Plastic
Weight	0.35 kg (0.77 lb)
Dimensions (L x W x H)	8.45 x 3.40 x 2.21 cm (3.33 x 1.34 x 0.87 in.)
Carton Lot	20 pcs
Included Accessories	1x Remote Port Selector

Optional Accessory

Type	Part No. / Spec.	Page No.
USB Hub	UH275 / UH284	10-35

CS62S

2-Port PS/2 VGA Cable KVM Switch



Features

- One PS/2 console controls two PS/2 computers
- Compact design, built-in 0.9 m cables
- Auto Scan function to monitor computer operation
- Bus-powered – no external power adapter required

Specifications

Function	CS62S
Computer Connections	2
Connectors	
Console Ports	1 x HDB-15 Female (Blue) 1 x 6-pin Min-DIN Female (Purple) 1 x 6-pin Min-DIN Female (Green)
KVM Ports	2 x HDB-15 Male (Blue) 2 x 6-pin Min-DIN Male (Purple) 2 x 6-pin Min-DIN Male (Green)
Port Selection	Hotkey
Cable Length	
Computer	2 x 0.9 m
Emulation	
Keyboard / Mouse	PS/2
Video	2048 x 1536; DDC2B
LEDs	
Selected	2 (Green)
Power Consumption	DC5V: 0.17W
Environmental	
Operating Temperature	0-50°C
Storage Temperature	-20-60°C
Humidity	0-80% RH, Non-condensing
Physical Properties	
Housing	Plastic
Weight	0.25 kg (0.55 lb)
Dimensions (L x W x H)	7.30 x 6.24 x 2.25 cm (2.87 x 2.46 x 0.89 in.)
Carton Lot	20 pcs

CS62A / CS64A

2 / 4-Port PS/2 VGA/Audio Cable KVM Switch

With Audio Support



• CS62A



• CS64A



Features

- One PS/2 console controls 2 / 4 PS/2 computers
- Compact design, built-in 1.2 m (CS62A), 1.8 m (CS64A) all-in-one cables
- Auto Scan function to monitor computer operation
- Bus-powered – no external power adapter required

Specifications

Function	CS62A	CS64A
Computer Connections	2	4
Connectors		
Console Ports	1 x HDB-15 Female (Blue) 1 x 6-pin Mini-DIN Female (Purple) 1 x 6-pin Mini-DIN Female (Green) 1 x 3.5 mm Audio Jack Female (Green)	
KVM Ports	2 x HDB-15 Male (Blue) 2 x 6-pin Mini-DIN Male (Purple) 2 x 6-pin Mini-DIN Male (Green) 2 x 3.5 mm Audio Jack Male (Green)	4 x HDB-15 Male (Blue) 4 x 6-pin Mini-DIN Male (Purple) 4 x 6-pin Mini-DIN Male (Green) 4 x 3.5 mm Audio Jack Male (Green)
Port Selection	Hotkey	
Cable Length		
Computer	2 x 1.2 m	4x 1.8 m
Emulation	PS/2	
Video	2048 x 1536; DDC2B	
LEDs		
Selected	2 x Green	4 x Green
Power Consumption	DC5V: 0.22W	DC5V: 0.41W
Environmental		
Operating Temperature	0-50°C	
Storage Temperature	-20-60°C	
Humidity	0~80% RH, Non-condensing	
Physical Properties		
Housing	Plastic	
Weight	0.30 kg (0.66 lb)	0.67 kg (1.48 lb)
Dimensions (L x W x H)	8.40 x 5.40 x 3.00 cm (3.31 x 2.13 x 1.18 in.)	7.86 x 7.86 x 3.06 cm (3.09 x 3.09 x 1.2 in.)
Carton Lot	20 pcs	



Desktop KVM Switches

ATEN desktop KVM switches provide both ergonomic style and advanced functionality for the SOHO desktop environment. Desktop KVM switches allow you to switch and manage up to four PCs with various video types, such as USB-C, DisplayPort, HDMI, DVI or VGA, and share USB peripherals and multi-channel audio functionality from one single-screen to three-screen console.



- **Boundless Switching**

ATEN Boundless Switching technology provides intuitive mouse cursor switching by moving your mouse across screen/window boundaries to switch between video sources.

- **Integrated USB Hub**

The KVMP Switch's design provides USB hub functionality – allowing USB peripherals to connect to the switch and be shared by all the computers on the installation.

- **Integrated High Definition Audio**

Featuring support for multi-channel digital audio formats – including Dolby True HD, DTS HD Master Audio, 2.1 and 7.1 Surround Sound – users can enjoy a true high definition audio experience.

- **Dual Display – Dual View**

The Dual Display function is ideal for multimedia power users since it supports a separate output on each monitor. Users can have the display of the computer they are using on one monitor, while they keep an eye on the video output of the other computers on the second one, allowing the video output to seamlessly display on two monitors.

- **Up to 4K UHD Resolution with a Wide Range of Video Standards**

All ATEN desktop KVM solutions offer stunning video quality in a range of video standards, including USB-C, DisplayPort, HDMI, Dual Link DVI, and more, allowing you to keep pace with the boom in 4K DCI (4096 x 2160 @ 60Hz) video content across all sectors and take full advantage of the benefits of visual excellence in terms of both work efficiency and viewing pleasure.

- **Video DynaSync™**

ATEN's exclusive Video DynaSync™ technology automatically detects the horizontal and vertical offset values of each computer's display settings and synchronizes them with the monitor you are working on, ensuring that the display resolution will always be correct when switching ports.

- **Interface Flexibility**

For the convenience and flexibility of having both PS/2 and USB interface computers on the same installation, many ATEN KVM switches provide custom cables with both PS/2 and USB connectors.

- **Flexible Focus Assignment**

The KVM, audio and USB focus can all be assigned to one computer, or assigned independently. Assigning the focus independently means that users can give one computer the KVM console focus, another the USB hub focus, while a third has the audio focus.

Note:

The features highlighted above are not available in all products. Please refer to each product page for more details.

Product information is subject to change without prior notice.

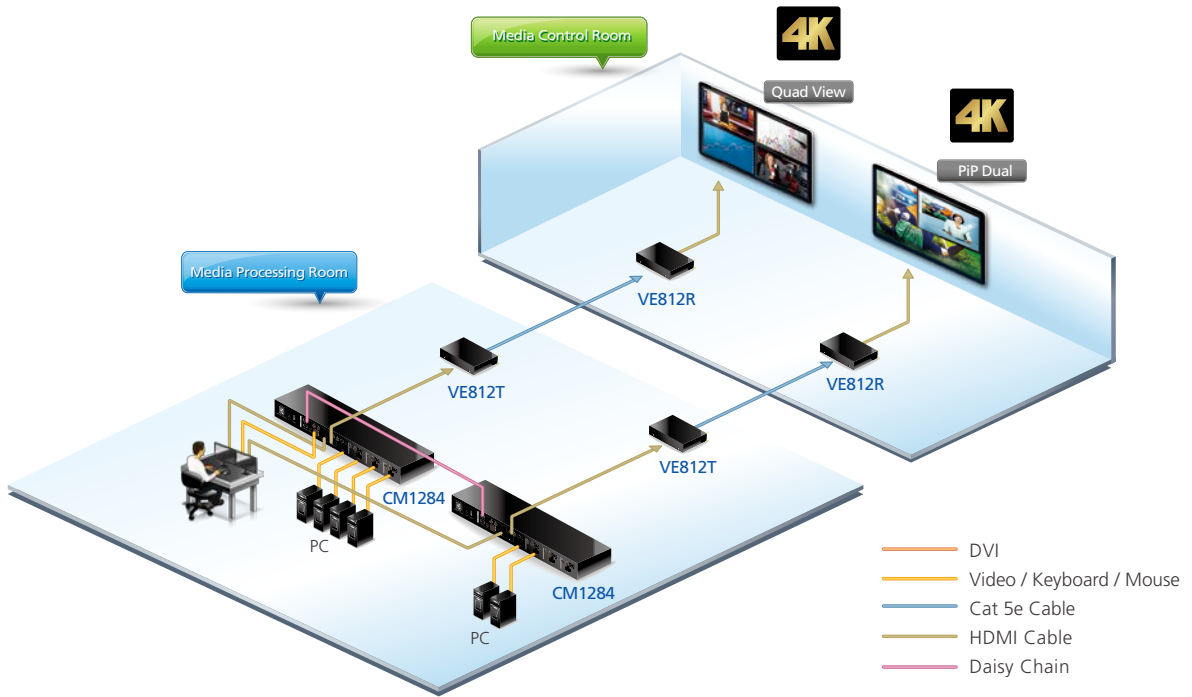

Feature Comparison

Model No.	CM1284	CM1164A	CS724KM	CS1953	CS1964	CS1944DP	CS1942DP
Ports	4	4	4	2	4	4	2
Interface	Keyboard, Mouse	USB	USB	USB	USB	USB	USB
	Video	HDMI	DVI (Single Link)	N/A	DisplayPort/USB-C*	DisplayPort/HDMI**	DisplayPort
Platform Support	Windows, Linux, Mac, Sun	Windows, Linux, Mac, Sun	Windows	Windows, Linux, Mac	Windows, Linux, Mac	Windows, Linux, Mac	Windows, Linux, Mac
USB Hub Built-in	•	•	•	• (USB 3.1 Gen 1)	• (USB 3.1 Gen 1)	• (USB 3.1 Gen 1)	• (USB 3.1 Gen 1)
Audio	•	•	• (Speakers)	•	•	•	•
Independent Switching	•	•	•	•	•	•	•
Video DynaSync™	•	•	N/A	N/A	•	N/A	N/A
Dual Display	•	N/A	N/A	N/A	• (Triple Display)	•	•
3D Support	N/A	N/A	N/A	N/A	N/A	•	•
Port Selection	Hotkeys, Pushbuttons, IR Remote Control, OSD, RS-232 commands	Hotkey, Pushbutton, IR Remote Control, OSD, Mouse, RS-232 commands	Hotkey, Pushbutton, Mouse Wheel, Mouse Cursor, RS-232 commands	Hotkey, Pushbutton, Mouse, Remote Port Selector	Hotkey, Pushbutton, Mouse, RS-232 commands	Hotkey, Pushbutton, Mouse, RS-232 commands	Hotkey, Pushbutton, Mouse, RS-232 commands

Note: * USB-C transfers video, audio, and data.

** The HDMI port is located in the console section at the back of the switch.

Model No.	CS1924M	CS1922M	CS1924	CS1922	CS1914	CS1912
Ports	4	2	4	2	4	2
Interface	Keyboard, Mouse	USB	USB	USB	USB	USB
	Video	DisplayPort / HDMI***	DisplayPort / HDMI**	DisplayPort	DisplayPort	DisplayPort
Platform Support	Windows, Linux, Mac	Windows, Linux, Mac	Windows, Linux, Mac	Windows, Linux, Mac	Windows, Linux, Mac	Windows, Linux, Mac
USB Hub Built-in	• (USB 3.1 Gen 1)	• (USB 3.1 Gen 1)	• (USB 3.1 Gen 1)	• (USB 3.1 Gen 1)	• (USB 3.1 Gen 1)	• (USB 3.1 Gen 1)
Audio	•	•	•	•	• (Speakers)	• (Speakers)
Independent Switching	•	•	•	•	•	•
Video DynaSync™	N/A	N/A	N/A	N/A	N/A	N/A
Dual Display	•	•	N/A	N/A	N/A	N/A
3D Support	N/A	N/A	N/A	N/A	N/A	N/A
Port Selection	Hotkey, Pushbutton, Mouse, RS-232 commands	Hotkey, Pushbutton, Mouse, RS-232 commands	Hotkey, Pushbutton, Mouse	Hotkey, Pushbutton, Mouse	Hotkey, Pushbutton, Mouse	Hotkey, Pushbutton, Mouse

Model No.	CS782DP	CS1824	CS1822	CS1794	CS1792	CS1644A	CS1642A
Ports	2	2	4	4	2	4	2
Interface	Keyboard, Mouse	USB	USB	USB	USB	USB	USB
	Video	DisplayPort	HDMI	HDMI	HDMI	HDMI	DVI (Dual Link)
Platform Support	Windows, Linux, Mac, Sun	Windows, Linux, Mac, Sun	Windows, Linux, Mac, Sun	Windows, Linux, Mac	Windows, Linux, Mac	Windows, Linux, Mac, Sun	Windows, Linux, Mac, Sun
USB Hub Built-in	N/A	• (USB 3.1 Gen 1)	• (USB 3.1 Gen 1)	•	•	•	•
Audio	• (Speakers)	• (Speakers)	• (Speakers)	•	•	•	•
Independent Switching	•	•	•	•	•	•	•
Video DynaSync™	N/A	•	•	•	•	•	•
Dual Display	N/A	N/A	N/A	N/A	N/A	•	•
3D Support	N/A	N/A	N/A	N/A	N/A	•	•
Port Selection	Hotkey, Mouse, Remote Port Selector	Hotkey, Pushbutton, Mouse, RS-232 commands	Hotkey, Pushbutton, Mouse, RS-232 commands	Hotkey, Pushbutton	Hotkey, Pushbutton	Hotkey, Pushbutton, Mouse	Hotkey, Pushbutton, Mouse

Model No.		CS1784A	CS1782A	CS1764A	CS1762A	CS72D
Ports		4	2	4	2	2
Interface	Keyboard, Mouse	USB	USB	USB	USB	USB
	Video	DVI (Dual Link)	DVI (Dual Link)	DVI	DVI	DVI
Platform Support		Windows, Linux, Mac, Sun	Windows, Linux, Mac, Sun	Windows, Linux, Mac, Sun	Windows, Linux, Mac, Sun	Windows, Linux, Mac, Sun
USB Hub Built-in		•	•	•	•	N/A
Audio		•	• (7.1)	•	•	•
Independent Switching		•	•	•	•	•
Video DynaSync™		•	•	•	•	•
Dual Display		N/A	N/A	N/A	N/A	N/A
3D Support		•	•	N/A	N/A	N/A
Port Selection		Hotkey, Pushbutton, Mouse	Hotkey, Pushbutton, Mouse	Hotkey, Pushbutton, Mouse	Hotkey, Pushbutton, Mouse	Hotkey, Pushbutton, Mouse

Model No.		CS1744	CS1742	CS1734B	CS1732B	CS1734A	CS1732A
Ports		4	2	4	2	4	2
Interface	Keyboard, Mouse	USB	USB	PS/2, USB	PS/2, USB	PS/2, USB	PS/2, USB
	Video	VGA (SPHD)	VGA (SPHD)	VGA (SPHD)	VGA (SPHD)	VGA (SPHD)	VGA (SPHD)
Platform Support		Windows, Linux, Mac, Sun	Windows, Linux, Mac, Sun	Windows, Linux, Mac, Sun	Windows, Linux, Mac, Sun	Windows, Linux, Mac, Sun	Windows, Linux, Mac, Sun
USB Hub Built-in		•	•	•	•	•	•
Audio		•	•	•	•	•	•
Independent Switching		•	•	•	•	•	•
Video DynaSync™		N/A	N/A	•	•	N/A	N/A
Dual Display		•	•	N/A	N/A	N/A	N/A
3D Support		N/A	N/A	N/A	N/A	N/A	N/A
Port Selection		Hotkey, Pushbutton	Hotkey, Pushbutton	Hotkey, Pushbutton, OSD, Mouse	Hotkey, Pushbutton, OSD, Mouse	Hotkey, Pushbutton	Hotkey, Pushbutton

Model No.		CS84U	CS82U	CS74U	CS72U	CS84A	CS82A	CS74E
Ports		4	2	4	2	4	2	4
Interface	Keyboard, Mouse	PS/2, USB	PS/2, USB	USB	USB	PS/2	PS/2	PS/2
	Video	VGA (SPHD)	VGA (SPHD)	VGA (SPHD)	VGA (SPHD)	VGA	VGA	VGA (SPHD)
Platform Support		Windows, Linux, Mac, Sun	Windows, Linux, Mac, Sun	Windows, Linux, Mac, Sun	Windows, Linux, Mac, Sun	Windows, Linux	Windows, Linux	Windows, Linux
USB Hub Built-in		N/A	N/A	N/A	N/A	N/A	N/A	N/A
Audio		N/A	N/A	•	•	N/A	N/A	N/A
Independent Switching		N/A	N/A	N/A	N/A	N/A	N/A	N/A
Video DynaSync™		•	•	N/A	N/A	N/A	N/A	N/A
Dual Display		N/A	N/A	N/A	N/A	N/A	N/A	N/A
3D Support		N/A	N/A	N/A	N/A	N/A	N/A	N/A
Port Selection		Hotkey, Pushbutton, Mouse	Hotkey, Pushbutton, Mouse	Pushbutton	Pushbutton	Hotkey, Pushbutton	Hotkey, Pushbutton	Hotkey, Pushbutton

CM1284

4-Port USB 4K HDMI Multi-View KVM™ Switch



Console USB
Computers USB
Multi View
Expansion Daisy Chain
Expansion Cascade
Boundless Switching
Audio Mic. & Speaker
USB 2.0 Peripherals
VDS Video DynaSync

7 Desktop KVM Switches



Front



Rear



Features

- Multi-view console controls up to four video sources on one screen with display modes including Quad View, Picture in Picture (PiP), Picture by Picture (PbP), and Picture on Picture (PoP)
- Features dual output on console side – a multi-view output and a full screen output
- Easily resizes and / or reposition any PiP or PbP to suit users' viewing needs
- System configuration via front panel, OSD, IR Remote, and RS-232 commands – display mode and port selection
- Supports superior video quality – Up to 4K (4096 x 2160 @ 30 Hz)
- Drop down menu – edit display windows and other functions with the mouse and on-screen control panel
- Computer selection via front panel pushbutton and hotkey, mouse¹, and the serial commands
- **Boundless Switching** – Simply moves the mouse cursor across windows to switch to other video sources
- **Video DynaSync™** – exclusive ATEN technology eliminates boot-up display problems and optimizes the resolution when switching among different sources
- **EDID Expert™** – Selects optimum EDID settings for smooth power-up, high-quality display and use of the best video resolution across different screens
- DCC (Daisy Chain Control) – Controls up to 3 additional CM1284 units from a single console
- Cascade up to 2 levels – Controls up to 16 computers (with up to 4 x 4 Multi-view mode)
- HDCP 1.4 compliant
- Console keyboard emulation / bypass feature
- Console mouse port emulation / bypass feature
- Independent switching for USB peripheral port, audio function and KVM switch focus
- Firmware upgradable via computer's USB port
- Multilingual keyboard mapping – supports English, French, Japanese, and German keyboards
- Supports keyboard combinations via emulation (for Sun / Mac)²

Note:

1. Mouse port switching is only workable under mouse emulation mode and is for 3-key USB wheel mouse only
2. PC keyboard combinations emulate Mac keyboard. Mac keyboard only work with their own computers

Setup > CM1284

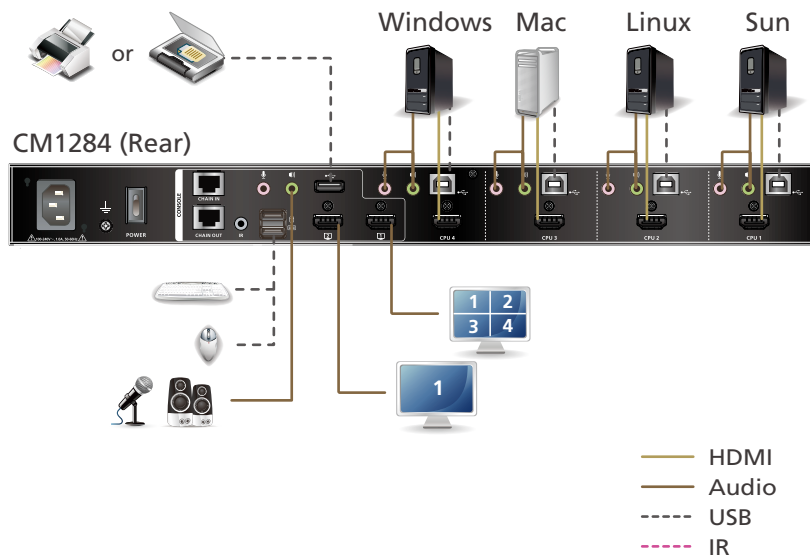

- ▶ **Quad View** displays all four computers / video sources on the display



- **PiP Dual** – shows two computers / video sources, with only half of the actual display visible



- **PiP Triple** – shows three computers / video sources at one time



- **PiP Quad** – shows four computers / video sources at one time, but unlike in Quad View, one display takes up the whole screen, while the other three displays are occupying only the right side of the screen



Note: The screen size of the each display depends on the resolution of the computer / video source connected to the port

Specifications

Function	CM1284
Computer Connections	4
Port Selection	Pushbutton, Hotkey, IR Remote Control, On-Screen Display(OSD), RS-232 Commands
Connectors	
Console Ports	2 x USB Type A Female 2 x HDMI Female (Black) 2 x 3.5mm Audio Jack Female (Green; 1 x front panel, 1 x rear panel) 2 x 3.5mm Audio Jack Female (Pink; 1 x front, 1 x rear) 2 x RJ-45
KVM (Computer) Ports	4 x USB Type B Female (White) 4 x HDMI Female (Black) 4 x 3.5mm Audio Jack Female (Green) 4 x 3.5mm Audio Jack Female (Pink)
Power	1 x IEC320 Jack
USB Hub	2 x USB 2.0 Type A Female (1 x front panel; 1 x rear panel)
Switches	
Selected	11 x Pushbuttons
Emulation	
Keyboard / Mouse	USB
Video	4096 x 2160 @ 30Hz
LEDs	
KVM	4 (Orange)
Audio	4 (Green)
USB	4 (Green)
Maximum Input Power Rating	100-240 VAC; 50/60Hz; 1A
Power Consumption	AC110V: 16.0W / AC220V: 14.8W
Environmental	
Operating Temperature	0 - 50°C
Storage Temperature	-20 - 60°C
Humidity	0-95% RH, Non-condensing
Physical Properties	
Housing	Metal
Weight	2.46 kg (5.42 lb)
Dimensions (L x W x H)	43.72 x 16.40 x 4.40 cm (17.21 x 6.46 x 1.73 in.)
Carton Lot	3 pcs
Included Accessories	4x USB HDMI Cables; 1x Power Cord; 1x IR Remote Control; 1x Rack Mount Kit

Optional Accessories

Type	Part No. / Spec.	Page No.
USB HDMI KVM Cables	2L-7D02UH (1.8 m)	12-3 T
IR Extender Cable	2XRT-0003G	12-4

CM1164A

4-Port USB DVI Multi-View KVM™ Switch



Front



Rear



Features

- Multi-view console controls up to four video sources on one screen with display modes including Quad View, Picture in Picture (PiP), Picture by Picture (PbP), and Picture on Picture (PoP)
- System configuration via front panel, OSD, IR Remote – display mode and port selection
- Easily resize and / or reposition any PiP or PbP to suit users' viewing needs
- DCC (Daisy Chain Control) — Controls up to 3 additional CM1164A units from a single console
- Cascade up to 2 levels — Controls up to 16 computers (with up to 4 x 4 Multi-view mode)
- **Boundless Switching** – Simply moves the mouse cursor across windows to switch to other video sources
- **Video DynaSync™** – exclusive ATEN technology eliminates boot-up display problems and optimizes the resolution when switching among different sources
- HDCP 1.4 compliant
- Supports RS-232 commands
- Drop down menu – edit display windows and other functions with the mouse and on-screen control panel
- Console mouse port emulation / bypass feature that supports most mouse drivers and multifunction mice
- Console keyboard emulation / bypass feature that support most multimedia keyboards
- Independent switching for USB peripheral port, audio function and KVM switch focus
- Auto Scan feature
- Power on detection
- Multilingual keyboard mapping – supports English, French, Japanese, and German keyboards
- Full bass response provides a rich experience for 2.0 channel audio
- Supports keyboard combinations via emulation (for Sun / Mac)

Setup > CM1164A

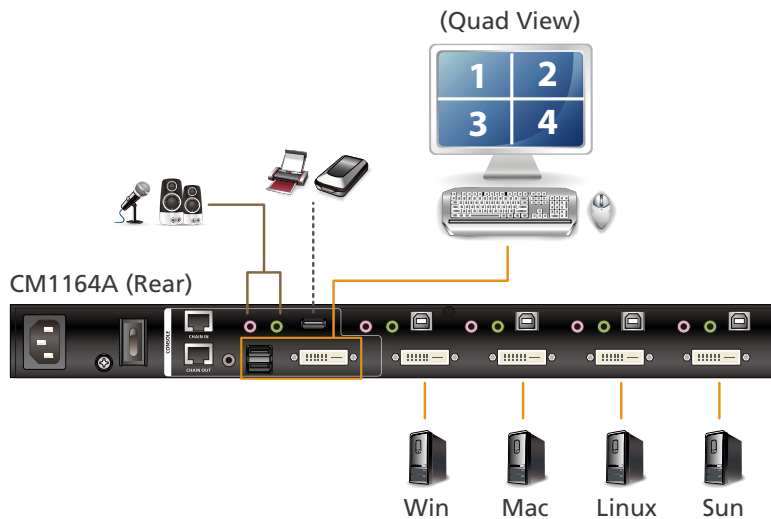

- Video / Keyboard / Mouse
- - - - - USB
- Audio
- Cat 5e Cable

- ▶ **Quad View** displays all four computers / video sources on the display



- **PiP Dual** – shows two computers / video sources, with only half of the actual display visible



- **PiP Triple** – shows three computers / video sources at one time



- **PiP Quad** – shows four computers / video sources at one time, but unlike in Quad View, one display takes up the whole screen, while the other three displays are occupying only the right side of the screen



Note: The screen size of the each display depends on the resolution of the computer / video source connected to the port

Specifications

Function	CM1164A
Computer Connections	4
Port Selection	Pushbuttons, Hotkeys, IR Remote Control, On-Screen Display (OSD), Mouse, RS-232 Commands
Connectors	
Console Ports	2 x USB Type A Female 1 x Single Link DVI-D Female (White) 2 x 3.5mm Audio Jack Female (Green; 1 x front panel, 1 x rear panel) 2 x 3.5mm Audio Jack Female (Pink; 1 x front, 1 x rear) 2 x RJ-45
KVM Ports	4 x USB Type B Female 4 x Single Link DVI-D Female (White) 4 x 3.5mm Audio Jack Female (Green) 4 x 3.5mm Audio Jack Female (Pink)
Power	1 x IEC320 Jack
USB Hub	2 x USB 2.0 Type A Female
Emulation	
Keyboard / Mouse	USB
Switches	
Selected	11 x Pushbuttons
Video	1920 x 1200 @ 60Hz (DVI-D)
LEDs	
KVM	4 (Orange)
Audio	4 (Green)
USB	4 (Green)
Power Consumption	AC110V: 9.7W / AC220V: 9.5W
Environmental	
Operating Temperature	0 - 40°C
Storage Temperature	-10 - 60°C
Humidity	0-80% RH, Non-condensing
Physical Properties	
Housing	Metal
Weight	2.46 kg (5.42 lb)
Dimensions (L x W x H)	43.72 x 16.40 x 4.40 cm (17.21 x 6.46 x 1.73 in.)
Carton Lot	3 pcs
Included Accessories	4x KVM Cables (DVI-D, USB, Audio); 1x Power Cord; 1x IR Remote Control; 1x Rack Mount Kit

Optional Accessories

Type	Part No. / Spec.	Page No.
USB DVI Single Link KVM Cables	2L-7D02U (1.8 m), 2L-7D03U (3 m), 2L-7D05U (5 m)	12-3 O
IR Extender Cable	2XRT-0003G	12-4

CS724KM

4-Port USB Boundless KM Switch



Front



Rear



Features

- Single keyboard and mouse control up to 4 computers
- **Boundless Switching** - allows users to switch between computers when the mouse cursor crosses the display border
- Daisy-Chain two units to control 8 computers with a single keyboard and mouse
- Independently switch KVM, USB hub and audio port focus via hotkeys
- Port selection via pushbutton, hotkey, mouse cursor, mouse wheel and RS-232 commands
- Supports RS-232 serial commands
- Supports Windows
- No software required
- Bus-powered – no external power adapter required

Specifications

Function	CS724KM
Computer Connections	4
Port Selection	Hotkey, Pushbutton, Mouse Wheel, Mouse Cursor, RS-232 Commands
Connectors	
Console Ports	2 x USB Type A Female 2 x 3.5 mm Audio Jack Female (Green; 1 x front, 1 x rear) 1 x RJ-45
KVM (Computer) Ports	4 x USB Type B Female 4 x 3.5 mm Audio Jack Female (Green)
Power	1 x DC Jack
USB Hub	2 x USB 2.0 Type A Female (1 x front panel; 1 x rear panel)
LEDs	
Selected	4 (Green)
Emulation	
Keyboard / Mouse	USB
Power Consumption	DC5V:1.69W
Environmental	
Operating Temperature	0 – 50°C
Storage Temperature	-20 – 60°C
Humidity	0–80% RH, Non-condensing
Physical Properties	
Housing	Metal + Plastic
Weight	0.5 kg (1.10 lb)
Dimensions (L x W x H)	20.00 x 8.06 x 2.50 cm (7.87 x 3.17 x 0.98 in.)
Carton Lot	5 pcs
Included Accessories	4x USB Cables; 4x Audio Cables; 1x Power Adapter*

Setup > CS724KM

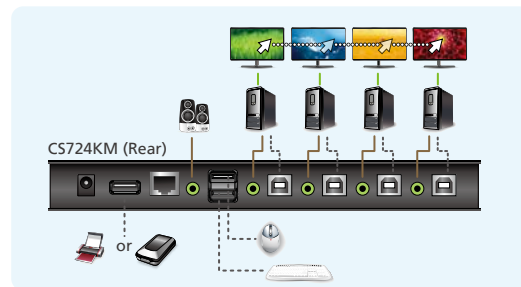
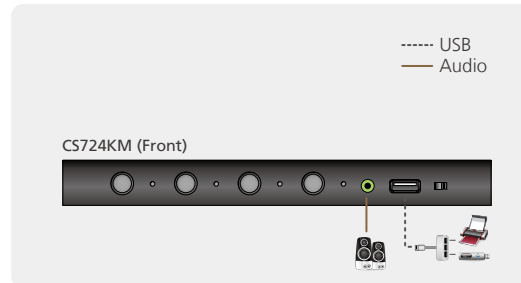

Note: * If power supply from the connected computers is insufficient, the device may need to connect to an external power adapter.

CS1953

3-Port USB-C DisplayPort KVM™ Switch

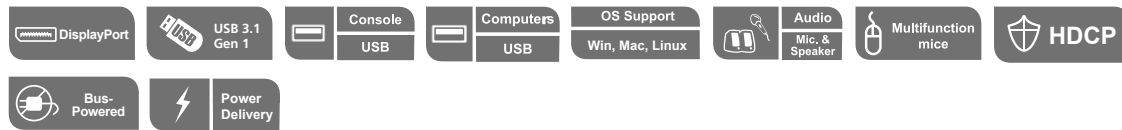

Front



Rear



Features

- One USB keyboard/mouse and DisplayPort monitor controls one computer / laptop / handset via a single USB-C cable, and two DisplayPort computers
- Fully compliant with USB-C specification – Transfers video, audio, and data via one USB-C channel
- **Compliant with USB-C power delivery 3.0 standard** – Switches the role of power provider and consumer to prevent data corruption during a sudden power cutting
- Superior video quality – up to 4K DCI (4096 x 2160 @ 60Hz)¹
- 2-Port USB 3.1 Gen 1 hub with SuperSpeed 5 Gbps data transfer rates¹
- Supports DisplayPort Alternate Mode (DP Alt Mode) to enable the USB-C connection to carry non-USB signals
- Computer selection via front panel, pushbuttons, hotkeys, mouse², and remote port selector
- USB-C specification fully compliant; HDCP compliant
- Supports HD Audio³
- Firmware upgradable; USB-Powered

Note: 1. As far as USB-C specification is concerned, if video resolution is set as 4K @ 60Hz, USB data transfer rate meets USB 2.0 standard only. In other words, if users need to use 5Gbps data transfer rates, the video resolution is up to 4K@ 30Hz. The pure DisplayPort excepted.
 2. Mouse port switching is only supported under mouse emulation mode and by USB 3-key wheel mice.
 3. HD audio through DisplayPort cannot be switched independently.

Specifications

Function	CS1953
Computer Connections	2
Port Selection	Hotkey, Pushbutton, Mouse, Remote Port Selector
Console Ports	2 x USB Type A Female 1 x DisplayPort Female (Black) 1 x 3.5mm Audio Jack Female (Green)
KVM (Computer) Ports	CPU1 and CPU2: 2 x USB 3.1 Gen 1 Type B Female (Blue) 2 x DisplayPort Female (Black) 2 x 3.5mm Audio Jack Female (Green) CPU3: 1 x USB-C Female (Black) 1 x 3.5mm Audio Jack Female (Green)
Power	1 x DC Jack
USB Hub	2 x USB 3.1 Gen 1 Type A Female (Blue; 1 x front panel; 1 x side)
Remote Port Selector	1 x 2.5mm Audio Jack Female (Black)
LEDs	
Online / Selected	2 (Orange)
Audio	2 (Green)
Video	4096 x 2160 @ 60Hz
Emulation	
Keyboard / Mouse	USB
Power Consumption	DC5V: 18.6W DC12V: 63.6W
Environmental	
Operating Temperature	0 - 50°C
Storage Temperature	-20 - 60°C
Humidity	0-80% RH, Non-condensing
Physical Properties	
Housing	Metal + Plastic
Weight	0.80 kg (1.76 lb)
Dimensions (L x W x H)	17.42 x 15.94 x 2.88 cm (6.86 x 6.28 x 1.13 in.)
Carton Lot	1 pcs
Included Accessories	1x USB-C Cable; 3x Audio Cables; 2x DisplayPort 1.2 Cables; 2x USB 3.0 Cables; 1x Remote Port Selector

CS1964

4-Port USB 3.0 4K DisplayPort Triple Display KVM™ Switch

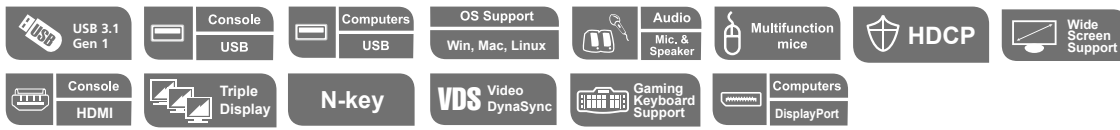

Front



Rear



Features

- One USB keyboard / mouse and Triple HDMI monitors control four DisplayPort computers
- Supports N-key Rollover (NKRO) – Permits collision-free type, a great advantage for gaming
- Supports Six Display by connecting two Triple Display KVM switches
- Superior video quality – up to 4K DCI (4096 x 2160 @ 60Hz)
- Built-in 2- Port USB 3.1 Gen 1 hub with SuperSpeed 5 Gbps data transfer rates
- Video DynaSync™ – exclusive ATEN technology eliminates boot-up display problems and optimizes the resolution when switching among different sources
- Computer selection via front panel, pushbuttons, hotkeys, mouse¹, and RS-232 Commands
- Independent switching of KVM, USB peripheral, and stereo audio
- Supports HD Audio²
- Firmware upgradable

Note: 1. Mouse port switching is only supported under mouse emulation mode and by USB 3-key wheel mice.
 2. HD audio through DisplayPort cannot be switched independently.

Specifications

Function	CS1964
Computer Connections	4
Port Selection	Hotkey, Pushbutton, Mouse, RS-232 Commands
Connectors	
Console Ports	2 x USB Type A Female 3 x HDMI Female (Black) 2 x 3.5mm Audio Jack Female (Green; 1 x front, 1 x rear) 2 x 3.5mm Audio Jack Female (Pink; 1 x front, 1 x rear)
KVM (Computer) Ports	4 x USB 3.1 Gen 1 Type B Female (Blue) 12 x DisplayPort Female (Black) 4 x 3.5mm Audio Jack Female (Green) 4 x 3.5mm Audio Jack Female (Pink)
Daisy Chain Ports	1 x RJ-45 Female
USB Hub	2 x USB 3.1 Gen 1 Type A Female (Blue; 1 x front; 1 x rear)
Power	1 x DC Jack
Video	4096 x 2160 @ 60Hz
Emulation	
Keyboard / Mouse	USB
Power Consumption	DC12V: 14.9W
Environmental	
Operating Temperature	0 – 50°C
Storage Temperature	-20 – 60°C
Humidity	0-80% RH, Non-condensing
Physical Properties	
Housing	Metal
Weight	1.93 kg (4.25 lb)
Dimensions (L x W x H)	33.50 x 15.60 x 6.55 cm (13.19 x 6.14 x 2.58 in.)
Carton Lot	3 pcs
Included Accessories	6x DisplayPort 1.2 Cables; 2x USB 3.0 Cables; 4x Audio Cables; 1x Power Adapter

CS1942DP / CS1944DP

2 / 4-Port USB 3.0 4K DisplayPort Dual Display KVM™ Switch

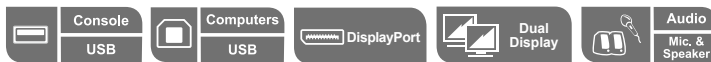

Front

• CS1942DP



• CS1944DP



Rear

• CS1942DP



• CS1944DP



Features

- One USB keyboard and mouse controls two / four DisplayPort computers and share two USB peripherals
- Supports Quad Display by connecting two Dual Display KVM switches
- Supports superior video quality – Up to 4K (4096 x 2160 / 3840 x 2160 @ 60Hz)
- Computer Selection via front panel, hotkeys, mouse, and RS-232 commands
- 2- Port USB 3.1 Gen 1 hub with SuperSpeed 5 Gbps data transfer rates
- Supports DisplayPort Dual-Mode technology (DP++)¹
- Supports Console keyboard emulation / bypass feature
- Supports Console mouse emulation / bypass feature
- Independent switching of KVM, USB, and Audio
- Multilingual keyboard mapping – supports English, French, Japanese, and German keyboards
- HDCP Compatible
- Supports HD audio²
- Power on detection
- Firmware upgradable

Note: 1. DisplayPort Dual – Mode technology (DP++) does not require an active adapter for most single display setups. Active DisplayPort adapters are recommended if you are unsure of the video source's DP++ compatibility.
2. HD audio through DisplayPort cannot be switched independently.

Specifications

Function	CS1942DP	CS1944DP
Computer Connections	2	4
Port Selection	Hotkey, Pushbutton, Mouse, RS-232 Commands	
Connectors		
Console Ports	2 x USB Type A Female 2 x DisplayPort Female (Black) 2 x 3.5 mm Audio Jack Female (Green; 1 x front, 1 x rear) 2 x 3.5 mm Audio Jack Female (Pink; 1 x front, 1 x rear)	
KVM (Computer) Ports	2 x USB 3.1 Gen 1 Type B Female (Blue) 4 x DisplayPort Female (Black) 2 x 3.5 mm Audio Jack Female (Green) 2 x 3.5 mm Audio Jack Female (Pink)	4 x USB 3.1 Gen 1 Type B Female (Blue) 8 x DisplayPort Female (Black) 4 x 3.5 mm Audio Jack Female (Green) 4 x 3.5 mm Audio Jack Female (Pink)
Daisy Chain Ports	1 x RJ-45 Female	
Power	1 x DC Jack	
USB Hub	2 x USB 3.1 Gen 1 Type A Female (Blue; 1 x front; 1 x rear)	
Emulation		
Keyboard / Mouse	USB	
Video	4096 x 2160 @ 60Hz	
Power Consumption	DC12V: 3.48W	DC12V: 5.76W
Environmental		
Operating Temperature	0 – 50°C	
Storage Temperature	-20 – 60°C	
Humidity	0-80% RH, Non-condensing	
Physical Properties		
Housing	Metal	
Weight	1.54 kg (3.40 lb)	1.51 kg (3.33 lb)
Dimensions (L x W x H)	33.50 x 15.66 x 4.40 cm (13.19 x 6.17 x 1.73 in.)	
Carton Lot	3 pcs	
Included Accessories	4x DisplayPort 1.2 Cables (Certified); 2x USB 3.0 Cables; 4x Audio Cables; 1x Power Adapter	8x DisplayPort 1.2 Cables (Certified); 4x USB 3.0 Cables; 8x Audio Cables; 1x Power Adapter

Optional Accessories

Type	Part No. / Spec.
DisplayPort to VGA Adapter*	VC925
DisplayPort to DVI Adapter*	VC965
DisplayPort to 4K HDMI Active Adapter*	VC986

Note: * For more information about the VC925, VC965, and VC986, please refer to VanCryst product catalog

CS1922M / CS1924M

2 / 4-Port USB 3.0 4K DisplayPort/Audio MST KVM™ Switch

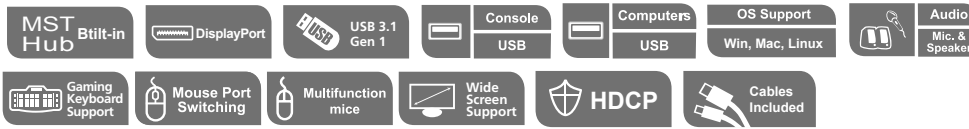

Front

- CS1922M



- CS1924M



Rear

- CS1922M



- CS1924M



► Built-in MST Hub



Enjoy the ultimate work experience: Without bulky messy cable connections, dual displays can be used via a DisplayPort and HDMI connector, making multi-tasking easier.

Features

World's First DisplayPort KVM Switch with Built-in MST Hub

- One USB keyboard/mouse and DisplayPort or HDMI monitor control 2/4 computers and share 2 USB peripherals
- Built-in Multi-Stream Transport (MST) hub allows dual displays (DisplayPort / HDMI) from a single DisplayPort source¹
- Supports MST Mode, Splitter Mode, and Single Port Mode
- 2-port USB 3.1 Gen 1 hub with SuperSpeed 5 Gbps data transfer speeds
- DisplayPort Dual-Mode (DP++) technology supports HDMI and DVI signals via a DisplayPort-to-HDMI/DVI DP++ adapter²
- Firmware upgradeable
- Hot pluggable – add or remove computers without powering down the switch

Remarkable Audio/Video Experience

- Superior video quality – 4K UHD (3840 x 2160 @ 60Hz) and 4K DCI (4096 x 2160 @ 60Hz)
- DisplayPort 1.2 compliant, HDCP compliant
- Supports HD audio through DisplayPort³
- Full bass response for high-quality 2.1 channel surround sound systems

Intelligent Operation

- Computer selection via front panel pushbuttons, hotkeys, mouse⁴, and RS-232 commands
- Independent switching of KVM, USB hub, and Audio focus
- Power On Detection – if a computer is powered off, the CS1922M / CS1924M automatically switches to the next powered-on computer
- Auto Scan Mode for monitoring all computers

Versatile Compatibility

- Keyboard emulation/bypass feature supports most gaming keyboards
- Mouse emulation/bypass feature supports most mouse drivers and multifunction mice
- Multi-platform support – Windows, Mac and Linux
- Multilingual keyboard mapping supports English, Japanese, French and German keyboards

- Note: 1. The PC source must be DisplayPort 1.2 compliant.
2. DisplayPort Dual-Mode technology (DP++) does not require an active adapter for most single display setups. Active DisplayPort adapters are recommended if you are unsure of the video source's DP++ compatibility.
3. HD audio through DisplayPort cannot be switched independently.
4. Mouse port switching is only supported under mouse emulation mode with a USB 3-button mouse wheel.

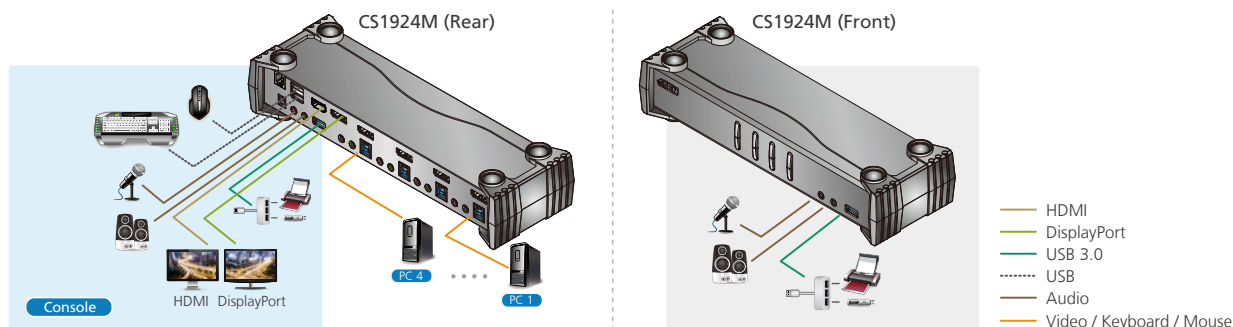

Specifications

Function	CS1922M	CS1924M
Computer Connections	2	4
Port Selection	Hotkey, Pushbutton, Mouse, RS-232 Commands	
Connectors		
Console Ports	2 x USB Type A Female 1 x DisplayPort Female (Black) 1 x HDMI Female (Black) 2 x 3.5 mm Audio Jack Female (Green; 1 x front, 1 x rear) 2 x 3.5 mm Audio Jack Female (Pink; 1 x front, 1 x rear) 1 x RJ-11 Female	
KVM (Computer) Ports	2 x USB 3.1 Gen 1 Type B Female (Blue) 2 x DisplayPort Female (Black) 2 x 3.5 mm Audio Jack Female (Green) 2 x 3.5 mm Audio Jack Female (Pink)	4 x USB 3.1 Gen 1 Type B Female (Blue) 4 x DisplayPort Female (Black) 4 x 3.5 mm Audio Jack Female (Green) 4 x 3.5 mm Audio Jack Female (Pink)
Power	1 x DC Jack	
USB Hub	2 x USB 3.1 Gen 1 Type A Female (Blue; 1 x front panel; 1 x rear panel)	
LEDs		
On Line / Selected	2 (Orange)	4 (Orange)
USB Link	2 (Green)	4 (Green)
Video	4096 x 2160 @ 60Hz	
Emulation		
Keyboard / Mouse	USB	
Power Consumption	DC5V: 3.44W	DC5V: 4.89W
Environmental		
Operating Temperature	0 – 50°C	
Storage Temperature	-20 – 60°C	
Humidity	0 – 80% RH, Non-condensing	
Physical Properties		
Housing	Metal + Plastic	
Weight	0.73 kg (1.61 lb)	0.92 kg (2.03 lb)
Dimensions (L x W x H)	21.00 x 8.80 x 5.55 cm (8.27 x 3.46 x 2.19 in.)	27.00 x 8.80 x 5.55 cm (10.63 x 3.46 x 2.19 in.)
Carton Lot	5 pcs	
Included Accessories	2x DisplayPort 1.2 Cables (Certified); 2x USB 3.0 Cables; 4x Audio Cables; 1x Power Adapter	4x DisplayPort 1.2 Cables (Certified); 4x USB 3.0 Cables; 8x Audio Cables; 1x Power Adapter

CS1922 / CS1924

2 / 4-Port USB 3.0 4K DisplayPort/Audio KVM™ Switch



Front

- CS1922



- CS1924



Rear

- CS1922



- CS1924



Features

- 2/4-port DisplayPort KVM Switch with USB 3.1 Gen 1 hub and 2.1 surround sound audio
- One USB console controls two/four computers and two USB peripherals
- Computer selection via front panel pushbuttons, hotkeys and mouse¹
- Superior video quality – 4K UHD (3840 x 2160 @ 60Hz) and 4K DCI (4096 x 2160 @ 60Hz)
- 2-port USB 3.1 Gen 1 hub with SuperSpeed 5 Gbps data transfer rates
- DisplayPort 1.2 compliant, HDCP compliant
- Supports HD audio through DisplayPort²
- Independent switching of KVM, USB, and Audio focus
- Full bass response for high-quality 2.1 channel surround sound systems
- Power On Detection – if a computer is powered off, the CS1922 / CS1924 automatically switches to the next powered-on computer
- Supports Multi-Stream Transport (MST) allows multiple monitors through a single DisplayPort connector³
- DisplayPort Dual-Mode technology (DP++) supports HDMI and DVI signals via a DisplayPort-to-HDMI/DVI DP++ adapter⁴
- Hot pluggable – add or remove computers without powering down the switch
- Mouse emulation/bypass feature supports most mouse drivers and multifunction mice
- Keyboard emulation/bypass feature supports most gaming keyboards
- Multi-platform support – Windows, Mac, and Linux
- Multilingual keyboard mapping supports English, Japanese, French and German keyboards
- Mac keyboard support and emulation⁵
- Auto Scan Mode for monitoring all computers
- Firmware upgradable

- Note: 1. Mouse port switching is only supported under mouse emulation mode with a USB 3-button mouse wheel.
2. HD audio through DisplayPort cannot be switched independently.
3. MST (Multi-Stream Transport) requires either monitors that are capable of DisplayPort 1.2 daisy-chaining, or use of a powered DisplayPort MST Hub. A DisplayPort v1.1a display can be the last display in a DisplayPort v1.2 chain. The PC source must be DisplayPort 1.2 compliant.
4. DisplayPort Dual-Mode technology (DP++) does not require an active adapter for most single display setups. Active DisplayPort adapters are recommended if you are unsure of the video source's DP++ compatibility.
5. PC keyboard combinations emulate Mac keyboards. Mac keyboards only work with their own operating system.

► 4K (4096 x 2160 @ 60Hz)

The CS1922 / CS1924 supports video at four times the quality of traditional full HD. Together with high definition audio support, the CS1922 / CS1924 guarantees a flawless media experience.

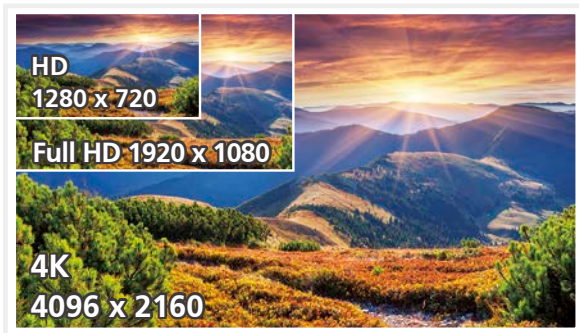

► Extreme Transmission Speed

With a built-in USB 3.0 (USB 3.1 Gen 1) hub, each computer has SuperSpeed 5 Gbps transfer rates to all connected peripherals.



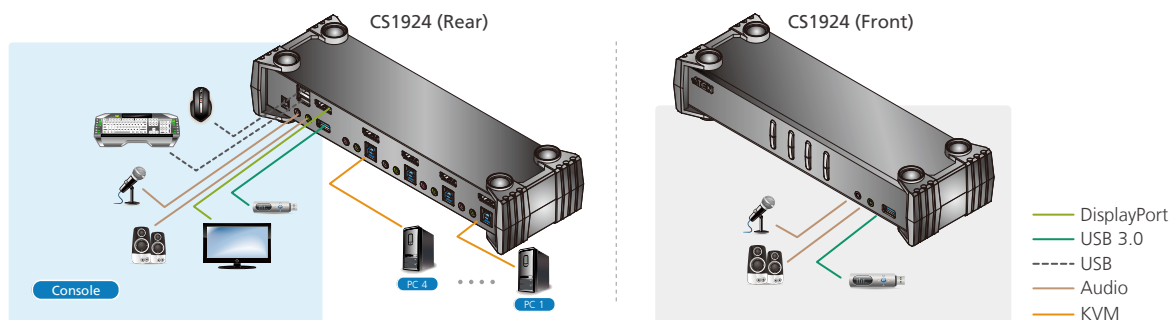

Specifications

Function	CS1922	CS1924
Computer Connections	2	4
Port Selection	Hotkey, Pushbutton, Mouse	
Connectors		
Console Ports	2 x USB Type A Female 1 x DisplayPort Female (Black) 2 x 3.5 mm Audio Jack Female (Green; 1 x front, 1 x rear) 2 x 3.5 mm Audio Jack Female (Pink; 1 x front, 1 x rear)	
KVM (Computer) Ports	2 x USB 3.1 Gen 1 Type B Female (Blue) 2 x DisplayPort Female (Black) 2 x 3.5 mm Audio Jack Female (Green) 2 x 3.5 mm Audio Jack Female (Pink)	4 x USB 3.1 Gen 1 Type B Female (Blue) 4 x DisplayPort Female (Black) 4 x 3.5 mm Audio Jack Female (Green) 4 x 3.5 mm Audio Jack Female (Pink)
Power	1 x DC Jack	
USB Hub	2 x USB 3.1 Gen 1 Type A Female (Blue; 1 x front panel; 1 x rear panel)	
Emulation		
Keyboard / Mouse	USB	
Video	4096 x 2160 @ 60Hz	
LEDs		
On Line / Selected	2 (Orange)	4 (Orange)
USB Link	2 (Green)	4 (Green)
Power Consumption	DC5V: 1.15W	DC5V: 2.33W
Environmental		
Operating Temperature	0 – 50°C	
Storage Temperature	-20 – 60°C	
Humidity	0 – 80% RH, Non-condensing	
Physical Properties		
Housing	Metal + Plastic	
Weight	0.73 kg (1.61 lb)	0.91 kg (2 lb)
Dimensions (L x W x H)	21.00 x 8.80 x 5.55 cm (8.27 x 3.46 x 2.19 in.)	27.00 x 8.80 x 5.55 cm (10.63 x 3.46 x 2.19 in.)
Carton Lot	5 pcs	
Included Accessories	2x DisplayPort 1.2 Cables (Certified); 2x USB 3.0 Cables; 4x Audio Cables; 1x Power Adapter	4x DisplayPort 1.2 Cables (Certified); 4x USB 3.0 Cables; 8x Audio Cables; 1x Power Adapter

CS1912 / CS1914

2 / 4-Port USB 3.0 DisplayPort/Audio KVM™ Switch



7

Desktop KVM Switches

Front

• CS1912



• CS1914



Rear

• CS1922



• CS1924



Features

- One USB console controls two/four computers and two USB peripherals
- Computer selection via front panel pushbuttons, hotkeys and mouse¹
- Superior video resolution – up to 4K (3840 x 2160 @ 30Hz)
- 2-port USB 3.1 Gen 1 hub with SuperSpeed 5 Gbps data transfer rates
- DisplayPort 1.1 compliant; HDCP compliant
- Supports HD audio through DisplayPort²
- Full bass response for high-quality 2.1 channel surround sound systems
- Power On Detection – if a computer is powered off, the CS1912 / CS1914 automatically switches to the next powered-on computer
- DisplayPort Dual-Mode technology (DP++) supports HDMI and DVI signals via a DisplayPort-to-HDMI/DVI DP++ adapter³
- Mouse emulation/bypass feature supports most mouse drivers and multifunction mice
- Keyboard emulation/bypass feature supports most gaming keyboards
- Multilingual keyboard mapping supports English, Japanese, French and German keyboards
- Mac keyboard support and emulation⁴

Note: 1. Mouse port switching is only supported under mouse emulation mode with a USB 3-button mouse wheel.
2. HD audio through DisplayPort cannot be switched independently.
3. DisplayPort Dual-Mode technology (DP++) does not require an active adapter for most single display setups. Active DisplayPort adapters are recommended if you are unsure of the video source's DP++ compatibility.
4. PC keyboard combinations emulate Mac keyboards. Mac keyboards only work with their own operating system.

Specifications

Function	CS1912	CS1914
Computer Connections	2	4
Port Selection	Hotkey, Pushbutton, Mouse	
Connectors		
Console Ports	2 x USB Type A Female (Black) 1 x DisplayPort Female (Black) 2 x 3.5 mm Audio Jack Female (Green; 1 x front, 1 x rear)	
KVM (Computer) Ports	2 x USB 3.1 Gen 1 Type B Female (Blue) 2 x DisplayPort Female (Black) 2 x 3.5 mm Audio Jack Female (Green)	4 x USB 3.1 Gen 1 Type B Female (Blue) 4 x DisplayPort Female (Black) 4 x 3.5 mm Audio Jack Female (Green)
Power	1 x DC Jack	
USB Hub	2 x USB 3.1 Gen 1 Type A Female (Blue; 1 x front panel; 1 x rear panel)	
Emulation		
Keyboard / Mouse	USB	
Video	3840 x 2160 @ 30Hz	
LEDs		
On Line / Selected	2 (Orange)	4 (Orange)
USB Link	2 (Green)	4 (Green)
Power Consumption	DC5V: 1.15W	DC5V: 2.33W
Environmental		
Operating Temperature	0 – 50°C	
Storage Temperature	-20 – 60°C	
Humidity	0 – 80% RH, Non-condensing	
Physical Properties		
Housing	Metal + Plastic	
Weight	0.73 kg (1.61 lb)	0.91 kg (2 lb)
Dimensions (L x W x H)	21.00 x 8.80 x 5.55 cm (8.27 x 3.46 x 2.19 in.)	27.00 x 8.80 x 5.55 cm (10.63 x 3.46 x 2.19 in.)
Carton Lot	5 pcs	5 pcs
Included Accessories	2x DisplayPort Cables; 2x USB 3.0 Cables; 2x Audio Cables; 1x Power Adapter	4x DisplayPort Cables; 4x USB 3.0 Cables; 4x Audio Cables; 1x Power Adapter

CS782DP

2-Port USB DisplayPort/Audio KVM Switch (4K Supported)



Computer Port 1



Computer Port 2



Console Port



Features

- One DisplayPort video console controls two USB computers
- Fully DisplayPort 1.2 Compliant
- HDCP Compliant
- Superior video quality – 4K UHD (3840 x 2160 @ 60Hz) and 4K DCI (4096 x 2160 @ 60Hz)
- Computer selection via remote port selector, hotkeys, and USB mouse¹
- Supports MST (Multi-Stream Transport)², enabling multiple monitors to be used via a single DisplayPort connector
- Supports DisplayPort Dual-Mode (DP++)³ for directly outputting single-link HDMI and / or DVI signals via a powered DisplayPort-to-HDMI / DVI DP++ adapter
- Power on detection – if either of the computers is powered off, the CS782DP will automatically switch to the other computer
- Audio-enabled – full bass response provides a rich experience for 2.1 channel surround sound systems
- Supports HD Audio⁴ through DisplayPort playback
- Independent switching of the KVM and Audio focus⁴ allows convenient multi-tasking
- Supports multimedia keyboards
- Supports wireless keyboards and mice
- Console mouse port emulation / bypass feature supports most mouse drivers and multifunction mice
- Mac / Sun keyboard support and emulation⁵
- USB 2.0 mouse port can be used for USB hub and USB peripheral sharing⁶ (this may require an extra powered USB Hub)
- Bus powered – No external power adapter required

- Note: 1. Mouse port switching is only supported under mouse emulation mode and by USB 3-key wheel mice.
2. MST (Multi-Stream Transport) requires either monitors that are capable of DisplayPort 1.2 daisy chaining, or use of an externally powered DisplayPort MST Hub. The PC source must be DisplayPort 1.2 compliant.
3. DisplayPort Dual - Mode (DP++) requires the use of a powered DP++ adapter. The graphics source must be DP++ compliant.
4. HD audio through DisplayPort interface cannot be switched independently.
5. (1) PC keyboard combinations emulate Mac / Sun keyboards.
(2) Mac / Sun keyboards work only with their own computers.
6. This feature may require an extra power adapter connected to the USB hub and the CS782DP's Mouse Emulation Mode should be disabled.

Specifications

Function	CS782DP
Computer Connections	2
Port Selection	Hotkey, Mouse, Remote Port Selector
Connectors	
Console Ports	2 x USB Type A Female 1 x DisplayPort Female (Black) 1 x 3.5 mm Audio Jack Female (Green)
KVM Ports	2 x USB Type B Female 2 x DisplayPort Female (Black) 2 x 3.5 mm Audio Jack Female (Green)
Remote Port Selector	1 x 2.5 mm Audio Jack Female
Emulation	
Keyboard / Mouse	USB
Video	4096 x 2160 @ 60Hz
LEDs	
KVM	2 (White)
Power Consumption	DC5V: 2.18W
Environmental	
Operating Temperature	0 – 50°C
Storage Temperature	-20 – 60°C
Humidity	0 – 80% RH, Non-condensing
Physical Properties	
Housing	Plastic
Weight	0.12 kg (0.26 lb)
Dimensions (L x W x H)	9.37 x 9.30 x 2.68 cm (3.69 x 3.66 x 1.06 in.)
Carton Lot	10 pcs
Included Accessories	2x DisplayPort 1.2 Cables (Certified); 2x USB Cables; 2x Audio Cables; 1x Remote Port Selector

CS1822 / CS1824

2/4-Port USB 3.0 4K HDMI KVMP™ Switch with Audio Mixer

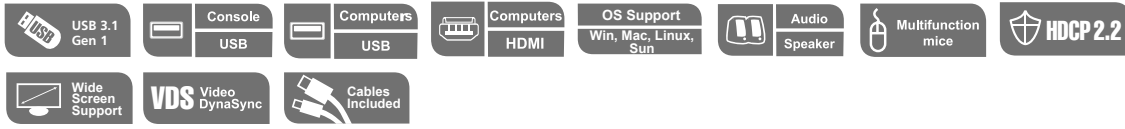

7

Desktop KVM Switches

Front

- CS1822



- CS1824



Rear

- CS1822



- CS1824



Features

- One USB keyboard / mouse and HDMI monitor control two / four computers and shares USB peripherals
- **Audio mixer** – To avoid missing any system alert, when controlling one computer, users are allowed to receive the audio message from the other computer
- Supports True 4K video resolution – up to 4K DCI (4096 x 2160 @ 60Hz; YCbCr 4:4:4)
- 2- Port USB 3.1 Gen 1 hub with SuperSpeed 5 Gbps data transfer rates
- **Video DynaSync™** – exclusive ATEN technology eliminates boot-up display problems and optimizes the resolution when switching among different sources
- Computer selection via front panel, pushbuttons, hotkeys, mouse¹, RS-232 commands
- HDMI 2.0 compliant; HDCP 2.2 compliant
- Supports HD Audio²
- Multilingual keyboard mapping – supports English, French, Japanese, and German keyboards
- Firmware upgradable

Note: 1. Mouse port switching is only supported under mouse emulation mode and by USB 3-key wheel mice.
2. HD audio through HDMI cannot be switched independently.

Specifications

Function	CS1822	CS1824
Computer Connections	2	4
Port Selection	Hotkey, Pushbutton, Mouse, RS-232 Commands	
Connectors		
Console Ports	2 x USB Type A Female; 1 x HDMI Female (Black); 2 x 3.5mm Audio Jack Female (Green; 1 x front, 1 x rear)	
KVM (Computer) Ports	2 x USB 3.1 Gen 1 Type B Female (Blue) 2 x HDMI Female (Black) 2 x 3.5mm Audio Jack Female (Green)	4 x USB 3.1 Gen 1 Type B Female (Blue) 4 x HDMI Female (Black) 4 x 3.5mm Audio Jack Female (Green)
Power	1 x DC Jack	
USB Hub	2 x USB 3.1 Gen 1 Type A Female (Blue; 1 x front panel; 1 x rear panel)	
LEDs		
On Line /Selected	2 (Orange)	4 (Orange)
USB Link	2 (Green)	4 (Green)
Audio	2 (Green)	4 (Green)
Emulation		
Keyboard / Mouse	USB	
Video	4096 x 2160 @ 60Hz	
Environmental		
Operating Temperature	0 - 50°C	
Storage Temperature	-20 - 60°C	
Humidity	0-80% RH, Non-condensing	
Physical Properties		
Housing	Metal + Plastic	
Weight	0.73 kg (1.61 lb)	0.91 kg (2 lb)
Dimensions (L x W x H)	21.00 x 8.80 x 5.55 cm (8.27 x 3.46 x 2.19 in.)	27.00 x 8.80 x 5.55 cm (10.63 x 3.46 x 2.19 in.)
Included Accessories	2x HDMI2.0 Cables; 2x USB 3.1 Gen 1 Type A to B Cables; 2x Audio Cables; 1x Power Cord	4x HDMI2.0 Cables; 4x USB 3.1 Gen 1 Type A to B Cables; 4x Audio Cables; 1x Power Cord

CS1792 / CS1794

2 / 4-Port USB HDMI/Audio KVM™ Switch



Front

• CS1792



• CS1794



Rear

• CS1792



• CS1794



Features

- One USB console controls two / four USB HDMI computers
- Dolby True HD and DTS HD Master Audio support*
- [Video DynaSync™ – exclusive ATEN technology eliminates boot-up display problems and optimizes the resolution when switching between ports](#)
- HDCP compatible
- Audio enabled – full bass response provides a rich experience for 2.1 channel surround sound systems
- Superior video quality – supports 480i, 480p, 720p, 1080i and 1080p (HDTV) / 1920 x 1200 (DVI)
- Console mouse port emulation / bypass feature supports most mouse drivers and multifunction mice
- Power on detection – if one of the computers is powered off, the switch will automatically switch to the next powered-on computer
- Supports keyboard combinations via emulation (for Mac)

Note: * HD audio through HDMI interface

Specifications

Function	CS1792	CS1794
Computer Connections	2	4
Port Selection	Hotkey, Pushbutton	
Connectors		
Console Ports	2 x USB Type A Female (rear panel); 1 x HDMI Female (Black); 2 x 3.5 mm Audio Jack Female (Green; 1 x front, 1 x rear); 2 x 3.5 mm Audio Jack Female (Pink; 1 x front, 1 x rear)	
KVM Ports	2 x USB Type B Female 2 x HDMI Female (Black) 2 x 3.5 mm Audio Jack Female (Green) 2 x 3.5 mm Audio Jack Female (Pink)	4 x USB Type B Female 4 x HDMI Female (Black) 4 x 3.5 mm Audio Jack Female (Green) 4 x 3.5 mm Audio Jack Female (Pink)
Firmware Upgrade	1 x 3.5 mm Audio Jack Female (Black)	
Power	1 x DC Jack	
USB Hub	2 x USB Type A Female (1 x front panel; 1 x rear panel)	
Emulation		
Keyboard / Mouse	USB	
Video	1920 x 1080 @ 60Hz / 1920 x 1200 @ 60Hz	
LEDs		
Audio	3 (Green)	5 (Green)
KVM	3 (Orange)	5 (Orange)
USB	3 (Green)	5 (Green)
Power Consumption	DC5.3V: 5.35W	DC5.3V: 3.62W
Environmental		
Operating Temperature	0 – 50°C	
Storage Temperature	-20 – 60°C	
Humidity	0 – 80% RH, Non-condensing	
Physical Properties		
Housing	Metal + Plastic	
Weight	0.42 kg (0.93 lb)	0.53 kg (1.17 lb)
Dimensions (L x W x H)	20.63 x 7.24 x 4.40 cm (8.12 x 2.85 x 1.73 in.)	26.23 x 7.68 x 4.40 cm (10.33 x 3.02 x 1.73 in.)
Carton Lot	5 pcs	
Included Accessories	2x USB HDMI KVM Cables; 1x Firmware Upgrade Cable; 1x Power Adapter	4x USB HDMI KVM Cables; 1x Firmware Upgrade Cable; 1x Power Adapter

Optional Accessories

Type	Part No. / Spec.	Page No.
HDMI KVM Cable	2L-7D02UH (1.8 m)	12-3 T

CS1642A / CS1644A

2 / 4-Port USB DVI Dual Link Dual Display/Audio KVM™ Switch

Dual Link

Supports Quad Display with 2 Dual Display KVM Switches



Front

• CS1642A



• CS1644A



Rear

• CS1642A



• CS1644A



Features

- Supports Quad Display by connecting two dual display KVM switches
- [Video DynaSync™ – exclusive ATEN technology eliminates boot-up display problems and optimizes the resolution when switching between ports](#)
- HDCP compatible
- Customizable front panel pushbuttons – set the pushbutton with your favorite hotkey command to activate any function from the front panel
- Console expansion – easily connect multiple CS1642A / CS1644A units for an extended multi-view KVM console setup with more computers
- One dual-screen USB console controls two/four computers
- Fully compliant with the DVI-Digital and DVI-Analog specification
- Audio enabled – full bass response provides a rich experience for 2.1 channel surround sound systems
- Console mouse port emulation / bypass feature supports most mouse drivers and multifunction mice
- Supports keyboard combinations via emulation (for Mac / Sun)

Specifications

Function	CS1642A	CS1644A
Computer Connections	2	4
Port Selection	Hotkey, Pushbutton, Mouse	
Connectors		
Console Ports	2 x USB Type A Female (rear panel) 2 x DVI-I Female (White) 1 x 3.5 mm Audio Jack Female (Green) 1 x 3.5 mm Audio Jack Female (Pink)	
KVM Ports	2 x USB Type B Female 4 x DVI-I Female (White) 2 x 3.5 mm Audio Jack Female (Green) 2 x 3.5 mm Audio Jack Female (Pink)	4 x USB Type B Female 8 x DVI-I Female (White) 4 x 3.5 mm Audio Jack Female (Green) 4 x 3.5 mm Audio Jack Female (Pink)
Daisy Chain Ports	1 x RJ-45 Female (rear panel)	
Power	1 x DC Jack	
USB Hub	2 x USB Type A Female (1 x front panel; 1 x rear panel)	
Emulation		
Keyboard / Mouse	USB	
Video	DVI Dual Link: 2560 x 1600 @ 60Hz; 3D Display: 1920 x 1200 @ 120Hz	
Power Consumption	DC5.3V: 3.77W	DC5.3V: 5.34W
Environmental		
Operating Temperature	0 – 50°C	
Storage Temperature	-20 – 60°C	
Humidity	0 – 80% RH, Non-condensing	
Physical Properties		
Housing	Plastic + Metal	
Weight	0.56 kg (1.23 lb)	2.32 kg (5.11 lb)
Dimensions (L x W x H)	26.23 x 7.68 x 4.40 cm (10.33 x 3.02 x 1.73 in.)	43.72 x 15.98 x 4.40 cm (17.21 x 6.29 x 1.73 in.)
Carton Lot	5 pcs	
Included Accessories	2x USB DVI-D Dual Link KVM Cables; 2x DVI-D Dual Link Cables; 1x Power Adapter	4x USB DVI-D Dual Link KVM Cables; 4x DVI-D Dual Link Cables; 1x Power Adapter

Optional Accessories

Type	Part No. / Spec.	Page No.
USB DVI-D Single Link KVM Cables	2L-7D02U (1.8 m), 2L-7D03U (3 m), 2L-7D05U (5 m)	12-3 O
USB DVI-I Single Link KVM Cable	2L-7D02UI (1.8 m), 2L-7D03UI (3 m)	12-3 O
USB DVI Dual Link KVM Cables	2L-7D02UD (1.8 m), 2L-7D03UD (3 m), 2L-7D05UD (5 m)	12-3 P
DVI-D Dual Link Cables	2L-7D02DD (1.8 m), 2L-7D03DD (3 m), 2L-7D05DD (5 m)	12-3 Q

CS1782A / CS1784A

2 / 4-Port USB DVI Dual Link/Audio KVM™ Switch

Dual Link DVI & 7.1* Surround Sound USB KVM™ Switch

Dual Link



(CS1784A)

(*CS1782A only)

Front

- CS1782A



- CS1784A



Rear

- CS1782A



- CS1784A



Features

- DVI digital and analog monitor support – fully compliant with the DVI specifications
- [Video DynaSync™ – exclusive ATEN technology eliminates boot-up display problems and optimizes the resolution when switching between ports](#)
- Full bass response for high quality 2.1 channel (CS1784A) / 7.1 channel surround sound systems (CS1782A)
- Superior video quality: 1920 x 1200 @ 60Hz (Single Link); 2560 x 1600 @ 60Hz (Dual Link): Works with cutting edge 120Hz LCD monitors and active shutter glasses to create a 3D environment with maximum resolution of up to 1920 x 1080 for your ideal workspace and entertainment
- 2 / 4-port DVI KVM Switch with USB 2.0 and 7.1 / 2.1 surround sound audio
- HDCP compatible
- Power on detection – if one of the computers is powered off, the switch will automatically switch to the next powered-on computer
- Console mouse port emulation / bypass feature that supports most mouse drivers and multifunction mice
- Console keyboard emulation / bypass feature that supports most gaming / multimedia keyboards
- Multilingual keyboard mapping – supports English, French and Japanese keyboards
- Supports keyboard combinations via emulation (for Mac / Sun)

Specifications

Function	CS1782A	CS1784A
Computer Connections	2	4
Port Selection	Hotkey, Pushbutton, Mouse	
Connectors		
Console Ports	2 x USB Type A Female (rear panel) 1 x DVI-I Female (White) 1 x USB Type A Female (rear panel) 2 x 3.5 mm Audio Jack Female (Green; 1 x front panel, 1 x rear panel) 1 x 3.5 mm Audio Jack Female (Blue) 1 x 3.5 mm Audio Jack Female (Gray) 1 x 3.5 mm Audio Jack Female (Black) 1 x 3.5 mm Audio Jack Female (Orange) 2 x 3.5 mm Audio Jack Female (Pink; 1 x front panel, 1 x rear panel)	2 x USB Type A Female (rear panel) 1 x DVI-I Female (White) 1 x USB Type A Female (Black; rear panel) 2 x 3.5 mm Audio Jack Female (Green; 1 x front panel, 1 x rear panel) 2 x 3.5 mm Audio Jack Female (Pink; 1 x front panel, 1 x rear panel)
KVM Ports	2 x USB Type B Female 2 x DVI-I Female (White) 2 x 3.5 mm Audio Jack Female (Green) 2 x 3.5 mm Audio Jack Female (Blue) 2 x 3.5 mm Audio Jack Female (Gray) 2 x 3.5 mm Audio Jack Female (Black) 2 x 3.5 mm Audio Jack Female (Orange) 2 x 3.5 mm Audio Jack Female (Pink)	4 x USB Type B Female 4 x DVI-I Female (White) 4 x 3.5 mm Audio Jack Female (Green) 4 x 3.5 mm Audio Jack Female (Pink)
Power	1 x DC Jack	
USB Hub	2 x USB Type A Female (1 x front panel, 1 x rear panel)	
Emulation		
Keyboard / Mouse	USB	
Video	DVI Single Link: 1920 x 1200 @ 60Hz; DVI Dual Link: 2560 x 1600 @ 60Hz	
Power Consumption	DC5.3V: 3.3W	DC5.3V: 5.91W
Environmental		
Operating Temperature	0 – 50°C	
Storage Temperature	-20 – 60°C	
Humidity	0 – 80% RH, Non-condensing	
Physical Properties		
Housing	Metal	
Weight	0.90 kg (1.98 lb)	0.93 kg (2.05 lb)
Dimensions (L x W x H)	27.00 x 8.80 x 5.55 cm (10.63 x 3.46 x 2.19 in.)	
Carton Lot	5 pcs	
Included Accessories*	2x USB DVI-D Dual Link KVM Cables; 2x Custom 7.1 Channel Surround Sound Cables; 1x Power Adapter	4x USB DVI-D Dual Link KVM Cables; 1x Power Adapter

Note: * 1. Custom KVM Cable: 1.8 m x 2 (CS1782A); 1.8 m x 4 (CS1784A)
 2. Channel Surround Sound Cable: 1.8 m x 2 (CS1782A)

Optional Accessories

Type	Part No. / Spec.	Page No.
USB DVI-D Single Link KVM Cables	2L-7D02U (1.8 m), 2L-7D03U (3 m), 2L-7D05U (5 m)	12-3 O
USB DVI-I Single Link KVM Cable	2L-7D02UI (1.8 m), 2L-7D03UI (3 m)	12-3 O
USB DVI-D Dual Link KVM Cables	2L-7D02UD (1.8 m), 2L-7D03UD (3 m), 2L-7D05UD (5 m)	12-3 P

CS1762A / CS1764A

2 / 4-Port USB DVI/Audio KVMP™ Switch

Control 2 / 4 DVI Computers from a single USB / DVI Console



Front

- CS1762A



- CS1764A



Rear

- CS1762A

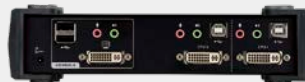

- CS1764A



Features

- Fully compliant with the DVI-D and DVI-A specifications
- [Video DynaSync™ – exclusive ATEN technology eliminates boot-up display problems and optimizes the resolution when switching between ports](#)
- HDCP compatible
- One USB console controls two/four DVI computers
- Audio enabled – full bass response provides a rich experience for 2.1 channel surround sound systems
- Console mouse port emulation / bypass feature supports most mouse drivers and multifunction mice
- Power on detection – if one computer is powered off, the CS1762A / CS1764A will automatically switch to the next powered-on computer
- Multilingual keyboard mapping – supports English, French and Japanese keyboards
- Supports keyboard combinations via emulation (for Mac / Sun)

Specifications

Function	CS1762A	CS1764A
Computer Connections	2	4
Port Selection	Hotkey, Pushbutton, Mouse	
Connectors		
Console Ports	2 x USB Type A Female 1 x DVI-I Female (White) 1 x 3.5 mm Audio Jack Female (Green; rear panel) 1 x 3.5 mm Audio Jack Female (Pink; rear panel)	
KVM Ports	2 x USB Type B Female 2 x DVI-I Female (White) 2 x 3.5 mm Audio Jack Female (Green) 2 x 3.5 mm Audio Jack Female (Pink)	4 x USB Type B Female 4 x DVI-I Female (White) 4 x 3.5 mm Audio Jack Female (Green) 4 x 3.5 mm Audio Jack Female (Pink)
Power	1 x DC Jack	
USB Hub	2 x USB Type A Female (rear panel)	2 x USB Type A Female (1 x front panel, 1 x rear panel)
Emulation		
Keyboard / Mouse	USB	
Video	1920 x 1200 @ 60Hz; DDC2B	
LEDs		
On Line / Selected	2 (Orange)	4 (Orange)
USB Link	2 (Green)	4 (Green)
Power Consumption	DC5.3V: 3.78W	DC5.3V: 10.7W
Environmental		
Operating Temperature	0 – 50°C	
Storage Temperature	-20 – 60°C	
Humidity	0 – 80% RH, Non-condensing	
Physical Properties		
Housing	Metal	
Weight	0.73 kg (1.61 lb)	0.94 kg (2.07 lb)
Dimensions (L x W x H)	21.00 x 8.80 x 5.55 cm (8.27 x 3.46 x 2.19 in.)	27.00 x 8.80 x 5.55 cm (10.63 x 3.46 x 2.19 in.)
Carton Lot	5 pcs	
Included Accessories	2x USB DVI Single Link KVM Cables; 1x Power Adapter	4x USB DVI Single Link KVM Cables; 1x Power Adapter

Optional Accessories

Type	Part No. / Spec.	Page No.
USB DVI-D Single Link KVM Cables	2L-7D02U (1.8 m), 2L-7D03U (3 m), 2L-7D05U (5 m)	12-3 O
USB DVI-I Single Link KVM Cables	2L-7D02UI (1.8 m), 2L-7D03UI (3 m)	12-3 O

CS72D

2-Port USB DVI/Audio Slim KVM Switch



Front



Rear



Features

- Compact size with ergonomic style
- HDCP compatible
- [Video DynaSync™ – exclusive ATEN technology eliminates boot-up display problems and optimizes the resolution when switching between ports](#)
- USB 2.0 mouse port can be used as a USB hub and for USB peripheral sharing
- Fully compliant with DVI specification (digital only)
- Supports wireless mouse / keyboard
- Console mouse port emulation / bypass feature supports most mouse drivers and multi-function mice
- Audio enabled – full bass response provides a rich experience for 2.1 channel surround sound systems
- Power on detection – if one computer is powered off, the switch will automatically switch to the next powered-on computer
- Complete keyboard emulation for error-free booting
- Bus-powered – No external power adapter required
- Supports keyboard combinations via emulation (for Mac / Sun)

Specifications

Function	CS72D
Computer Connections	2
Console Connections	1
Port Selection	Hotkey, Pushbutton, Mouse
Connectors	
Console Ports	2 x USB Type A Female 1 x DVI-D Female (White) 1 x 3.5 mm Audio Jack Female (Green)
Computer Port 1	1 x 44-pin Connector Female
Pushbuttons	2
Emulation	
Keyboard / Mouse	USB
Video	1920 x 1080 @ 60Hz; 1920 x 1200 @ 60Hz
Power Consumption	DC5V: 1.67W
Environmental	
Operating Temperature	0 – 50°C
Storage Temperature	-20 – 60°C
Humidity	0 – 80% RH, Non-condensing
Physical Properties	
Housing	Metal
Weight	0.33 kg (0.73 lb)
Dimensions (L x W x H)	12.50 x 8.20 x 2.50 cm (4.92 x 3.23 x 0.98 in.)
Carton Lot	10 pcs
Included Accessories	1x 1.2 m 44-pin Custom KVM Cable

CS1742 / CS1744

2 / 4-Port USB VGA Dual Display/Audio KVM™ Switch

Dual Display (2 VGA Card PC) USB KVM Switch + Audio



Front

- CS1742



- CS1744



Rear

- CS1742



- CS1744



Features

- One dual-screen USB console controls two/four dual display computers
- Audio enabled – full bass response provides a rich experience for 2.1 channel surround sound systems
- Supports keyboard combinations via emulation (for Mac / Sun)
- Multiplatform support: compatible with all operation platforms PC – Windows, Linux, Mac and Sun
- Buzzer on/off via hotkey
- Keyboard and mouse emulation for error free booting
- Bus powered – No external power adapter required

Specifications

Function	CS1742	CS1744
Computer Connections	2	4
Port Selection	Hotkey, Pushbutton	
USB Port / Audio Port Selection	Hotkey	
Connectors		
Console Ports	2 x USB Type A Female 2 x HDB-15 Female (Blue) 1 x 3.5 mm Audio Jack Female (Green) 1 x 3.5 mm Audio Jack Female (Pink)	
KVM Ports	2 x SPHD-15 Male (Yellow) 2 x SPHD-15 Female (Green)	4 x SPHD-15 Male (Yellow) 4 x SPHD-15 Female (Green)
Firmware Upgrade	1 x RJ-11 Female (Black)	
Power	1 x DC Jack (Black)	
USB Hub	2 x USB Type A Female (White)	
Emulation		
Keyboard / Mouse	USB	
Video	2048 x 1536; DDC2B	
LEDs		
On Line / Selected	2 (Orange)	4 (Orange)
USB Link	2 (Green)	4 (Green)
Power Consumption	DC5V: 0.98W	DC5V: 1.13W
Environmental		
Operating Temperature	0 – 50°C	
Storage Temperature	-20 – 60°C	
Humidity	0 – 80% RH, Non-condensing	
Physical Properties		
Housing	Metal	
Weight	0.82 kg (1.81 lb)	1.03 kg (2.27 lb)
Dimensions (L x W x H)	21.00 x 8.80 x 5.55 cm (8.27 x 3.46 x 2.19 in.)	27.00 x 8.80 x 5.55 cm (10.63 x 3.46 x 2.19 in.)
Carton Lot	10 pcs	5 pcs
Included Accessories	2x KVM Cables (Audio / Video); 2x KVM Cables (USB / Video); 1x Firmware Upgrade Cable	4x KVM Cables (Audio / Video); 4x KVM Cables (USB / Video); 1x Firmware Upgrade Cable

Optional Accessories

Type	Part No. / Spec.	Page No.
Audio / Video KVM Cables	2L-5202A (1.8 m), 2L-5203A (3 m), 2L-5205A (5 m)	12-1 F
USB / Video KVM Cables	2L-5201U (1.2 m), 2L-5202U (1.8 m), 2L-5203U (3 m), 2L-5205U (5 m)	12-2 N
Power Adapter	DC5V, 2.6A	N/A

CS1732B / CS1734B

2 / 4-Port PS/2-USB VGA/Audio KVM™ Switch with OSD

Advanced USB 2.0 KVM™ Switch + Audio + OSD



Front



Rear



Features

- Dual Interface – supports computers with PS/2 or USB keyboards and mice configurations
- [Video DynaSync™ – exclusive ATEN technology eliminates boot-up display problems and optimizes the resolution when switching between ports](#)
- Supports multilingual OSD operation
- One USB console controls two/four computers
- Audio enabled – full bass response provides a rich experience for 2.1 surround sound systems
- Console audio ports on front panel for easy access – ideal for IP phones
- Console mouse port emulation / bypass feature supports most mouse drivers and multifunction mice
- Supports keyboard combinations via emulation (for Mac / Sun)

Specifications

Function	CS1732B	CS1734B
Computer Connections	2	4
Console Connections	Hotkey, Pushbutton, OSD, Mouse	
Connectors		
Console Ports	2 x USB Type A Female (Black) 1 x HDB-15 Female (Blue) 2 x 3.5 mm Audio Jack Female (Green) 2 x 3.5 mm Audio Jack Female (Pink)	
KVM Ports	2 x SPHD-15 Female (Yellow) 2 x 3.5 mm Audio Jack Female (Green) 2 x 3.5 mm Audio Jack Female (Pink)	4 x SPHD-15 Female (Yellow) 4 x 3.5 mm Audio Jack Female (Green) 4 x 3.5 mm Audio Jack Female (Pink)
Firmware Upgrade	1 x 4-conductor 3.5 mm Audio Jack (Black)	
Power	1 x DC Jack	
USB Hub	2 x USB Type A Female (White)	
Emulation		
Keyboard / Mouse	PS/2; USB	
Video	2048 x 1536 @ 60Hz; DDC2B	
LEDs		
Online / Selected	2 (Orange)	4 (Orange)
USB Link	2 (Green)	4 (Green)
Power Consumption	DC5.3V: 2.53W	DC5V: 1.02W
Environmental		
Operating Temperature	0 – 50°C	
Storage Temperature	-20 – 60°C	
Humidity	0 – 80% RH, Non-condensing	
Physical Properties		
Housing	Metal	
Weight	0.55 kg (1.21 lb)	0.78 kg (1.72 lb)
Dimensions (L x W x H)	14.00 x 8.80 x 5.55 cm (5.51 x 3.46 x 2.19 in.)	21.00 x 8.80 x 5.55 cm (8.27 x 3.46 x 2.19 in.)
Carton Lot	10 pcs	
Included Accessories	2x Custom KVM Cable (VGA, USB, Audio); 2x OSD/Hotkey Stickers; 1x Firmware Upgrade Cable; 1x Power Adapter	4x Custom KVM Cable (VGA, USB, Audio); 2x OSD/Hotkey Stickers; 1x Firmware Upgrade Cable; 1x Power Adapter

Optional Accessories

Type	Part No. / Spec.	Page No.
PS/2 KVM Cables	2L-5302P (1.8 m), 2L-5303P (3 m), 2L-5305P (5 m)	12-2 M
USB KVM Cables	2L-5301U (1.2m) , 2L-5302U (1.8 m), 2L-5303U (3 m), 2L-5305U (5 m)	12-2 L

CS1732A / CS1734A

2 / 4-Port PS/2-USB VGA/Audio KVMP™ Switch

All-in-one Combo Desktop KVM Switch + Audio



Front

• CS1732A



• CS1734A



Rear

• CS1732A



• CS1734A



Features

- Dual interface supports computers with PS/2 or USB keyboards and mice
- Auto PS/2 and USB interface detection
- Audio enabled - full bass response provides a rich experience for 2.1 channel surround sound systems
- One USB console controls two/four computers and additional USB devices
- Keyboard and mouse emulation for error free booting
- Buzzer on/off via hotkey
- Multiplatform support: compatible with Windows, Linux, Mac and Sun
- Bus powered – No external power adapter required

Specifications

Function	CS1732A	CS1734A
Computer Connections	2	4
Port Selection	Hotkey, Pushbutton	
USB Port / Audio Port Selection	Hotkey	
Connectors		
Console Ports	2 x USB Type A Female (White) 1 x HDB-15 Female (Black) 1 x 3.5 mm Audio Jack Female (Green) 1 x 3.5 mm Audio Jack Female (Pink)	
KVM Ports	2 x SPHD-15 Female (Yellow) 2 x 3.5 mm Audio Jack Female (Green) 2 x 3.5 mm Audio Jack Female (Pink)	4 x SPHD-15 Female (Yellow) 4 x 3.5 mm Audio Jack Female (Green) 4 x 3.5 mm Audio Jack Female (Pink)
Firmware Upgrade	1 x RJ-11 Female (Black)	
Power	1 x DC Jack	
USB Hub	2 x USB Type A Female (Black)	
Emulation		
Keyboard / Mouse	USB	
Video	2048 x 1536; DDC2B	
LEDs		
Online / Selected	2 (Orange)	4 (Orange)
USB Link	2 (Green)	4 (Green)
Power Consumption	DC5V: 0.94W	DC5V: 1.02W
Environmental		
Operating Temperature	0 – 50°C	
Storage Temperature	-20 – 60°C	
Humidity	0 – 80% RH, Non-condensing	
Physical Properties		
Housing	Metal	
Weight	0.55 kg (1.21 lb)	0.78 kg (1.72 lb)
Dimensions (L x W x H)	14.00 x 8.80 x 5.55 cm (5.51 x 3.46 x 2.19 in.)	21.00 x 8.80 x 5.55 cm (8.27 x 3.46 x 2.19 in.)
Carton Lot	10 pcs	5 pcs
Included Accessories	2x USB KVM Cables; 1x Firmware Upgrade Cable	4x USB KVM Cables; 1x Firmware Upgrade Cable

Optional Accessories

Type	Part No. / Spec.	Page No.
PS/2 KVM Cables	2L-5302P (1.8 m), 2L-5303P (3 m), 2L-5305P (5 m)	12-2 M
USB KVM Cables	2L-5301U (1.2m), 2L-5302U (1.8 m), 2L-5303U (3 m), 2L-5305U (5 m)	12-2 L
Power Adapter	DC5V, 2.6A	N/A

CS82U / CS84U

2 / 4-Port PS/2-USB VGA KVM Switch



Features

- Dual Interface - supports computers with PS/2 or USB keyboards and mice
- [Video DynaSync™ – exclusive ATEN technology eliminates boot-up display problems and optimizes the resolution when switching between ports](#)
- One USB-PS/2 VGA console controls two/four computers
- USB mouse port can be used as a USB 1.1 hub and for USB 1.1 peripheral sharing
- Console mouse port emulation / bypass feature supports most mouse drivers and multifunction mice
- Supports most gaming keyboards
- Multilingual keyboard mapping – supports English, Japanese and French keyboards
- Supports keyboard combinations via emulation (for Mac / Sun)
- Bus powered – No external power adapter required

Specifications

Function	CS82U	CS84U
Computer Connections	2	4
Port Selection	Hotkey, Pushbutton, USB Mouse	
Connectors		
Console Ports	2 x USB Type A Female 1 x 6-pin Mini-DIN Female (Purple) 1 x 6-pin Mini-DIN Female (Green) 1 x HDB-15 Female (Blue)	
KVM Ports	2 x SPHD-18 Female (Yellow)	4 x SPHD-18 Female (Yellow)
Power	1 x DC Jack	
Emulation		
Keyboard / Mouse	PS/2, USB	
Video	2048 x 1536 @ 60Hz; DDC2B	
LEDs		
Online	2 (Orange)	4 (Orange)
Selected	2 (Green)	4 (Green)
Power Consumption	DC5V: 0.72W	DC5V: 1.2W
Environmental		
Operating Temperature	0 – 50°C	
Storage Temperature	-20 – 60°C	
Humidity	0 – 80% RH, Non-condensing	
Physical Properties		
Housing	Metal	
Weight	0.54 kg (1.19 lb)	0.77 kg (1.7 lb)
Dimensions (L x W x H)	14.00 x 8.80 x 5.55 cm (5.51 x 3.46 x 2.19 in.)	21.00 x 8.80 x 5.55 cm (8.27 x 3.46 x 2.19 in.)
Carton Lot	10 pcs	5 pcs
Included Accessory	2x PS/2-USB KVM Cables	4x PS/2-USB KVM Cables

Optional Accessories

Type	Part No. / Spec.	Page No.
PS/2-USB KVM Cables	2L-5301UP (1.2 m), 2L-5302UP (1.8 m), 2L-5303UP (3 m)	12-2 G
USB KVM Cables	2L-5201U (1.2 m), 2L-5202U (1.8 m), 2L-5203U (3 m), 2L-5205U (5 m)	12-2 N
Power Adapter	DC5V, 2.6A	N/A

CS72U / CS74U

2 / 4-Port USB VGA/Audio KVM Switch



Front



Features

- One USB VGA console controls two/four computers
- Audio enabled – full bass response provides a rich experience for 2.1 channel surround sound systems
- Supports USB hot-plugging
- Bus powered – No external power adapter required

Rear



Specifications

Function	CS72U	CS74U
Computer Connections	2	4
Port Selection	Pushbutton	
Connectors		
Console Ports	2 x USB Type A Female (Black) 1 x HDB-15 Female (Blue) 1 x 3.5 mm Audio Jack Female (Pink) 1 x 3.5 mm Audio Jack Female (Green)	
KVM Ports	2 x SPHD-18 Female (Green)	4 x SPHD-18 Female (Green)
Power	1 x DC 5V Jack (Spare)	
Video	2048 x 1536 @ 60Hz; DDC2B	
LEDs		
Online	2 (Orange)	4 (Orange)
Selected	2 (Green)	4 (Green)
Power Consumption	DC5V: 0.14W	DC5V: 0.18W
Environmental		
Operating Temperature	0 – 50°C	
Storage Temperature	-20 – 60°C	
Humidity	0 – 80% RH, Non-condensing	
Physical Properties		
Housing	Metal	
Weight	0.45 kg (0.99 lb)	0.64 kg (1.41 lb)
Dimensions (L x W x H)	13.00 x 7.65 x 4.40 cm (5.12 x 3.01 x 1.73 in.)	20.00 x 7.65 x 4.40 cm (7.87 x 3.01 x 1.73 in.)
Carton Lot	10 pcs	5 pcs
Included Accessory	2x USB KVM Cables	4x USB KVM Cables

Optional Accessories

Type	Part No. / Spec.	Page No.
USB KVM Cables	2L-5201U (1.2 m), 2L-5202U (1.8 m)	12-2 N
Power Adapter	DC5V, 2.6A	N/A

CS82A / CS84A

2 / 4-Port PS/2 VGA KVM Switch



Front



Rear



Features

- One PS/2 console controls two/four computers
- Compact, sturdy, durable metal housing
- Keyboard and mouse emulation for error-free booting
- Auto Scan function to monitor computer operation
- Bus powered – No external power adapter required

Specifications

Function	CS82A	CS84A
Computer Connections	2	4
Port Selection	Hotkey, Pushbutton	
Connectors		
Console Ports	1 x HDB-15 Female (Blue) 1 x 6-pin Mini-DIN Female (Purple) 1 x 6-pin Mini-DIN Female (Green)	
KVM Ports	2 x 6-pin Mini-DIN Female (Purple) 2 x HDB-15 Male (Blue) 2 x 6-pin Mini-DIN Female (Green)	4 x 6-pin Mini-DIN Female (Purple) 4 x HDB-15 Male (Blue) 4 x 6-pin Mini-DIN Female (Green)
Power	1 x DC Jack	
Emulation		
Keyboard / Mouse	PS/2	
Video	1920 x 1440; DDC2B	
LEDs		
Online	2 (Orange)	4 (Orange)
Selected	2 (Green)	4 (Green)
Power Consumption	DC9V: 0.3W	DC9V: 0.3W
Environmental		
Operating Temperature	0 – 50°C	
Storage Temperature	-20 – 60°C	
Humidity	0 – 80% RH, Non-condensing	
Physical Properties		
Housing	Metal	
Weight	0.54 kg (1.19 lb)	0.78 kg (1.72 lb)
Dimensions (L x W x H)	14.00 x 8.80 x 5.55 cm (5.51 x 3.46 x 2.19 in.)	21.00 x 8.80 x 5.55 cm (8.27 x 3.46 x 2.19 in.)
Carton Lot	10 pcs	
Included Accessory	2x PS/2 KVM Cables	4x PS/2 KVM Cables

Optional Accessories

Type	Part No. / Spec.	Page No.
PS/2 KVM Cables	2L-1001P/C (1.8 m), 2L-1003P/C (3 m), 2L-1005P/C (5 m), 2L-1006P/C (6 m), 2L-1010P/C (10 m), 2L-1020P/C (20 m) 2L-5001P/C (1.2 m), 2L-5002P/C (1.8 m), 2L-5003P/C (3 m), 2L-5005P/C (5 m)	12-1 A
Cables & Converters for USB Interface Support	2L-5502UP (1.8 m), 2L-5503UP (3 m), 2L-5506UP (6 m) Supports Mac Keyboards Emulation: UC100KMA	12-1 B 9-3
Power Adapter	DC9V, 300mA	N/A

CS74E

4-Port PS/2 VGA Slim KVM Switch



Front



Rear



Features

- One PS/2 console controls two/four computers
- Compact, modern case for convenient attractive placement
- Custom connector layout
- Keyboard and mouse emulation for error-free booting
- Auto Scan function to monitor computer operation
- Bus powered – No external power adapter required

Specifications

Function	CS74E
Computer Connections	4
Port Selection	Hotkey, Pushbutton
Connectors	
Console Ports	1 x SPHD-15 Male (Yellow)
KVM Ports	4 x SPHD-15 Female (Yellow)
Power	1 x DC Jack
Emulation	
Keyboard / Mouse	PS/2
Video	2048 x 1536 @ 60Hz; DDC2B
LEDs	
Selected	4 (Green)
Power Consumption	DC5V: 0.39W
Environmental	
Operating Temperature	0 – 50°C
Storage Temperature	-20 – 60°C
Humidity	0 – 80% RH, Non-condensing
Physical Properties	
Housing	Metal
Weight	0.49 kg (1.08 lb)
Dimensions (L x W x H)	20.00 x 8.15 x 2.50 cm (7.87 x 3.21 x 0.98 in.)
Carton Lot	10 pcs
Included Accessories	4x PS/2 KVM Cables; 1x Console Adapter Cable

Optional Accessories

Type	Part No. / Spec.	Page No.
PS/2 KVM Cables	2L-5201P (1.2 m), 2L-5202P / 2L-5702P (1.8 m), 2L-5203P (3 m), 2L-5206P (6 m)	12-1 C 12-1 D
Cables & Converters for USB Interface Support	2L-5202UP (1.8 m), 2L-5203UP (3 m), 2L-5205UP (5 m), 2L-5206UP (6 m) Supports Mac Keyboards Emulation: UC100KMA	12-1 E 9-3
Power Adapter	DC9V, 300mA	N/A

Computer Sharing Devices

CS261

USB DVI Computer Sharing Device

Share a DVI computer with two USB consoles



ATEN Computer Sharing Devices enable two users to share the programs, files, and resources of a single computer from two separate consoles.

Features

- Single USB DVI-D computer is shared by two USB consoles
- Manual or auto console selection
- Superior video quality: Supports resolutions of 1080p, 1920 x 1200, and 4K up to 3840 x 2160 @ 30Hz¹
- [Multiple EDID modes: Selects optimum EDID settings for smooth power-up and highest quality display](#)
- Support RS-232 serial commands: For switching operation and system configuration
- On screen display informs user when system is in use
- Private mode for a privileged user
- Screensaver function
- Mac / Sun keyboard support and emulation²
- HDCP 1.4 Compatible
- No Software required

Note: 1. 4K @ 30Hz is supported when using DVI-to-HDMI cables at both the source and monitors. Please ensure that your source and monitors are 4K @ 30Hz-capable.
 2. For PC compatible computers. Mac and Sun computers must be compatible with USB connections. PC keyboard combinations emulate Mac / Sun keyboards; Mac / Sun keyboards work only with their own computers.

Specifications

Function	CS261
Computer Connections	1
Connectors	
Console Ports	2 x DVI-D Female (White) 4 x USB Type A Female 2 x 3.5 mm Audio Jack Female (Green) 2 x 3.5 mm Audio Jack Female (Pink)
KVM Ports	1 x DVI-D Female (White) 1 x USB Type B Female 1 x 3.5 mm Audio Jack Female (Green) 1 x 3.5 mm Audio Jack Female (Pink)
RS-232	1 x RJ-11 Female
Power	1 x DC Jack (Black)
Console Selection	Pushbutton, Hotkey*, RS-232 Commands Note: *Selecting the console via hotkeys only works in Manual Mode
Video	3840 x 2160 @ 30Hz
LEDs	
Selected	2 (Green)
Manual	1 (Orange)
Power Consumption	DC5V: 2.4W
Environmental	
Operating Temperature	0-50°C
Storage Temperature	-20-60°C
Humidity	0-80% RH, Non-condensing
Physical Properties	
Housing	Metal
Weight	0.72 kg (1.59 lb)
Dimensions (L x W x H)	21.00 x 8.80 x 5.55 cm (8.27 x 3.46 x 2.19 in.)
Carton Lot	5 pcs
Included Accessories	1x USB DVI-D Single Link KVM Cable; 1x Power Adapter

Optional Accessories

Type	Part No. / Spec.	Page No.
USB HDMI to DVI-D KVM Cable	2L-7D02DH (1.8 m)	12-3 S
USB DVI-D Single Link KVM Cables	2L-7D02U (1.8 m), 2L-7D03U (3 m), 2L-7D05U (5 m)	12-3 O
HDMI to DVI Adapter	2A-128G	12-4
DVI to HDMI Adapter	2A-127G	12-4

CS231

USB VGA Computer Sharing Device

Share a VGA computer with two consoles (USB, PS/2 compatible)



Front



Rear



Features

- Single computer is shared by two USB consoles
- Manual or auto console selection
- On screen display informs user when system is in use
- Private mode for a privileged user
- Screensaver function
- Supports USB and PS/2 computers
- Supports VGA and SVGA multisync monitors
- Mac keyboard support and emulation*
- No software required

Note: * For PC compatible computers. Mac computers must be compatible with USB connections. PC keyboard combinations emulate Mac keyboards; Mac keyboards work only with their own computers.

Specifications

Function	CS231
Computer Connections	1
Connectors	
Console Ports	2 x HDB-15 Female (Blue) 4 x USB Type A Female
KVM Ports	1 x SPHD-15 Female (Green)
Firmware Upgrade	1 x RJ-11 Female
Power	1 x DC Jack (Black)
Console Selection	Pushbutton, Hotkey* Note: *Selecting console via hotkey only works in Manual Mode.
Video	1920 x 1440
LEDs	
Selected	2 (Green)
Manual	1 (Orange)
Power Consumption	DC5.3V: 1.6W
Environmental	
Operating Temperature	0-50°C
Storage Temperature	-20-60°C
Humidity	0-80% RH, Non-condensing
Physical Properties	
Housing	Metal
Weight	0.56 kg (1.23 lb)
Dimensions (L x W x H)	14.00 x 8.80 x 5.55 cm (5.51 x 3.46 x 2.19 in.)
Carton Lot	10 pcs
Included Accessories	1x USB KVM Cable; 1x Firmware Upgrade Cable; 1x Power Adapter; 1x DIP Switch Sticker

Optional Accessories

Type	Part No. / Spec.	Page No.
USB KVM Cables	2L-5201U (1.2 m), 2L-5202U (1.8 m), 2L-5203U (3 m), 2L-5205U (5 m)	12-2 N
PS/2 KVM Cables	2L-5201P(1.2 m), 2L-5202P / 2L-5702P (1.8 m), 2L-5203P (3 m), 2L-5206P (6 m)	12-1 C 12-1 D
Adapters for PS/2 Console Support	PS/2 to USB Converter: UC10KVM	9-2
USB KVM Cables (with built-in PS/2 to USB Converter)	2L-5202UP (1.8 m), 2L-5203UP (3 m), 2L-5205UP (5 m), 2L-5206UP (6 m)	12-1 E

KVM Modules & Included Accessories

Converters / Emulators

ATEN provides a series of KVM switches that feature multiplatform support. In addition, we offer a host of converters to enable your PS/2 KVM switches to support USB, Sun, and Mac computers. By using ATEN converters, you eliminate the high cost and downtime associated with replacing KVM switches.

Note: The features highlighted above are not available in all products. Please refer to each product page for more details. Product information is subject to change without prior notice.



• USB Converters

For PC / Mac / Sun >

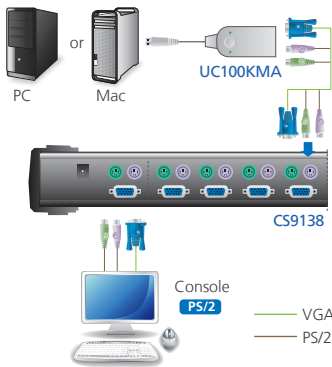

For PC only >

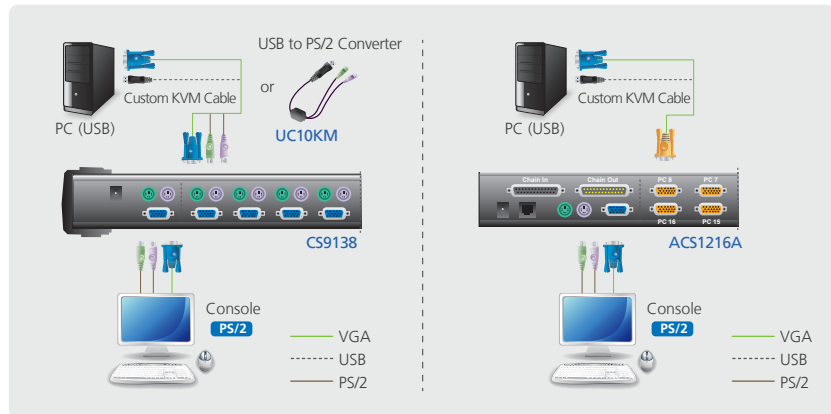

Note :

* Custom KVM cables are in various lengths. Please refer to page 12-1

CV100KM

PS/2 Emulator



Features

- Ends computer lockup due to loss of KVM focus
- Prevents computer damage from keyboard failure
- Hot-plugging of keyboard and mouse
- Keyboardless boot and run

UC10KM

PS/2 to USB Adapter (90 cm)



Features

- Two PS/2 devices (keyboard and mouse) to USB Interface converter
- Supports PS/2 and Microsoft IntelliMouse
- Compatible with KVM switches
- USB 1.1 compliant
- Easy installation – no software required
- OS Support: Windows, Linux Redhat 7.0 or higher
- Bus-Powered

Specifications

Function	CV100KM
Connectors	
Keyboard	2 x 6-pin Mini-DIN Male (Purple)
Mouse	2 x 6-pin Mini-DIN Male (Green)
LEDs	
Link	2 (Green)
Environmental	
Operating Temperature	0 – 50°C
Storage Temperature	-20 – 60°C
Humidity	0 – 80% RH, Non-condensing
Physical Properties	
Housing	Plastic
Weight	0.08 kg (0.18 lb)
Dimensions (L x W x H)	9.15 x 4.70 x 2.50 cm (3.6 x 1.85 x 0.98 in.)
Carton Lot	40 pcs

Specifications

Function	UC10KM
Connectors	
USB Port	1 x USB Type A Male (Black)
PS/2 Keyboard	1 x 6-pin Mini-DIN Female (Purple)
PS/2 Mouse	1 x 6-pin Mini-DIN Female (Green)
Cable Length	90 cm
Platforms	Windows / Linux
Data Rate	12 Mbps
USB Specification	USB 1.1 Compatible
Power Mode	Bus-Powered
Environmental	
Operating Temperature	0 – 50°C
Storage Temperature	-20 – 60°C
Humidity	0 – 80% RH, Non-condensing
Physical Properties	
Housing	Plastic
Weight	0.06 kg (0.13 lb)
Dimensions (L x W x H)	1.50 x 3.70 x 1.10 cm (0.59 x 1.46 x 0.43 in.)
Carton Lot	40 pcs

UC100KMA

PS/2 to USB Adapter with Mac support (30 cm)

OS Support
Win, Mac, Linux,
Sun, FreeBSD

Bus-Powered



Features

- Two PS/2 devices (keyboard and mouse) to USB Interface converter
- Supports PS/2 and Microsoft IntelliMouse
- Compatible with KVM switches
- USB specification compliant
- Easy installation – no software required
- Hotkey selection for OS and keyboard language supports
- OS Support: Windows 2000, Windows XP, Windows Vista, LINUX, Mac, Sun and FreeBSD
- External power adapter not required

Specifications

Function	UC100KMA
Connectors	
USB Port	1 x USB Type A Male (White)
PS/2 Keyboard	1 x 6-pin Mini-DIN Female (Purple)
PS/2 Mouse	1 x 6-pin Mini-DIN Female (Green)
LEDs	
Link	2 (Green)
Cable Length	30 cm
Platforms	Windows 2000 / XP/ Vista / Linux Mac OS 8.6 or Higher SUN Solaris 8
Data Rate	12 Mbps
Power Mode	Bus-Powered (via the USB cable)
Environmental	
Operating Temperature	0 – 50°C
Storage Temperature	-20 – 60°C
Humidity	0 – 80% RH, Non-condensing
Physical Properties	
Housing	Plastic
Weight	0.08 kg (0.18 lb)
Dimensions (L x W x H)	9.15 x 4.70 x 2.50 cm (3.6 x 1.85 x 0.98 in.)
Carton Lot	40 pcs



Thunderbolt & USB

ATEN offers a range of Thunderbolt and USB connectivity solutions to suit a wide variety of users and their applications. Our USB products give you the freedom to connect high-speed devices, such as external storage drives, optical drives, printers, and more.

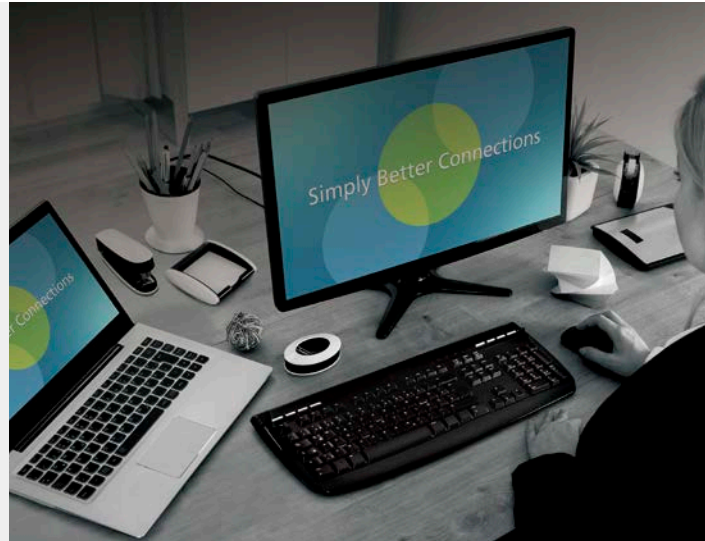

10

Thunderbolt & USB

- **Docking Stations**

Connect your laptop to a docking station and turn it into a multitasking workstation. ATEN's range of docking stations offer USB-C to Thunderbolt 3 support and expand connectivity with USB 3.1 Gen 1, HDMI, VGA, DisplayPort, Ethernet, audio, and power delivery. With these docking stations, you can spend more time working, playing and less time worrying about setup.

- **USB Converters**

ATEN USB-to-serial and USB-to-parallel converters aid in the transition to USB by allowing devices with traditional interfaces to communicate over USB interfaces. These converters help extend the useful life of your peripheral devices, thereby protecting your investment.

- **Dock Switches**

ATEN Thunderbolt and USB dock switches allow 2 computers to share the use of USB peripherals, including all necessary connectivity through a Thunderbolt / USB Type-C connection with one simple click.

- **Sharing Switches**

ATEN USB Sharing switches allow 2 to 4 computers to share the use of USB 3.1 Gen 2 / 3.1 Gen 1 / 2.0 peripheral devices on a one-at-a-time basis.

- **USB Hubs**

ATEN offers 4 port compact USB hubs for desktop and laptop computers. These are ideal for users who need to connect multiple devices, such as keyboards, mice, printers, scanners, and flash drives.

- **USB Extenders**

USB extender cables allow you to extend the distance between your computer and USB peripheral devices by several meters. These cables correct and transmit the signals as necessary to ensure optimal signal integrity. ATEN USB Extenders support USB 2.0 to USB 3.1 Gen 1 standard. They also extend the distance between your computer and USB peripheral over 100 m (UEH4112).

Note: The features highlighted above are not available in all products. Please refer to each product page for more details. Product information is subject to change without prior notice.

Feature Comparison

Type	Model No.	Max. Video resolution	Video Interface	Dual Display	USB-C PD	Power Adapter	Multiplatform Support
Docking Stations	UH3230	4096 x 2160, 3840 x 2160, 2048 x 1200, 1920 x 1080	DisplayPort, HDMI	1080p	•	•	Windows / Mac
	UH3231	3840 x 2160, 1920 x 1080	DisplayPort x 2	1080p	N/A	N/A	Windows / Mac
	UH3232	3840 x 2400, 2048x1200	HDMI, VGA	N/A	N/A	N/A	Windows / Mac
	UH3233	4096 x 2160, 3840 x 2160, 1920 x 1080	HDMI x 2	1080p	N/A	N/A	Windows / Mac
	UH3234	3840 x 2160, 1920 x 1200	DisplayPort, HDMI, VGA	1080P	•	N/A	Windows / Mac
	UH3236	3840 x 2160, 1920 x 1200	HDMI, VGA	N/A	•	N/A	Windows / Mac / Android
	UH3237	3840 x 2160, 1920 x 1200	HDMI, VGA	1080p	•	N/A	Windows / Mac
	UH7230	5160 x 2880, 4096 x 2160	DisplayPort, Thunderbolt 3	4K	•	•	Windows / Mac

Type	Model No.	Host	Upstream	Port	Downstream	Power Mode
USB Converters	UC1284B	N/A	USB 2.0	N/A	C-36 Parallel	Bus-powered
	UC2322	1	USB 2.0	2	RS-232 (DB9)	• (Optional)
	UC2324	1	USB 2.0	4	RS-232 (DB9)	• (Optional)
	UC4852	1	USB 2.0	2	RS-485 (DB9)	• (Optional)
	UC4854	1	USB 2.0	4	RS-485 (DB9)	• (Optional)
	UC3020	1	USB-C 3.1 Gen 1	1	UVC (HDMI)	Bus-powered
	UC3238	1	USB-C 3.1 Gen 1	1	HDMI	Bus-powered
	UC3008	1	USB-C 3.1 Gen 1	1	HDMI	Bus-powered
	UC3002	1	USB-C 3.1 Gen 1	1	VGA	Bus-powered
	UC232A	1	USB 2.0	1	RS-232 (DB9)	Bus-powered
	UC232B	1	USB 2.0	1	RS-232 (RJ-45)	Bus-powered
	UC231A / UC232A1	1	USB 2.0	1	RS-232 (DB9)	Bus-powered
Dock Switches	UC485	1	USB 2.0	1	RS-485 (DB9 / Terminal Block)	Bus-powered
	US7220	2	Thunderbolt 2	11	Thunderbolt 2 / HDMI / USB 3.0 / USB 2.0 / eSATA / Mini TOSLINK Line In / Out, GbE LAN Port	Self-Powered
Sharing Switches	US3310	2	USB-C 3.1 Gen 1	3	HDMI, USB 3.1 Gen 1 Type-A	• (Optional)
	US3342	2	USB-C 3.1 Gen 2	4	USB-C 3.1 Gen 2	Bus-powered
	US3324* / US234	2	USB 3.1 Gen 1	4	USB 3.1 Gen 1 Type-A	• (Optional)
	US3344* / US434	4	USB 3.1 Gen 1	4	USB 3.1 Gen 1 Type-A	• (Optional)
	US224	2	USB 2.0	4	USB 2.0 Type-A	• (Optional)
	US424	4	USB 2.0	4	USB 2.0 Type-A	• (Optional)
	US221A	2	USB 2.0	1	USB 2.0 Type-A	Bus-powered
USB Hubs	US421A	4	USB 2.0	1	USB 2.0 Type-A	Bus-powered
	UH275	1	USB 2.0	4	USB 2.0 Type-A	• (Optional)
	UH284	1	USB 2.0	4	USB 2.0 Type-A	• (Optional)

* Additional USB 3.1 Gen 1 Type-B to Type-C cable included in the US3324 / US3344 package.

Type	Model No.	Distance	Ports	Protocol	Additional Feature	Power Mode
USB Extenders	UE350A	5 m	1	USB 3.1 Gen 1	N/A	Self-Powered
	UE3310	10 m	1	USB 3.1 Gen 1	Cable Lock	Self-Powered
	UE3315	15 m	1	USB 3.1 Gen 1	Cable Lock	Self-Powered
	UE150	5 m	1	USB 2.0	N/A	Self-Powered
	UE250	5 m	1	USB 2.0	N/A	Self-Powered
	UE2120	12 m	1	USB 2.0	Cable Lock	• (Optional)
	UE2120H	12 m	4	USB 2.0	Hub	• (Optional)
	UCE3250	50 m	4	USB 2.0	Hub	Self-Powered
	UCE60	60 m	1	USB 2.0	N/A	• (Optional)
	UCE260	60 m	1	USB 2.0	N/A	Self-Powered
	UEH4002A	100 m	4	USB 2.0	Hub	Self-Powered
	UEH4102 / UEH4112	>100 m	4	USB 2.0	Hub	Self-Powered

Docking Stations



10

Thunderbolt & USB



ATEN provides a full range of docking stations that are designed to expand connectivity and create simplified and productive workspaces for any desktop environment. Whatever your desktop needs, ATEN has the best docking stations for any budget. Enjoy the stations's ergonomic design while boosting productivity and charging your laptop at the same time.

To utilize the full power of your docking station, we suggest your laptop meets the following system requirements:

Windows USB-C enabled Laptop			Multiplatform Support
<ol style="list-style-type: none"> 1. Windows® 10 (32-bit / 64-bit) and above. 2. Intel 7th-Generation Core Processor and above. 3. For video output to work through a USB-C port, it must support DP Alt Mode. To identify the right products, look for the below logos. 			<ol style="list-style-type: none"> 1. MacBook 2015 and later 2. MacBook Pro 2016 and later 3. Mac OS X 10.12 and above
<ul style="list-style-type: none"> • SuperSpeed USB Trident Logo + DisplayPort Logo 	<ul style="list-style-type: none"> • SuperSpeed USB Power Delivery Trident Logo + DisplayPort Logo 	<ul style="list-style-type: none"> • SuperSpeed USB 10 Gbps Power Delivery Trident Logo + DisplayPort Logo 	
			

Docking Station Selection Map

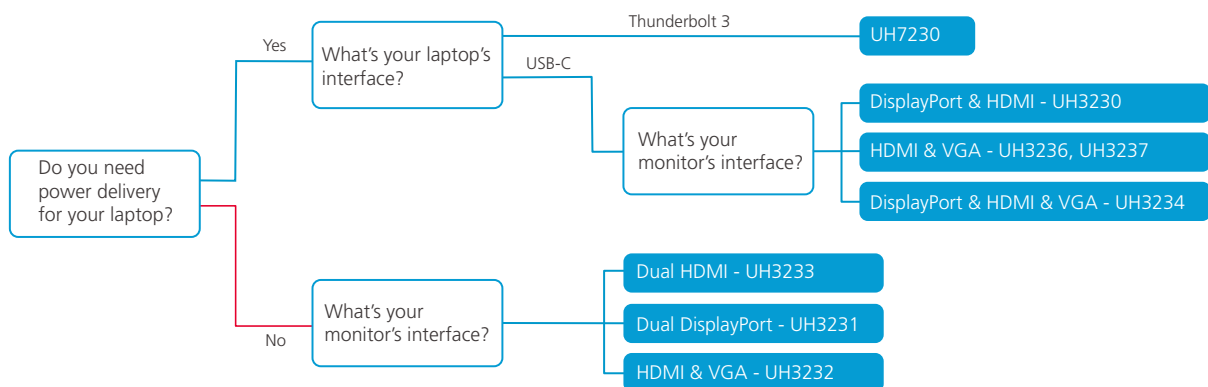

UH3236

USB-C Multiport Mini Dock with Power Pass-Through



OS Support
Win, Mac
USB 3.1
Gen 1
Power
Pass-Thru
PD 3.0



Features

- Connects up to 5 devices to a laptop through a single USB-C cable
- Supports 4K HDMI (3840 x 2160 @ 30Hz) resolutions or VGA (1920 x 1200 @ 60Hz) resolutions¹
- Supports USB Power Delivery 3.0 for laptop charging up to 60W via USB-C power adapter – power profiles include 5V, 9V, 12V, 15V, 20V²
- Gigabit Ethernet port
- Plug and Play – no drivers needed
- Works with all major operating systems: Windows®, OS X®, and Android®³

1. With 7th- Generation Intel® Core™ Processor (Kaby Lake) and above. For video output to work through a USB-C port, it must support DP Alt Mode.
2. The total charging time may vary depending on the spec of USB-C power adapter connected to the UH3236.
3. Support mirror mode only.

Specifications

Function	UH3236
Computer Connections	1
Cable Length	35 cm
Connectors	
Computer	1 x USB-C Male (Black)
Device	1 x USB 2.0 Type-A Female (Black) 1 x USB 3.1 Gen 1 Type-A Female (Blue)
Video Output	1 x HDMI Female (Black) 1 x VGA Female (Black)
LAN Ports	1 x Gigabit Ethernet Female (Black)
Power	1 x USB-C Female Support Power Delivery 3.0 for laptop charging up to 60W* *USB-C Power Adapter from laptop is needed for Power Delivery Pass-Through function.
Video Resolution	Single View: HDMI - 3840 x 2160 @ 30 or VGA - 1920 x 1200 @ 60
Power Consumption	DC5V: 12.5W
Environmental	
Operating Temperature	0–40°C
Storage Temperature	-20–60°C
Humidity	0–80% RH, Non-condensing
Physical Properties	
Housing	Plastic
Weight	0.08 kg (0.18 lb)
Dimensions (L x W x H)	14.00 x 5.50 x 1.60 cm (5.51 x 2.17 x 0.63 in.)
Carton Lot	20 pcs

UH3234

USB-C Multiport Dock with Power Pass-Through (13")



OS Support
Win, Mac

USB 3.1
Gen 1

DisplayPort

Dual View
1080P

Power
Pass-Thru

PD 2.0

10

Thunderbolt & USB



Features

- Connects up to 10 devices instantly through a USB-C cable
- Supports USB Power Delivery 2.0 (PD 2.0) for laptop charging up to 60W via USB-C power adapter - power profile include 5V, 9V, 12V, 20V.¹
- Supports 4K resolution on a single HDMI or DisplayPort display, and Dual 1080p² on a DisplayPort and an HDMI or VGA monitor
- 1 x USB 3.1 Gen 1 Type-A port supports Battery Charging V1.2 (BC 1.2) for Fast-Charging device
- Built-in memory card readers (SD/MMC/Micro SD)³
- Audio line-in and line-out
- Gigabit Ethernet
- Stylish and ultra slim design allows user to place the 13" laptop directly on the top of docking station and save more space on desk
- Enhanced EMI protection by increasing the cable braid density and adding conductive foam to avoid electromagnetic interference

1. With 7th- Generation Intel® Core™ Processor (Kaby Lake) and above. For video output to work through a USB-C port, it must support DP Alt Mode. For Dual-View to work, a computer's graphics card must support MST technology
2. Mac computers only support single-view output.
3. SD and Micro SD Card cannot be used at the same time; functionality accords to the order of insertion.

Specifications

Function	UH3234
Computer Connections	1
Connectors	
Computer	1 x USB-C Male
Device	1 x USB 3.1 Gen 1 Type-A Female with BC1.2* 2 x USB 3.1 Gen 1 Type-A Female*
Video Output	*The total output of 3 x USB 3.1 Gen 1 Type-A Female is 10W (5V/2A). 1 x DisplayPort Female 1 x HDMI Female 1 x VGA Female
LAN Ports	1 x Gigabit Ethernet Female
Audio	1 x 3.5mm Stereo 4-pole microphone and headphone jack
Power	1 x USB-C Female Power Delivery Pass-Through up to 60W* *Power Delivery Pass-Through requires original USB-C charger from laptop.
Performance	
Flash Memory	1 x SD/SDHC/SDXC card slot 1 x Micro SD/SDHC/SDXC (up to 128 GB) card slot
Video Resolution	Single View: DisplayPort - 3840 x 2160 @ 30 HDMI - 3840 x 2160 @ 30 VGA - 1920 x 1200 @ 60 Dual View: DisplayPort / HDMI - 1920 x 1080 @ 60 DisplayPort / VGA - 1920 x 1080 @ 60
Power Consumption	DC5V: 15W
Environmental	
Operating Temperature	0 – 40°C
Storage Temperature	-10 – 70°C
Humidity	10 – 90% relative humidity, non-condensing
Physical Properties	
Housing	Aluminum
Weight	0.32 kg (0.7 lb)
Dimensions (L x W x H)	28.00 x 7.50 x 1.45 cm (11.02 x 2.95 x 0.57 in.)
Carton Lot	10 pcs

UH3237

USB-C Multiport Dock with Power Pass-Through (15")



OS Support
Win, Mac

USB 3.1
Gen 1

Dual View
1080P

Power
Pass-Thru

PD 3.0

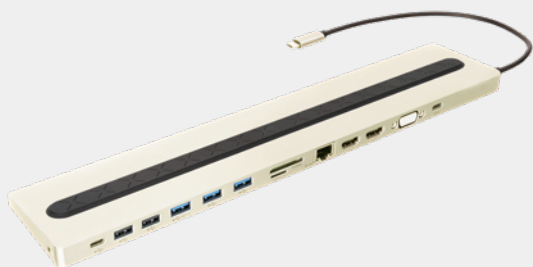

Features

- Expands up to 13 devices through a single USB-C Cable
 - Supports single display output up to 4K @ 30Hz (3840 x 2160 @ 30Hz)¹ or dual display output up to 1080P (1920 x 1080 @ 60Hz)²
 - Supports USB Power Delivery 3.0 (PD 3.0) for laptop charging up to 85W via USB-C power adapter - power profile include 5V, 9V, 12V, 15V, 20V³
 - Stylish and ultra slim design allows user to place the 15" laptop directly on the top of docking station and save more space on desk
 - Includes 1 m USB-C Cable for higher flexibility and convenience
1. With 7th- Generation Intel® Core™ Processor (Kaby Lake) and above. For video output to work through a USB-C port, it must support DP Alt Mode. For Dual-View to work, a computer's graphics card must support MST technology.
 2. Mac computers only support single-view output.
 3. The maximum charging performance may be insufficient based on the laptop power adapter spec.

Specifications

Function	UH3237
Computer Connections	1
Connectors	
Computer	30 cm USB 3.1 Gen 1 Type-C tethered cable
Device	2 x USB 2.0 Type-A Female* 3 x USB 3.1 Gen 1 Type-A Female (Blue)* 1 x USB 3.1 Gen 1 Type-C Female (Data Only)* *The total output of the above ports is 10W (5V/2A).
Video Output	2 x HDMI Female 1 x VGA Female
LAN Ports	1 x Gigabit Ethernet Female (Black)
Audio	1 x 3.5mm Stereo 4-pole microphone and headphone jack 1 x USB-C Female*
Power	*Support maximum 100W USB-C power adapter input. *An original USB-C power adapter from laptop is needed for Power Delivery Pass-Through function. *Does not support USB Type-A to USB Type-C power cord / adapter.
Performance	
Flash Memory	1 x SD Card Slot (SD/SDHC/SDXC) 1 x Micro SD Card Slot (Micro SD/SDHC/SDXC up to 128G)
Video Resolution	Single View: HDMI - 3840 x 2160 @ 30 or VGA - 1920 x 1080 @ 60 Dual View: 2 x HDMI - 1920 x 1080 @ 60
Power Consumption	DC5V: 15W
Environmental	
Operating Temperature	0–40°C
Storage Temperature	-20–60°C
Humidity	0–80% RH, Non-condensing
Physical Properties	
Housing	Top Cover – Aluminum Bottom Panel - Plastic
Weight	TBD
Dimensions (L x W x H)	TBD
Carton Lot	TBD

UH3230

USB-C Multiport Dock with Power Charging



Rear



Features

- Connect up to 8 devices to a laptop through a single USB-C cable
 - Supports HDMI 2.0 with 4K (UHD) resolutions¹
 - Supports DisplayPort 1.2 with 4K (UHD) resolutions¹
 - Analog audio line-in and line-out
 - Gigabit LAN port
 - Supports dual monitors in mirror and extended mode²
 - USB 3.1 Gen 1 front panel port supports Fast-Charging
 - Supports USB Power Delivery 2.0 for charging a laptop via USB-C port; supported power profiles include 20V/3A, 20V/1.8A, 12V/3A, and 5V/3A.
1. With 7th- Generation Intel® Core™ Processor (Kaby Lake) and above. For video output to work through a USB-C port, it must support DP Alt Mode.
 2. Mac computers only support single-view output.

10

Thunderbolt & USB

Specifications

Function	UH3230
Computer Connections	1
Connectors	
Device	1 x USB-C Female (Black, Data only) 3 x USB 3.1 Gen 1 Type-A Female (Blue)
Computer	1 x USB-C Female (Black)
Video Output	1 x DisplayPort Female (Black) 1 x HDMI Female (Black)
LAN Ports	1 x Gigabit Ethernet Female (Black)
Audio Inputs	1 x 3.5 mm Stereo audio Input (Black)
Audio Outputs	1 x 3.5 mm Stereo audio Output (Black)
Power Jack	1
LEDs	
Power	1 (White)
Video Resolution	<p>Single-View: DisplayPort- 3840 x 2160 @ 30* or HDMI - 4096 x 2160 @ 30</p> <p>Dual-View: DisplayPort 1 - 2048 x 1200 @ 60* or HDMI 2 - 1920 x 1200 @ 60</p> <p>*The UH3230 supports DP++ standard for using optional active / passive video adapter to convert DP signals to DVI/HDMI.</p>
Power	
Power Mode	Self-Powered
Consumption	DC20V: 90W
Environmental	
Operating Temperature	0 – 40°C
Storage Temperature	-20 – 60°C
Humidity	0 – 80% RH, Non-condensing
Physical Properties	
Housing	Metal
Weight	0.56 kg (1.24 lb)
Dimensions (L x W x H)	20.00 x 9.07 x 2.15 cm (7.87 x 3.57 x 0.85 in.)
Carton Lot	6 pcs
Included Accessories	1x AC Power Adapter with Cable; 1x 1m USB-C Cable

UH3231

USB-C Dual-DisplayPort Mini Dock



OS Support Win, Mac	USB 3.1 Gen 1	DisplayPort	Dual View 1080P
------------------------	------------------	-------------	--------------------

10

Thunderbolt & USB



Features

- Connects a USB-C computer to two DisplayPort monitors
- Supports 4K (UHD) resolutions via single display output¹
- Supports dual-display video output up to 1920 x 1080 simultaneously²
- USB 3.1 Gen 1 port with data transfer rates up to 5 Gbps
- Supports variety of video converters via Dual mode DisplayPort standard
- Plug and Play – no drivers or external power adapter needed

1. With 7th- Generation Intel® Core™ Processor (Kaby Lake) and above. For video output to work through a USB-C port, it must support DP Alt Mode. For Dual-View to work, a computer's graphics card must support MST technology.
2. Mac computers only support single-view output.

Specifications

Function	UH3231
Computer Connections	1
Connectors	
Computer	1 x USB-C Female (Black)
Device	1 x USB 3.1 Gen 1 Type-A Female (Blue)
Video Output	2 x DisplayPort Female (Black)
LEDs	
Power	1 (Blue / Orange)
Video Resolution	Single-View: DisplayPort - 3840 x 2160 @ 30* Dual-View: DisplayPort - 1920 x 1200 @ 60* *The UH3230 supports DP++ standard for using optional active / passive video adapter to convert DP signals to DVI / HDMI.
Power	
Power Mode	Bus-Powered
Consumption	DC5V: 0.81W
Environmental	
Operating Temperature	0 – 40°C
Storage Temperature	-20 – 60°C
Humidity	0 – 80% RH, Non-condensing
Physical Properties	
Housing	Plastic
Weight	0.10 kg (0.22 lb)
Dimensions (L x W x H)	9.37 x 9.30 x 2.68 cm (3.69 x 3.66 x 1.06 in.)
Carton Lot	20 pcs
Included Accessories	1x 1m USB-C Cable

UH3232

USB-C Multiport Mini Dock



Front



Features

- Connects a USB-C or Thunderbolt™ 3 computer to an HDMI/VGA, Ethernet and USB Type-A port via single cable
- USB 3.1 Gen 1 port with data transfer rates up to 5 Gbps
- Gigabit Ethernet LAN port
- Supports HDMI 1.4b with 4K (3840 x 2160 @ 30 Hz) resolutions; or VGA with 2K (2048 x 1152 @ 60 Hz) resolutions¹
- Supports Windows 10 (32-bit / 64-bit), Mac OSX Yosemite 10.10.5 and higher, OS X El Capitan 10.11 and higher
- Lightweight design – for easy transport

1. With 7th- Generation Intel® Core™ Processor (Kaby Lake) and above. For video output to work through a USB-C port, it must support DP Alt Mode.

Specifications

Function	UH3232
Computer Connections	1
Connectors	
Computer	1 x USB-C Male (Black)
Device	1 x USB 3.1 Gen 1 Type-A Female (Blue)
Video Output	1 x HDMI Female (Black) 1 x VGA Female (Black)
LAN Ports	1 x Gigabit Ethernet Female (Black)
Video Resolution	Single View: VGA - 2048 x 1152 @ 60 or HDMI - 3840 x 2160 @ 30
Power	
Power Mode	Bus-Powered
Consumption	DC5V: 7.865W
Environmental	
Operating Temperature	0 – 40°C
Storage Temperature	-20 – 60°C
Humidity	0 – 80% RH, Non-condensing
Physical Properties	
Housing	Plastic
Weight	0.07 kg (0.15 lb)
Dimensions (L x W x H)	15.88 x 10.80 x 1.52 cm (6.25 x 4.25 x 0.60 in.)
Carton Lot	20 pcs

UH3233

USB-C Dual-HDMI Mini Dock



OS Support Win, Mac	USB 3.1 Gen 1	Dual View 1080P
------------------------	------------------	--------------------

10

Thunderbolt & USB



Rear



Features

- USB 3.1 Gen 1 compliant
 - Connects a computer to two HDMI monitors with Dual-View output
 - Supports 4K (UHD) resolutions via single display output¹
 - Supports dual-display video output up to 1920 x 1080 simultaneously²
 - USB 3.1 Gen 1 port with data transfer rates up to 5 Gbps
 - Plug and Play – no drivers or external power adapter needed
1. With 7th- Generation Intel® Core™ Processor (Kaby Lake) and above. For video output to work through a USB-C port, it must support DP Alt Mode.
 2. For Dual-View to work, a computers graphics card must support MST technology. Mac computers only support single-view output.

Specifications

Function	UH3233
Computer Connections	1
Connectors	
Computer	1 x USB-C Female (Black)
Device	1 x USB 3.1 Gen 1 Type-A Female (Blue)
Video Output	2 x HDMI Female (Black)
LEDs	
Power	1 (Blue / Orange)
Video Resolution	Single View: HDMI - 3840 x 2160 @ 30 Dual View: HDMI - 1920 x 1200 @ 60
Power	
Power Mode	Bus-Powered
Consumption	DC5V: 2W
Environmental	
Operating Temperature	0–40°C
Storage Temperature	-20–60°C
Humidity	0–80% RH, Non-condensing
Physical Properties	
Housing	Plastic
Weight	0.10 kg (0.22 lb)
Dimensions (L x W x H)	9.37 x 9.30 x 2.68 cm (3.69 x 3.66 x 1.06 in.)
Carton Lot	20 pcs
Included Accessorie	1x 1m USB-C Cable

UH7230

Thunderbolt™ 3 Multiport Dock with Power Charging



OS Support
Win, Mac

USB 3.1
Gen 1

DisplayPort

Quick
Power
Charge

DP Dual
4K

PD 2.0



Rear



Features

- Supports both Thunderbolt 3 (40Gbps) and USB 3.1 Gen 2 (10Gbps) protocol through a single Thunderbolt 3 cable
- Connect up to 8 devices to a laptop via a single Thunderbolt 3 cable / can daisy-chain 5 additional Thunderbolt devices
- Supports 5K resolution on a single Thunderbolt 3 display or dual 4K resolution on one DisplayPort display and one USB-C / Thunderbolt 3 display
- 85W Universal Power Delivery for charging a Thunderbolt 3 laptop or MacBook pro ; supports 20V/4.25A, 15V/3A, 9V/3A and 5V/3A power specification for the output power
- Compatible with legacy Thunderbolt devices via adapter
- Gigabit Ethernet port
- Audio line-in and line-out
- OS Support: Windows 10 32/64 bit, and OS X Sierra 10.12 later

10

Thunderbolt & USB

Specifications

Function	UH7230
Computer Connections	1
Device Connections	
Direct	1
Maximum	5 Max. (via Thunderbolt Daisy-chaining)
Connectors	
Computer	1 x Thunderbolt 3 (USB-C) Female (Black)
Device	1 x Thunderbolt 3 (USB-C) Female (Black) 2 x USB 3.1 Gen 1 Type-A Female (Blue) 1 x USB 3.1 Gen 1 Type-C Female (Black)
LAN Ports	1 x Gigabit Ethernet Female (Black)
Audio Inputs	1 x 3.5 mm Stereo Input Female (Black)
Audio Outputs	1 x 3.5 mm Stereo Output Female (Black)
Power Jack	1
Video Output	1x DisplayPort Female; 1x Thunderbolt 3 (USB-C) Female
Video Resolution	<p>Single View: Thunderbolt 3 (USB-C) - 5K @ 60 USB-C - 4096 x 2160 @ 60 DisplayPort - 4096 x 2160 @ 60</p> <p>Dual View: Thunderbolt 3 (USB-C) or USB-C - 4096 x 2160 @ 60 DisplayPort - 4096 x 2160 @ 60</p>
Power	
Power Mode	Self-Powered
Consumption	DC20V: 170W
Environmental	
Operating Temperature	0 – 40°C
Storage Temperature	-20 – 60°C
Humidity	0 – 80% RH, Non-condensing
Physical Properties	
Housing	Aluminum
Weight	0.37 kg (0.83 lb)
Dimensions (L x W x H)	22.20 x 8.20 x 2.60 cm (8.74 x 3.23 x 1.02 in.)
Carton Lot	3 pcs
Included Accessorie	AC Power Adapter with Cable: 1x Thunderbolt 3 USB-C Cable

US3310

2-Port USB 3.1 Gen 1 Type-C Dock Switch with Power Pass-Through



OS Support
Win, Mac

Power Pass-Thru

USB 3.1 Gen 1

PD 2.0



Front



Rear



Features

- Allows USB-C laptop and Android Smartphone to share one HDMI monitor and all the connected peripherals
- Easily access and switch between two hosts with the press of a button
- Supports 4K resolution on a single display output¹
- Supports USB Power Delivery 2.0 for laptop charging up to 85W via USB-C power adapter

1. With 7th- Generation Intel® Core™ Processor (Kaby Lake) and above. For video output to work through a USB-C port, it must support DP Alt Mode.

Specifications

Function	US3310
Computer Connections	2
Connectors	
Computer	2 x USB 3.1 Gen 1 Type-C Female
Device	2 x USB 3.1 Gen 1 Type-A Female
Video Output	1 x HDMI Female 1 x USB Type-C Female*
Power	*Support USB PD 2.0 at 5V/9V/15V/20V up to 85W for laptop charging. *Provides 5V/2A for smartphone charging. *USB-C power adapter from laptop is needed for Power Delivery Pass-Through function.
Video Resolution	Laptop - 3840 x 2160 @ 30 Smartphone - 1920 x 1080 @ 60
Power Consumption	5V: 15W
Environmental	
Operating Temperature	0–40°C
Storage Temperature	-20–60°C
Humidity	0–80% RH, Non-condensing
Physical Properties	
Housing	Aluminum
Weight	TBD
Dimensions (L x W x H)	TBD
Carton Lot	TBD

US7220

2-Port Thunderbolt™ 2 KVM Docking Station



2-in-1 Docking Station / KVM Switch with Dual 4K Displays

OS Support Win, Mac	USB 3.1 Gen 1	HDMI Dual 4K
------------------------	------------------	-----------------

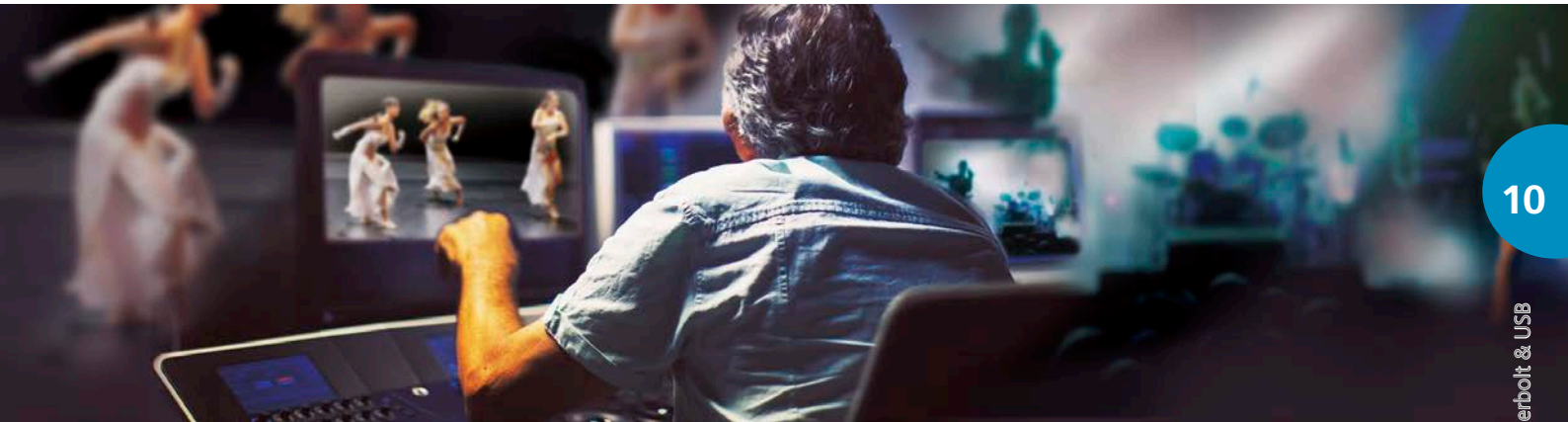

Features

- Thunderbolt 2.0 compliant with data transfer rates up to 20 Gbps
- Connect 11 devices to a laptop through a single Thunderbolt cable*
- Two Thunderbolt ports connect two Thunderbolt hosts
- One Thunderbolt port connects a Thunderbolt device and daisy-chains up to 5 additional devices
- Gigabit Ethernet port
- HDMI port supports an additional HDMI display
- Two USB 2.0 ports with data transfer rates up to 480 Mbps
- Supports three USB 3.1 Gen 1 ports with data transfer rates up to 5 Gbps
- Supports high-definition audio signals with Dolby and DTS pass-through via Mini TOSLINK; and 2.1 channel audio via 3.5 mm audio cable
- Analog/Digital audio line-in and line-out
- Supports HDMI 1.4b with 4K (UHD) resolution
- Supports DisplayPort 1.2 with 4K (UHD) resolution
- eSATA port for storage devices

Note: * Additional Thunderbolt cable sold separately.

• Ultra High Speed

Supports data throughput of up to 20 Gbps for next-gen versatility.

• Dual 4K Displays

Dual 4K output via Thunderbolt™ and HDMI ports for an unrestricted multimedia experience.

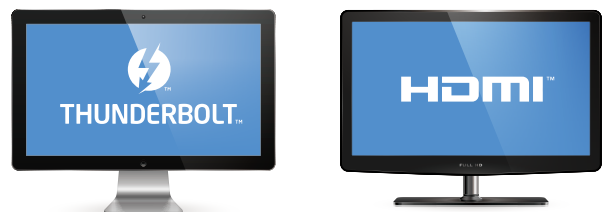
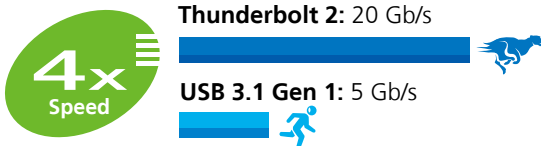

• Slick Operation

With the press of a button, two Thunderbolt™ computers can share 11 devices connected to the US7220. Additionally, up to 5 Thunderbolt™ devices can be daisy-chained from a single Thunderbolt™ connection, providing expandability and eliminating cable clutter.

Rear

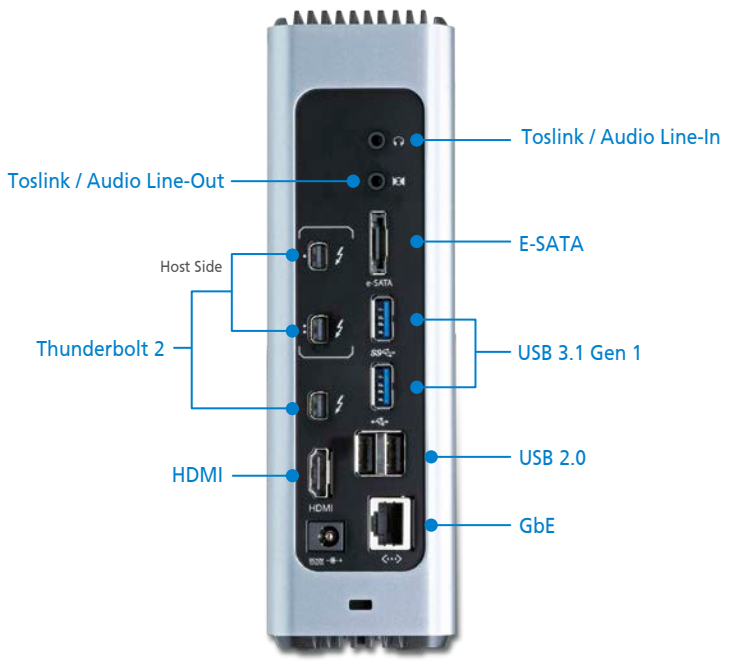

Setup > US7220

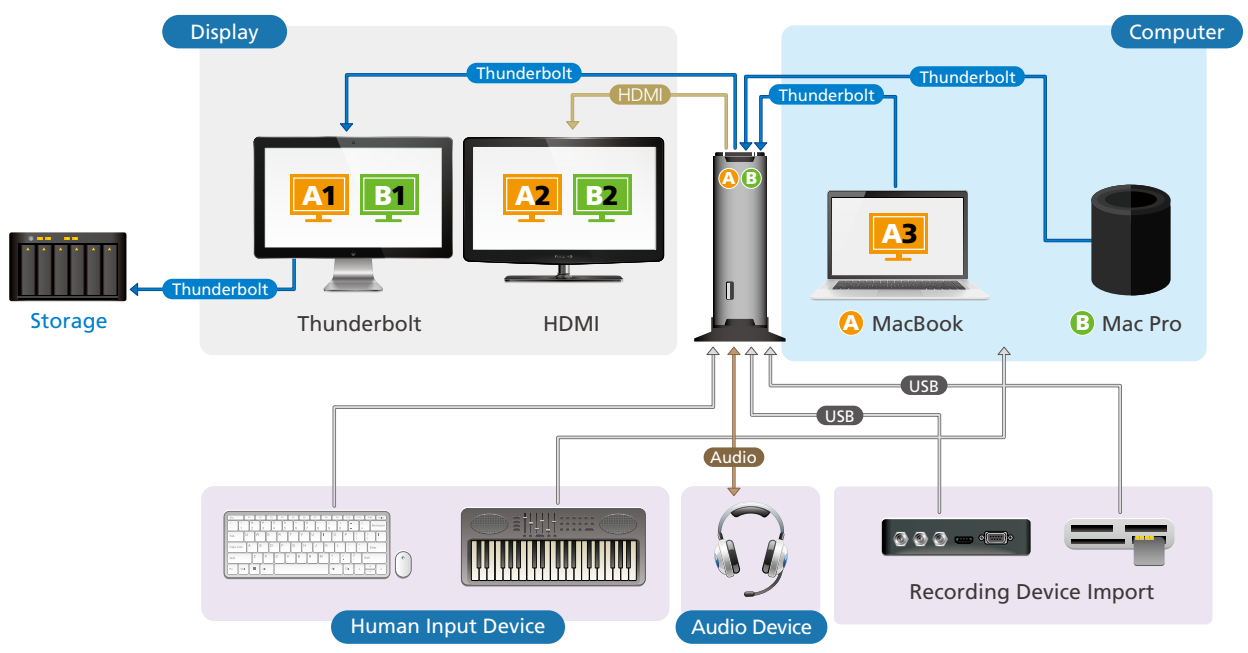

Specifications

Function	US7220
Computer Connections	2
Device Connections	5 Max. (via Daisy chain mode)
Connectors	
Computer	2 x Thunderbolt 2.0 Female (Black)
Device	1 x Thunderbolt 2.0 Female (Black) 3 x USB 3.1 Gen 1 Type-A Female (Blue) 2 x USB 2.0 Type-A Female (Black) 1 x E-SATA Female (Black)
Direct	1
Maximum	5 (via Daisy chain mode)
LAN Ports	1 x Gigabit Ethernet Female (Black)
Audio Inputs	1 x Stereo / Mini Toslink Jack Female (Black)
Audio Outputs	1 x Stereo / Mini Toslink Jack Female (Black)
Power Jack	1
Video Output	1 x HDMI Female (Black) 1 x Thunderbolt / Mini DisplayPort Female*
Port Selection	Port selection button x 2
LEDs	
Selected	2
Video Resolution	<p>Single View: Mini DisplayPort / Thunderbolt - 3840 x 2160 @ 60* HDMI - 3840 x 2160 @ 30</p> <p>Dual View: Thunderbolt - 3840 x 2160 @ 60 HDMI - 3840 x 2160 @ 30</p> <p>*The US7220 supports either HDMI or Mini DisplayPort, but not both.</p>
Power	
Power Mode	Self-Powered
Consumption	DC12V: 90W
Environmental	
Operating Temperature	0 – 40°C
Storage Temperature	-20 – 60°C
Humidity	0–80% RH, Non-condensing
Physical Properties	
Housing	Aluminum
Weight	0.78 kg (1.72 lb)
Dimensions (L x W x H)	5.70 x 9.75 x 19.19 cm (2.24 x 3.84 x 7.56 in.)
Carton Lot	3 pcs
Included Accessories	1x AC Power Adapter; 1x Thunderbolt Cable; 1x Vertical Stand;

UC3020

CAMLIVE™ HDMI to USB-C UVC Video Capture

OS Support

Win, Mac



1080P
Capture



Features

- Captures unencrypted HDMI video signal from camcorder or DSLR up to 1080P @ 60*
- Supports live video streaming, webcasting and video conferencing
- Compatible with popular streaming software, such as OBS, Xsplit, YouTube, Facebook and Twitch
- Plug and Play – supports UVC/UAC v1.1
- Compatible with USB 3.1 Gen 1 Type-C standard
- Works with all major operating systems: Windows® and OS X®

*CAMLIVE cannot display or capture HDCP protected content

Specifications

Function	UC3020
Connectors	
Video In	1 x HDMI Type A Female (Black)
USB Port	USB 3.1 Gen 1 Type-C Male (White) or USB 3.1 Gen 1 Type-A Male (via Dongle, Black)
Input	
Compliance	HDMI 1.4b, up to 1080p @ 60 (non-HDCP)
Input resolution	480P, 720P, 1080P
Audio	16-bit PCM audio, 32KHz, 44.1KHz and 48KHz
Output	
Video	Up to 1080P UVC video stream with UAC audio (Uncompressed video stream is only available on USB 3.1 connection)
Power Consumption	5V: 1.5W
Environmental	
Operating Temperature	0 - 40° C
Storage Temperature	-20 - 60° C
Humidity	0 - 80% RH, Non-Condensing
Minimum Hardware Requirements	CPU: Intel® i3 Dual Core 2.8Ghz or higher RAM: 4GB or more
OS Support	Windows 7 and above with UVC support Mac OS X 10.13 and above with UVC support
Physical Properties	
Housing	Aluminum
Weight	0.04 kg (0.09lb)
Dimensions (L x W x H)	7.30 x 4.20 x 1.40 cm (2.87 x 1.65 x 0.43 in.)
Carton Lot	10 pcs

UC3238

USB-C to 4K HDMI Cable (2.7 m)



OS Support

Win, Mac, Android



Features

- Connect a USB-C enabled laptop or smartphone which utilizes "DP Alt Mode" functionality to an HDMI compatible display using a single cable
- Supports resolution up to 4K @ 60Hz (3840 x 2160 @ 60Hz)
- Supports a long-distance connectivity of up to 2.7 meters
- No additional dongles and HDMI extension cables needed
- Plug and play – no drivers or external power adapter needed
- Works with all major operating systems: Windows®, OS X® and Android

UC3008

USB-C to 4K HDMI Adapter

OS Support

Win, Mac



Features

- Transfer high-quality video from a USB-C equipped laptop or tablet to a 4K HDMI display or projector
- Compatible with the latest USB-C equipped laptops and tablet computers, including Apple MacBook, Chromebook Pixel™, and Thunderbolt™ 3 computers
- USB billboard feature proactively notifies users of alternate USB-C modes supported by the source device
- Premium manufacturing and high quality design resists signal interference during video transmission
- Plug and Play - no software installation required

Specifications

Function	UC3238
Computer Connections	1
Connectors	
USB Port	1 x USB-C Male
Video Output	1 x HDMI Type-A Male
Video	
Max. Pixel Clock	594MHz
Max. Resolution	3840 x 2160 @ 60
Compliance	USB 3.1 Type-C with DP Alt Mode (Thunderbolt™ 3 Compatible), USB Billboard Device Class, HDCP 2.2, HDMI 2.0
Audio	
Output	1 x HDMI Type-A Male
Environmental	
Operating Temperature	0 – 40 °C
Storage Temperature	-20 – 60 °C
Humidity	0 - 80% RH, Non-Condensing
Physical Properties	
Housing	Plastic
Weight	0.16 kg (0.35 lb)
Dimensions (L x W x H)	6.40 x 2.10 x 1.10 cm (2.52 x 0.83 x 0.43 in.)
Carton Lot	20 pcs

Specifications

Function	UC3008
Video Input	
Interfaces	1 x USB-C Male (White)
Video Output	
Interfaces	1 x HDMI Type-A Female (Black)
Video	
Max. Pixel Clock	300 MHz
Max. Resolution	3840 x 2160 @ 30
Compliance	USB 3.1 Type-C with DP Alt Mode (Thunderbolt™ 3 Compatible), USB Billboard Device Class, HDCP 1.4, HDMI 1.4b
Audio	
Output	1 x HDMI Type-A Female (Black)
Power Mode	Bus-Powered
Environmental	
Operating Temperature	0 – 40°C
Storage Temperature	-20 – 60°C
Humidity	0 – 80% RH, Non-condensing
Physical Properties	
Housing	Plastic
Weight	0.03 kg (0.07 lb)
Dimensions (L x W x H)	7.00 x 2.70 x 1.50 cm (2.76 x 1.06 x 0.59 in.)
Carton Lot	20 pcs

UC3002

USB-C to VGA Adapter



10

Thunderbolt & USB

Features

- Transfer high-quality video from a USB-C equipped laptop or tablet to a VGA display or projector
- Compatible with the latest USB-C equipped laptops and tablets computers, including Apple MacBook, Chromebook Pixel™, and Thunderbolt™ 3 computers
- USB billboard feature proactively notifies users of alternate USB-C modes supported by the source device
- Premium manufacturing and high quality design resists signal interference during video transmission
- Plug and Play - no software installation required

Specifications

Function	UC3002
Video Input	
Interfaces	1 x USB-C Male (White)
Video Output	
Interfaces	1 x HDB-15 Female (Black)
Video Input	
Max. Pixel Clock	200 MHz
Max. Resolution	2048 x 1152 @ 60
Compliance	USB 3.1 Type-C with DP Alt Mode (Thunderbolt™ 3 Compatible), USB Billboard Device Class, HDCP 1.3
Power Mode	Bus-Powered
Environmental	
Operating Temperature	0 – 40°C
Storage Temperature	-20 – 60°C
Humidity	0 – 80% RH, Non-condensing
Physical Properties	
Housing	Plastic
Weight	0.03 kg (0.07 lb)
Dimensions (L x W x H)	7.00 x 2.70 x 1.50 cm (2.76 x 1.06 x 0.59 in.)
Carton Lot	20 pcs

UC485

USB to RS-422 / 485 Adapter



Features

- Converts a USB port to a Legacy RS-422 or RS-485 COM port
- Fast COM Port Transmission – up to 921.6 Kbps
- Package included DB-9 female to terminal block adapter for easy wiring
- Supports Terminal / ECHO mode by mode selector
- Supports Windows Vista / 7 and above, Mac and Linux
- Plug and Play – no power supply needed

Specifications

Function	UC485
Connectors	
USB Port	1 x USB Type-A Male (White)
Serial	1 x DB-9 Male (Silver)
Data Rate	Up to 921.6Kbps
Cable Length	1.2 m
LEDs	Power Status / RS-422 (Orange), RS-485 (Green)
Power Mode	Bus-Powered
USB Specification	USB Compliant
Environmental	
Operating Temperature	0 – 40°C
Storage Temperature	-20 – 60°C
Humidity	0 – 80% RH, Non-condensing
Physical Properties	
Housing	Plastic
Dimensions (L x W x H)	9.53 x 4.10 x 2.20 cm (3.75 x 1.61 x 0.87 in.)
Weight	0.09 kg (0.2 lb)
Carton Lot	40 pcs

UC232B

USB to RJ-45 (RS-232) Console Adapter



Features

- Converts a USB port to RJ-45 console port (RS-232) for fast COM port transmission
- Data transfer rate up to 921.6 Kbps data transfer rate
- Support straight RJ-45 cable, no need to use rolled RJ-45 cable for connecting networking router, modem or network switch for configuration
- COM retention saves the assigned port settings for the device
- OS Compatibility: Windows, Mac, Linux
- Plug and Play – small and lightweight make it a perfect travel companion

Specifications

Function	UC232B
Connectors	
USB Port	1 x USB Type-A Male (White)
Serial	1 x RJ-45 Male (Silver)
Data Rate	Up to 921.6 Kbps
Cable Length	1.2 m
LEDs	Power Status
Power Mode	Bus-Powered
USB Specification	USB Compliant
Environmental	
Operating Temperature	0 – 40°C
Storage Temperature	-20 – 60°C
Humidity	0 – 80% RH, Non-condensing
Physical Properties	
Housing	Plastic
Weight	0.06 kg (0.13 lb)
Dimensions (L x W x H)	2.56 x 5.84 x 2.23 cm (1.01 x 2.3 x 0.88 in.)
Carton Lot	20 pcs

UC232A / UC232A1

USB to RS-232 Adapter (35 cm) / USB to RS-232 Adapter (100 cm)



Features

- Support the RS-232 Serial interface
- Up to 921.6 Kbps data transfer rate
- Full compliance with the USB specification
- Multiplatform support – Windows, Linux and Mac
- Works with industrial automation systems, scientific instruments, point of sale systems, and other specialized industrial and consumer applications

Specifications

Function	UC232A	UC232A1
Connectors		
USB Port	1 x USB Type-A Male (White)	
Serial	1 x DB-9 Male (Silver)	
Data Rate	Up to 921.6 Kbps	
Cable Length	35 cm	1 m
LEDs	Power (Orange)	
Power Mode	Bus-Powered	
USB Specification	USB Compliant	
Environmental		
Operating Temperature	0 – 40°C	
Storage Temperature	-20 – 60°C	
Humidity	0 – 80% RH, Non-condensing	
Physical Properties		
Housing	Plastic	
Weight	0.06 kg (0.14 lb)	0.07 kg (0.16 lb)
Dimensions (L x W x H)	6.59 x 3.40 x 1.60 cm (2.59 x 1.34 x 0.63 in.)	
Carton Lot	40 pcs	

UC2322 / UC2324 / UC4852 / UC4854

2 / 4-Port USB to RS-232 / 485 / 422 Hub



Front

- UC2322 / UC4852



- UC2324 / UC4854



Rear

- UC2322 / UC4852

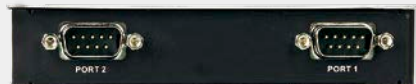

- UC2324 / UC4854



Features

- Easy way to add 2 / 4 serial ports
- Up to 115.2 Kbps data transfer rate for each serial port
- Supports RS-232 serial interface (UC2322 / UC2324)
- Supports RS-422 / RS-485 serial interface (UC4852 / UC4854)
- Dual data buffers for each upstream and downstream data transfer
- No IRQ, DMA, I/O address resources required
- Supports automatic handshake mode
- Supports both bus power and external power
- USB 2.0 compatible
- Supports hot-swapping and plug-and-play
- Built-in 16KV ESD protection
- Works with mobile phones, digital cameras, modems and ISDN terminal adapters
- OS support - Windows 2000 / 2003 / XP / NT

Specifications

Function	UC2322	UC2324	UC4852	UC4854
Device Connections	2	4	2	4
Connectors				
USB Port	1 x USB Type-B Female (White)			
Power	1 x DC Jack			
Serial	2 x DB-9 Male (Black)	4 x DB-9 Male (Black)	2 x DB-9 Male (Black)	4 x DB-9 Male (Black)
LEDs				
Ports	2 (Green)	4 (Green)	2 (Green)	4 (Green)
Power	1 (Orange)			
Data Rate	115.2 Kbps (max.)			
USB Specification	USB 2.0 Compatible			
Power Mode	Bus-Powered / Self-Powered by Optional Power Adapter			
Power Consumption	DC5V: 0.46W	DC5V: 0.4W	DC5V: 0.22W	DC5V: 0.50W
Environmental				
Operating Temperature	0 – 50°C			
Storage Temperature	-20 – 60°C			
Humidity	0 – 80% RH, Non-condensing			
Physical Properties				
Housing	Metal			
Weight	0.30 kg (0.66 lb)	0.32 kg (0.7 lb)	0.30 kg (0.66 lb)	0.32 kg (0.7 lb)
Dimensions (L x W x H)	12.50 x 8.00 x 2.50 cm (4.92 x 3.15 x 0.98 in.)			
Carton Lot	20 pcs			
Included Accessories	1x USB Cable; 1x Installation Disk			

UC1284B

USB to IEEE1284 Printer Adapter (1.8 m)



Features

- Converts the USB on PCs, laptop PCs and handheld computing devices into a parallel port for printer connection
- Fully bi-directional to ensure compatibility with today's latest printers
- 1 USB Type A connector for standard USB cable connection
- 1 C-36 parallel connector
- Bus-powered
- Max. throughput: 1.2 Mbits / Sec (ECP Mode)
- OS Support: Windows 2000 / Windows XP / Windows Vista and Windows 7

Specifications

Function	UC1284B
Connectors	
USB Port	1 x USB Type-A Male (White)
Printer	1 x C-36 Male
Data Rate	
	1.2 Mbits / Sec
Cable Length	
	1.8 m
LEDs	
	N/A
Power Mode	
	Bus-Powered
USB Specification	
	USB Compliant
Environmental	
Operating Temperature	0 – 40°C
Storage Temperature	-20 – 60°C
Humidity	0 – 80% RH, Non-condensing
Physical Properties	
Housing	Plastic
Dimensions (L x W x H)	0.11 kg (0.24 lb)
Weight	5.30 x 4.30 x 1.95 cm (2.09 x 1.69 x 0.77 in.)
Carton Lot	
	40 pcs

PHANTOM-S™

Gamepad to Keyboard Emulator for PS4 / Slim / Pro / PS3 / Xbox 360 / Xbox One / One S



www.aten.com/phantoms/

10

Thunderbolt & USB



Lethal Accuracy, Unbeatable Speed

Unparalleled precision for an outstanding FPS gaming experience.

The PHANTOM-S is ATEN's answer for gamers fed up with the drawback of laggy, imprecise controllers. Specially designed to assist the console gamer in FPS games, the PHANTOM-S™ gives you the freedom to abandon your conventional joystick to enjoy precision controls, enhanced accuracy, and continuous-fire with a keyboard and mouse on your favorite gaming console.

The PHANTOM-S™ employs ATEN's signal conversion technology for fully customizable mouse movements, enhanced continuous-fire with directed straight-line accuracy, sensitivity adjustments, macro settings, laptop operation, and regular updates that improve gameplay. Gameplay with the PHANTOM-S™ offers a satisfying PC-like experience of fast aiming and accurate shooting, even during burst firing.



Works with PS4 / Slim / Pro / PS3 / Xbox 360 / Xbox One / One S

- **Support for PS4™ Remote Play and Xbox Game Streaming**

The ATEN PHANTOM-S is fully compatible with both the PS4™ Remote Play application and Xbox game streaming, which allow you to control your game console from a computer. With the application installed on a PC, you can connect the PHANTOM-S™ and continue gaming with your KB/M while remotely connected to your game system.

- **Exclusive PLAY Mode for Laptops**

In addition to gameplay with a USB keyboard and mouse, the PHANTOM-S™ also supports laptop keyboards for direct PS3/4 and Xbox 360 / One gaming with unprecedented convenience and fluidity. You can connect the PHANTOM-S™ to a laptop and game console at the same time and switch keyboard use between the two. A laptop also allows you to configure settings using the PHANTOM-S™ software and quickly switch back to gameplay.

- **Download Pre-configured Setup Profiles for Specific Games**

Download pre-configured setup profiles for all of the hottest games. These profiles include keyboard mappings and dead-zones tailored to specific games and, what's more, you can even store and share your own profiles and download those shared by other members of the vibrant ATEN PHANTOM-S™ online community.

- **Supports Audio Pass-through for Xbox One / One S**

All audio features of your Xbox controller are supported by the PHANTOM-S™, meaning that you can plug your favorite compatible headset directly to your controller and hear the action just the way you like it, and easily adjust chat audio without taking your hands off your controls.

- **Unparalleled Precision and Tuning Capabilities**

Free software that allows you to easily set up your PHANTOM-S™ and configure KB/M mappings precisely to your own preferences – set up mouse sensitivity, geometries, mouse DPI, dead-zone, aim-down-sight (ADS) dead-zone, and macros so that a single key can carry out complex actions normally requiring up to 8 controller commands.

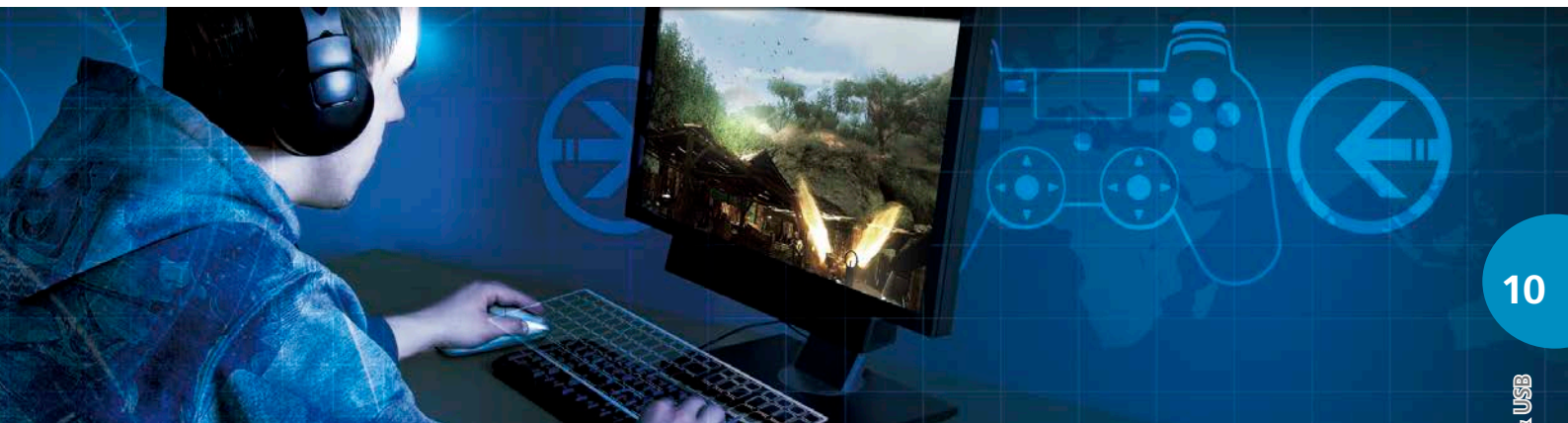

Setup > PHANTOM-S™

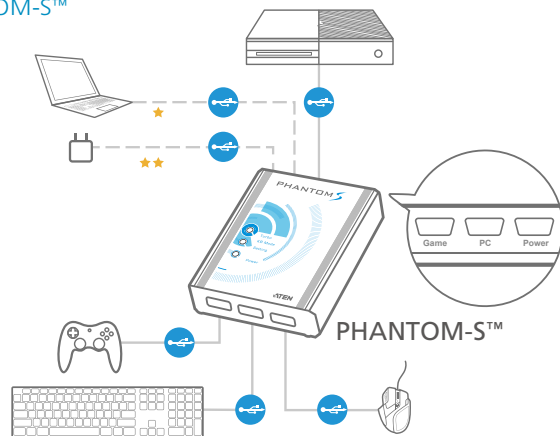

- ★ Connect to PC for software setting
- ★★ Connect additional power for some gaming keyboards with LED illumination or USB hub functions

Specifications

Function	UC3410
Switches	
Reset	1 x Semi-recessed Pushbottom
LEDs	
Turbo / *KB Mode	1 (Orange)
Setting	1 (Blue)
Power	1 (Blue)
Emulation	
Keyboard	USB, Emulation
Mouse	USB, Emulation
Gamepad	USB, Bypass
Power	
Power Mode	Bus-Powered
Consumption	DC5V: 0.72W
Environmental	
Operating Temperature	0 – 50°C
Storage Temperature	-20 – 60°C
Humidity	0 – 80% RH, Non-condensing
Connectors	
Front	3 x USB Type-A Female (White)
Rear	3 x Mini USB Type-A Female (Black) 1 x 3.5 mm Data Jack (Black, Reserved)
Physical Properties	
Housing	Metal
Weight	0.20 kg (0.44 lb)
Dimensions (L x W x H)	10.64 x 7.90 x 2.44 cm (4.19 x 3.11 x 0.96 in.)
Carton Lot	20 pcs

US3342

USB-C Sharing Switch with Power Pass-through

OS Support
Win, Mac

USB-C

Power
Pass-Thru

USB
USB 3.1
Gen 2

PD 3.0

Seamless
Sharing



Front



Rear



Features

- Enables 2 computers to share one set of USB keyboard or mouse, HDD storage, and peripheral devices via a pushbutton and software
- USB 3.1 Gen 2 compliant, supporting data transfer rates up to 10 Gbps
- Power Delivery Pass-through provides Quick Charge for a laptop
- Seamless Sharing – Enable file transfer function and mice control cross Windows or Mac platform
- Over-current protection
- Multiplatform support – Windows and Mac
- Bus-powered (supporting optional power adapter)
- Hot-pluggable

Specifications

Function	US3342
Computer Connections	2
Connectors	
Computer	2 x USB 3.1 Gen 2 Type-C Female (Black)
Device	3 x USB 3.1 Gen 2 Type-A Female (Blue) 1 x USB 3.1 Gen 2 Type-C Female (Black)
Power	1 x USB Type-C PD Female
Port Selection	
Input	Remote port selector / Software
Power Consumption	5V: 15W
LEDs	
Selected	2 (White)
Environmental	
Operating Temperature	0-40°C
Storage Temperature	-20-60°C
Humidity	0-80% RH, Non-condensing
Physical Properties	
Housing	Aluminum
Weight	TBD
Dimensions (L x W x H)	TBD
Carton Lot	TBD

US3344I

4x4 USB 3.1 Gen 1 Industrial Hub Switch

OS Support Win, Mac, Linux	USB 3.1 Gen 1	Terminal Block Data / DC Power
-------------------------------	------------------	-----------------------------------

Front



Rear



Features

- Enables four computers to share USB peripheral up to four devices
- Supports USB 3.1 Gen 1 specification, maximum data transfer rates up to 5Gbps
- Multiplatform support - Windows, Mac and Linux
- LED indicators display port focus
- Metal mechanical cassis with wall mountable designs
- Support aftermarket USB M2 screw locking cable
- Support port selection via remote controller or RS-422/RS-485 link through 5-pin terminal block
- Hot pluggable
- Support DC 9-24V power input by terminal block
- Support Battery Charging V1.2 and over current protection

Specifications

Function	US3344I
Computer Connections	4
Connectors	
Computer	4 x USB Type-B Female (Blue)
Device	4 x USB Type-A Female (Blue)
Serial	1 x 5-pin Terminal Plug (Green)
Power	1 x 2-pin 9-24V Terminal Plug (Green)
Power (Optional)	1 x 12V DC Jack Female (Black)
Port Selection	Remote port selector / Serial command
LEDs	
Selected	4 (Green)
Serial	RS-422 (Orange) RS-485 (Green)
Cable Length	
USB Cable	2x USB 3.1 Gen 1 Type-B to Type-A Cables 1.2 m 2x USB 3.1 Gen 1 Type-B to Type-A Cables 1.8 m
Remote Port Selector	1.8 m
Environmental	
Humidity	0-80% RH, Non-condensing
Operating Temperature	0-50°C
Storage Temperature	-20-60°C
Physical Properties	
Housing	Metal
Weight	1.04 kg
Dimensions (L x W x H)	20.00 x 8.00 x 2.50 cm
Carton Lot	5 pcs

US234 / US434 / US3324 / US3344

2x4 / 4x4 USB 3.1 Gen 1 Peripheral Sharing Switch



Front

- US234 / US434 / US3324 / US3344



Rear

- US234 / US3324



- US434 / US3344



Features

- Enables 2 (US234/US3324) / 4 (US434/US3344) computers to share 4 USB 3.1 Gen 1 devices
- Simple port selection via remote port selector for convenient switch placement
- USB 3.1 Gen 1 compliant, supporting data transfer rates of up to 5Gbps
- LEDs indicates which computer is active
- Over-current protection
- Micro USB power jack for additional power supply
- Bus-powered – no external power supply needed
- Plug and Play – no drivers or external power adapter needed
- Multiplatform support – Windows, Linux and Mac
- Additional USB 3.1 Gen 1 Type-B to Type-C cable included in the US3324 / US3344 package

Specifications

Function	US234	US434	US3324	US3344
Computer Connections	2	4	2	4
Port Selection	Remote port selector			
Connectors				
Computer	2 x USB Type-B Male (Black)	4 x USB Type-B Male (Black)	2 x USB Type-B Male (Black)	4 x USB Type-B Male (Black)
Device	4 x USB Type-A Female (Blue)			
Power (Optional)	1 x USB mini B Female (Black)			
Cable Length				
USB Cable	2 x USB 3.1 Gen 1 B to A Cable 1.2 m	2 x USB 3.1 Gen 1 B to A Cable 1.2 m / 2 x USB 3.1 Gen 1 B to A Cable 1.8 m	2 x USB 3.1 Gen 1 B to A Cable 1.2 m / 1 x USB 3.1 Gen 1 B to C Cable 1.8 m	2 x USB 3.1 Gen 1 B to A Cable 1.2 m / 2 x USB 3.1 Gen 1 B to A Cable 1.8 m / 2 x USB 3.1 Gen 1 B to C Cable 1.8 m
Remote Port Selector	1.8 m			
LEDs				
Selected	2 (White)	4 (White)	2 (White)	4 (White)
Environmental				
Operating Temperature	0 – 40°C			
Storage Temperature	-20 – 60°C			
Humidity	0–80% RH, Non-condensing			
Physical Properties				
Housing	Plastic			
Weight	0.12 kg (0.26 lb)	0.13 kg (0.29 lb)	0.45 kg (0.99 lb)	0.70 kg (1.55 lb)
Dimensions (L x W x H)	9.37 x 9.30 x 2.68 cm (3.69 x 3.66 x 1.06 in.)			
Carton Lot	10 pcs			

US224 / US424

2x4 / 4x4 Port USB 2.0 Peripheral Sharing Switch



Features

- Simple port selection via remote port selector for convenient switch placement
- Built-in USB ports – all-in-one design allows for a neat and tidy installation that reduces cable clutter
- Enables 2 / 4 computers to share 4 USB devices – a USB keyboard, mouse and up to 2 peripheral devices
- USB 2.0 compliant
- Multiplatform support – Windows, Linux, Mac and Sun
- LED indicators display port focus
- Overcurrent protection
- Bus-powered (supports optional USB power adapter)
- Hot pluggable

Specifications

Function	US224	US424
Computer Connections	2	4
Port Selection	Remote port selector	
Connectors		
Computer	2 x USB Type-A Male (Black)	4 x USB Type-A Male (Black)
Device	4 x USB Type-A Female (Black)	
Power (Optional)	1 x USB mini B Female (Black)	
Cable Length		
USB Cable	2 x 1.2 m	2 x 1.2 m / 2 x 1.8 m
Remote Port Selector	1.8 m	
LEDs		
Selected	2 (Green)	2 (Green / Orange)
Power Mode	Bus-Powered	
Environmental		
Operating Temperature	0 – 40°C	
Storage Temperature	-20 – 60°C	
Humidity	0 – 80% RH, Non-condensing	
Physical Properties		
Housing	Plastic	
Weight	0.14 kg (0.31 lb)	0.22 kg (0.48 lb)
Dimensions (L x W x H)	8.24 x 6.65 x 2.53 cm (3.24 x 2.62 x 1 in.)	
Carton Lot	20 pcs	

US221A / US421A

2 / 4-Port USB 2.0 Peripheral Sharing Switch



• US221A

• US421A



10

Thunderbolt & USB

Features

- Auto switch function – no need for print server
- Supports multifunction printers
- Enables 2 / 4 computers share a single USB peripheral device
- Simple port selection via pushbuttons, configuration utility, or auto switch function
- Supports transfer rates up to 480 Mbps
- Multiplatform support – Windows and Mac
- LED indicators display port focus
- Overcurrent protection
- Bus-powered
- Hot pluggable
- Buzzer indicates switching between computers

Specifications

Function	US221A	US421A
Console Connections	2	4
Port Selection	Pushbuttons, Software, Auto Switch	
Connectors		
Computer	2 x USB Type-B	4 x USB Type-B
Device	1 x USB Type-A	
LEDs		
Devices	1 (Orange)	
Selected	2 (Green)	4 (Green)
Switches	1 x Pushbutton	4 x Pushbutton
Power Mode	Bus-Powered	
Environmental		
Operating Temperature	0 – 40°C	
Storage Temperature	-20 – 60°C	
Humidity	0 – 80% RH, Non-condensing	
Physical Properties		
Housing	Plastic	
Weight	0.06 kg (0.13 lb)	0.10 kg (0.22 lb)
Dimensions (L x W x H)	7.18 x 6.58 x 2.44 cm (2.83 x 2.59 x 0.96 in.)	10.40 x 7.96 x 2.20 cm (4.09 x 3.13 x 0.87 in.)
Carton Lot	20 pcs	
Included Accessories	1x USB Type A to USB Type B Cable; 1x Installation disk	

UE3310 / UE3315

10 m / 15 m USB 3.1 Gen 1 Extender Cable



Features

- Daisy-chainable, maximum distance of up to 50 m
- USB 3.1 Gen 1 and 2.0 compatible
- Ultra slim design and unique locker head design
- Multiplatform support – Windows and Mac
- Additional power adapter included

Specifications

Function	UE3310	UE3315
Connectors		
USB Port	1 x USB 3.1 Gen 1 Type-A (Male)	
Downstream	1 x USB 3.1 Gen 1 Type-A (Female)	
USB Specification	USB 3.1 Gen 1 / 2.0 for High / Full speed	
Cable Length	10 m	15 m
Data Rate	Up to 5 Gbps	
Power		
Power Mode	Bus-Powered / Self-Powered	
Consumption	5V: 4.5W	
Environmental		
Operating Temperature	0 – 40°C	
Storage Temperature	-20 – 60°C	
Humidity	0 – 80% RH, Non-condensing	
Physical Properties		
Housing	Plastic	
Weight	0.76 kg (1.67 lb)	1.17 kg (2.58 lb)
Dimensions (L x W x H)	8.19 x 2.22 x 1.75 cm (3.22 x 0.87 x 0.69 in.)	
Carton Lot	5 pcs	
Included Accessories	1x AC Power Adapter; 1x USB Extension Cable	

UE350A

5 m USB 3.1 Gen 1 Extender Cable



Features

- Extends the distance of one USB device up to 5 m
- USB 3.1 Gen 1 and 2.0 compatible
- Supports USB super-speed (5 Gbps)
- Plug and play – no additional software installation required
- Multiplatform support – Windows and Mac
- Bus-Powered*

Note: * Some USB devices may require a separate power adapter

Specifications

Function	UE350A
Connectors	
USB Port	1 x USB Type-A Male
Downstream	1 x USB Type-A Female
USB Specification	USB 3.1 Gen 1 / 2.0 for High / Full speed
Cable Length	5 m
Data Rate	Up to 5 Gbps
Power Mode	Bus-Powered
Environmental	
Operating Temperature	0 – 40°C
Storage Temperature	-20 – 60°C
Humidity	0 – 80% RH, Non-condensing
Physical Properties	
Housing	Plastic
Weight	0.22 kg (0.48 lb)
Dimensions (L x W x H)	6.02 x 4.00 x 2.40 cm (2.45 x 1.57 x 0.94 in.)
Carton Lot	10 pcs

UE250

5 m USB 2.0 Extender Cable (Daisy-chaining up to 25 m)



10

Thunderbolt & USB

Features

- Extends one USB device up to 5 m
- USB 2.0 compliant
- USB IF approved
- Fully compliant with USB electrical and Timing Specs for USB Hubs
- Multiplatform support – Windows and Mac
- Bus-powered

Specifications

Function	UE250
Connectors	
Device	USB Type-A Male USB Type-A Female
LEDs	
Link	1 (Green)
Overcurrent	1 (Red)
USB Specification	USB 2.0 for High / Full speed
Driver Support	Native Driver Support
Power Mode	Bus-Powered
Data Rate	Up to 480 Mbps
Environmental	
Operating Temperature	0 – 40°C
Storage Temperature	-20 – 60°C
Humidity	0 – 80% RH, Non-condensing
Physical Properties	
Housing	Plastic
Weight	0.20 kg (0.44 lb)
Dimensions (L x W x H)	6.02 x 4.00 x 2.40 cm (2.45 x 1.57 x 0.94 in.)
Carton Lot	20 pcs

UE150

5 m USB Extender Cable (Daisy-chaining up to 25 m)



Features

- Extends one USB device up to 5 m
- USB 2.0 compliant
- USB IF approved
- Fully compliant with USB electrical and Timing Specs for USB Hubs
- Multiplatform support – Windows and Mac
- Bus-powered

Specifications

Function	UE150
Connectors	
Device	USB Type-A Female
Signal Range	Up to 5 m
USB Specification	USB 2.0 for High / Full speed
Driver Support	Native Driver Support
Power Mode	Bus-Powered
Data Rate	Up to 12 Mbps
Environmental	
Operating Temperature	0 – 40°C
Storage Temperature	-20 – 60°C
Humidity	0 – 80% RH, Non-condensing
Physical Properties	
Housing	Plastic
Weight	0.19 kg (0.42 lb)
Dimensions (L x W x H)	6.02 x 4.00 x 2.40 cm (2.45 x 1.57 x 0.94 in.)
Carton Lot	25 pcs

UE2120 / UE2120H

12 m USB 2.0 Extender Cable (Daisy-chaining up to 60 m)
12 m 4-Port USB 2.0 Extender Cable (Daisy-chaining up to 60 m)



Features

- Extends USB device up to 12 m
- USB specification version 2.0 compliant
- Up to 4 extender cables (UE2120) and 1 Extender Hub (UE2120H) can be chained for a distance of up to 60 meters
- 4 downstream USB 2.0 ports (UE2120H only)
- Lockable mechanical design for secure connection (UE2120 only)
- Bus powered – no power adapter required
- Multiplatform support – Windows and Mac
- Plug and play – no additional driver required

UCE260

USB 2.0 Cat 5 Extender (up to 60 m)



Features

- Extends signal transmission distance of a USB devices up to 60 m via a Cat 5 / 5e / 6 cable
- USB specification version 2.0 compliant
- Supports hot plug and no software driver required
- The most cost-effective USB extender solution
- Includes an AC adapter to stabilize power supply

Specifications

Function	UE2120	UE2120H
Connectors		
USB Port	1 x USB Type A Male	
Downstream	1 x USB Type-A Female	4 x USB Type-A Female
LEDs		
	1 (Green)	
USB Specification		
	USB 2.0 for High / Full Speed	
Cable Length		
	12 m	
Power Mode		
	Bus-Powered	
Environmental		
Operating Temperature	0 – 40°C	
Storage Temperature	-20 – 60°C	
Humidity	0 – 80% RH, Non-condensing	
Physical Properties		
Housing	Plastic	
Weight	0.56 kg (1.23 lb)	0.63 kg (1.39 lb)
Dimensions (L x W x H)	6.40 x 2.20 x 1.30 cm (2.52 x 0.87 x 0.51 in.)	8.20 x 4.10 x 1.70 cm (3.23 x 1.61 x 0.67 in.)
Carton Lot		
	20 pcs	

Specifications

Function	UCE260
Local Unit	
Upstream Port	USB Type-A Male
Downstream Port	RJ-45 Female
Power Mode	Bus-Powered
Remote Unit	
Upstream Port	USB Type-A Female
Downstream Port	RJ-45 Female
Power Mode	Self-Powered, 5V: 13W
USB Specification	
	USB 2.0 for High / Full Speed
Built-In Cable Length	
	30 cm
Interconnect Cable	
	Cat 5 / 5e / 6 Cable
Signal Range	
	60 m
Environmental	
Operating Temperature	0 – 40°C
Storage Temperature	-20 – 60°C
Humidity	0 – 80% RH, Non-condensing
Physical Properties	
Housing	Plastic
Weight	0.07 kg (0.15 lb)
Dimensions (L x W x H)	6.30 x 3.10 x 2.19 (2.48 x 1.22 x 0.86 in.)
Carton Lot	
	20 pcs
Included Accessories	
	1x USB 2.0 Type-A to Type-B Cable

UCE60

USB Cat 5 Extender (up to 60 m)



Features

- Extends one USB device up to 60 m via a Cat 5 / Cat 5e / 6 cable
- USB 2.0 full speed compliant
- Provides support for any full-speed (12 Mb/s) or low speed (1.5 Mb/s) USB devices
- LED indicates when additional external power supply needed
- Embedded USB transceivers prevent signal loss
- Lowest cost solution for extending USB signals
- No additional installation software required
- Multiplatform support – Windows and Mac

Specifications

Function	UCE60
Connectors	
Local Unit	1 x USB Type-A Male (White) 1 x RJ-45 Female
Remote Unit	1 x USB Type-A Female (White) 1 x RJ-45 Female
USB Specification	USB 2.0 for High / Full speed
Interconnect Cable	Cat 5 / 5e / 6 Cable
Signal Range	60 m
Current Consumption	20mA
Power Mode	Bus-Powered
Environmental	
Operating Temperature	0 – 40°C
Storage Temperature	-40 – 85°C
Humidity	0 – 80% RH, Non-condensing
Physical Properties	
Housing	Plastic
Weight	0.14 kg (0.30 lb)
Dimensions (L x W x H)	6.28 x 3.10 x 2.19 cm (2.48 x 1.22 x 0.86 in.)
Carton Lot	20 pcs

UCE3250

4-Port USB 2.0 Cat 5 Extender (up to 50 m)



Features

- Extension distance of up to 50 m over a Cat 5 / 5e / 6 cable
- USB specification version 2.0 compliant
- Receives up to 4 USB peripherals of all types – flash drives, keyboards, mice, webcams, scanners, printers and more
- USB Lossless-Higher compatibility of remote USB devices
- Metal mechanical with wall mount design supports industrial deployment
- Supports Windows®, OS X®, and Linux®
- Plug and play

Specifications

Function	UCE3250L	UCE3250R
Connectors		
USB Port	1 x USB Type-B Female	4 x USB Type-A Female
Link	1 x RJ-45 Female	1 x RJ-45 Female
Power	N/A	1 x DC Jack
USB Specification	USB 2.0 for High / Full speed	USB 2.0 for High / Full speed
USB Devices Supported	N/A	4 Devices
Power Consumption	Bus-Powered	Self-Powered, 5V: 13W
Environmental		
Operating Temperature	0–50°C	
Storage Temperature	-20–70°C	
Humidity	0–80% RH, Non-condensing	
Physical Properties		
Weight	0.09 kg (0.2 lb)	0.16 kg (0.35 lb)
Housing	Metal	
Dimensions (L x W x H)	6.70 x 6.02 x 2.37 cm (2.64 x 2.37 x 0.93 in.)	6.33 x 11.04 x 2.41 cm (2.49 x 4.35 x 0.95 in.)
Carton Lot	5 sets	
Included Accessories	1x USB Type-A Male to Type-B Male Cable; 1x Power Adapter	

UEH4102 / UEH4112

4-Port USB 2.0 Cat 5 Extender over LAN / 4-Port USB 2.0 Cat 5 Extender over LAN (Multi-Link Extension)



Features

- Up to 100 m between extender and switch and between switches over Cat 5e / 6 / 7 cables
- USB specification version 2.0 compliant
- Supports Switchable USB - enables the Local and Remote extender pairings to be switched and controlled by software (UEH4112)
- Supports Simultaneous Users Interaction - multiple users in multiple locations can collaboratively view and edit common files over a LAN in real time (UEH4112)
- Extends USB transmission over a Gigabit Ethernet Local Area Network (LAN)
- Operates with all USB peripherals - flash drives, keyboards, mice, webcams, interactive whiteboards, and more

Specifications

Function	UEH4102L/UEH4112L	UEH4102R/UEH4112R
Connectors		
USB Port	1 x USB Type-B Female	4 x USB Type-A Female
Link	1 x Gigabit Ethernet Female	1 x Gigabit Ethernet Female
Power	N/A	1 x DC Power Jack
USB Specification	USB 2.0 for High / Full speed	USB 2.0 for High / Full speed
USB Devices Supported	N/A	4 USB Devices
Power Consumption	Bus-Powered	Self-Powered DC5V: 15W
Network Protocol	10/100/1000BASE-T Ethernet (recommend 1000BASE-T Ethernet for best performance)	10/100/1000BASE-T Ethernet (recommend 1000BASE-T Ethernet for best performance)
Environmental		
Operating Temperature	0 - 50° C	
Storage Temperature	-20 - 70° C	
Humidity	0 - 80% RH, Non-condensing	
Physical Properties		
Housing	Metal	Metal
Weight	0.19 kg (0.42 lb) / TBD (UEH4112)	
Dimensions (L x W x H)	10.00 x 7.60 x 2.60 cm (3.94 x 2.99 x 1.02 in.)	
Carton Lot	5 sets (UEH4102) / TBD (UEH4112)	

UEH4002A

4-Port USB 2.0 Cat 5 Extender (Up to 100 m)



Features

- Extends USB transmission distance up to 100 m
- Operates with all USB peripherals – flash drives, keyboards, mice, webcams, interactive whiteboards, and more
- Supports transparent USB 2.0 signals and true plug and play - no software or drivers required
- Works with all major operating systems: Windows, OS X and Linux

Specifications

Function	UEH4002AL	UEH4002AR
Connectors		
USB Port	1 x USB Type-B Female	4 x USB Type-A Female
Link	1 x RJ-45 Female	1 x RJ-45 Female
Power	N/A	1 x DC Power Jack
USB Specification	USB 2.0 High / Full Speed	
USB Devices Supported	N/A	4 USB Devices
Power Mode	Bus-Powered	Self-Powered, DC 5V: 15W
Signal Range	100 m	
Environmental		
Operating Temperature	0 – 50° C	
Storage Temperature	-20 – 70° C	
Humidity	0 – 80% RH, Non-condensing	
Physical Properties		
Housing	Metal	
Weight	0.38 kg (0.84 lb)	
Dimensions (L x W x H)	10.00 x 7.60 x 2.60 cm (3.94 x 2.99 x 1.02 in.)	
Carton Lot	5 sets	
Included Accessories	1x USB 2.0 Type A to Type B Cable	

UH275 / UH284

4-Port USB 2.0 Hub

4-Port USB 2.0 Hub with Magnetic



• UH275



• UH284



Features

- Compact design, easy to store anywhere
- Built-in magnet pad for quick mount and easy movement (UH284)
- Available in silver, black and burgundy (UH284)
- Provides 4 additional USB 2.0 ports to existing USB Systems
- 4 independent, fully functional, 480 Mbps downstream ports
- USB specification version 2.0 compliant
- Supports transfer rates of 1.5 / 12 / 480 Mbps
- Over-current protection
- Plug and play

Specifications

Function	UH275	UH284
Connectors		
USB Port	1 x USB Type-A Male (White)	1 x USB Mini Type-B Female (Black)
Downstream	4 x USB Type-A Female (White)	
Power	1x DC Jack (Black), optional	
USB Specification	USB 2.0 for High / Full speed	
LEDs		
Power	1 (Green)	
Output Voltage (Per Port)	DC 5V	
Environmental		
Operating Temperature	0 – 40°C	
Storage Temperature	-20 – 60°C	
Humidity	0 – 80% RH, Non-condensing	
Physical Properties		
Housing	Plastic	
Weight	0.04 kg (0.09 lb)	
Dimensions (L x W x H)	9.00 x 3.85 x 1.20 cm (3.54 x 1.52 x 0.47 in.)	8.30 x 3.40 x 1.47 cm (3.27 x 1.34 x 0.58 in.)
Carton Lot	20 pcs	40 pcs
Included Accessories	1x Power Adapter*	1x USB Cable

Note: * Model with power adapter included only



Data Communication

Creating a connection between two interfaces is no longer a problem with the ATEN range of reliable, cost-efficient, bi-directional converters. These are extremely useful in situations in which the only port available uses an interface that is different from the device "to which you need to connect." In addition, there are some "uncommon" standards that a converter can easily access which might otherwise be impossible or too expensive to consider. ATEN's range of converters has been designed to provide simple solutions to the problems of data loss and conversion difficulties. We offer a wide range of auto switches and interface converters "that" include serial PCI cards and parallel line extenders. The Bitronics-capable models allow you to take advantage of enhanced parallel port features, such as bi-directional communication, higher data throughput, and printer control from the keyboard.



11

Data Communication

- **Printer Network**

Simultaneous printing capability.

- **RS-232 to RS-422 / RS-485 Bi-Directional Converter**

RS-232 to RS-422/RS-485 converters for data transmission.

- **Serial PCI Card**

RS-232 / RS-422 / RS-485 converters and extenders are heavily represented in many enterprise fields.

- Telecommunications industry
- Auto-teller machines
- Airport check-in and flight schedule display systems
- Automatic postal machines

Note:

The features highlighted above are not available in all products. Please refer to each product page for more details. Product information is subject to change without prior notice.



Feature Comparison

Model No.	IC164T	IC164R
Input	1 x DB-25	1 x RJ-11 (F, 6P4C)
Output	1 x RJ-11 (F, 6P4C)	1 Centronics C-36
Output Port Selection	N/A	N/A
Timeout Selection (Sec.)	N/A	N/A
Signal Range	400 m	400 m
First-Come-First-Served	N/A	N/A
Bus-Powered	•	•
Baud Rates	21 K	21 K

Model No.	IC485S	IC485SI	IC485SN	IC485AI
Input	1 x DB-25	1 x DB-25	1 x DB-25	1 x DB-25
Output	RS-485 / RS-422 Four Terminal Block			
RJ-11 Connector	•	N/A	•	N/A
Grounding Tab	N/A	•	N/A	•
DCE / DTE Selectable	•	•	•	•
Monitor Configuration	•	N/A	N/A	N/A
Signal / Power Isolation	N/A	•	N/A	N/A
2000V Surge Protection	N/A	N/A	N/A	•
Operation Mode	Point to Point, Multidrop, Simplex			
Bus-Powered	N/A	N/A	•	N/A
Signal Range	1200 m	1200 m	1200 m	1200 m
Baud Rates	115.2 K	115.2 K	115.2 K	115.2 K

IC164

Non-Powered / High Speed Parallel Data Extender

OS Support
Win

Bus-Powered

• IC164T



• IC164R



Features

- Extends the distance between your parallel peripherals and the PC up to 400 m.
- Uses RJ-11 cable to connect the transmitter and receiver units.
- Easy to install and operate
- Non-powered
- Compact size

11

Data Communication

Specifications

Function	IC164R (Receiver)	IC164T (Transmitter)
Connectors	1 x C-36 Male 1 x RJ-11 Jack Female	1 DB x 25 Male 1 x RJ-11 Jack Female
Power (Optional)	DC9V: 0.4W (Min.)	
Data Rate	21 Kbytes / Sec.	
Cable Type	4 Wire Telephone Line	
Cable Length	400 m [1300'] (Max.)	
Environmental		
Operating Temperature	0 – 50°C	
Storage Temperature	-20 – 60°C	
Humidity	0 – 80% RH, Non-condensing	
Physical Properties		
Housing	Plastic	
Weight	0.05 kg (0.11 lb)	
Dimensions (L x W x H)	7.60 x 6.20 x 2.68 cm (2.99 x 2.44 x 1.06 in.)	
Carton Lot	20 sets	
Included Accessories	1x RJ-11 Cable	

IC485S / IC485SI / IC485SN

RS-232 / RS-485 Interface Converter



Features

- Monitor configuration support (IC485S)
- Signal and power isolation support (IC485SI)
- Non-powered operation (IC485SN)
- Data transmission controlled by the RTS signal
- DCE / DTE selectable
- Point-to-Point, multidrop and simplex / duplex link selection
- Compact size
- Cable distance up to 1200 m
- Supports baud rates up to 115.2 kbps

Specifications

Function	IC485S	IC485SI	IC485SN
Connectors	1 DB-25 Female (RS-232) RS-485 / RS-422 Four Terminal Block 1x RJ-11 Female	1 DB-25 Female (RS-232) RS-485 / RS-422 Four Terminal Block Grounding Tab	1 DB-25 Female (RS-232) RS-485 / RS-422 Four Terminal Block 1x RJ-11 Female
Power Consumption	DC9V: 0.82W (Max)	DC9V: 0.81W (Max)	DC9V: 0.03W
Data Rate	Up to 100 Kbps under 1200 m [4000']		
Signal Range	1200 m [4000'] (Max)		
Environmental			
Operating Temperature	0 – 50°C		
Storage Temperature	-20 – 60°C		
Humidity	0 – 80% RH, Non-condensing		
Physical Properties			
Housing	Plastic		
Weight	0.05 kg (0.11 lb)	0.06 kg (0.13 lb)	
Dimensions (L x W x H)	7.90 x 5.45 x 2.10 cm (3.11 x 2.15 x 0.83 in.)		
Carton Lot	20 pcs		
Included Accessories	1x Power Adapter		N/A

IC485AI

RS-232 to RS-422 / RS-485 Isolated Converter



11

Data Communication

Features

- Point-to-Point, multidrop and simplex operating modes
- Four wire full duplex; two wire half duplex
- Minimum 2000V isolation protection
- Automatic internal RS-485 bus supervision
- No external flow control signals for RS-485 required
- Transient suppression on RS-485 data lines

Specifications

Function	IC485AI
Connectors	1 DB-25 Female (RS-232) RS-485 / RS-422 Four Terminal Block Grounding Tab
Power Consumption	DC9V: 0.9W (Max)
Data Rate	Up to 100 Kbps Under 1200 m [4000']
Signal Range	1200 m [4000'] (Max)
Environmental	
Operating Temperature	0 – 50°C
Storage Temperature	-20 – 60°C
Humidity	0 – 80% RH, Non-condensing
Physical Properties	
Housing	Plastic
Dimensions (L x W x H)	0.06 kg (0.13 lb)
Weight	7.90 x 5.45 x 2.10 cm (3.11 x 2.15 x 0.83 in.)
Carton Lot	20 pcs
Included Accessories	1x Power Adapter

IC-108S

RS-232 8-Port PCI Card







































Features

- High-speed serial port supports baud rates up to 921.6 Kbps
- High-tech 128K FIFO can reduce CPU loading, interrupting, and improving system performance dramatically
- Plug and play, I/O address and IRQ assigned by BIOS
- Works with various types of DB9M / DB25M serial devices
- Fully compliant with PCI Spec. Ver2.2 standard
- Supports both 64-bit & 32-bit PCI Bus and 3.3V & 5V connector keys
- Ready for the Intel® Itanium® and AMD® Athlon® 64R 64-bit CPU on the Microsoft Windows® XP 64-bit Edition Version 2003 and Windows® Sever 2003 for 64-bit Itanium based or Extended Systems
- Ideal for 56K V.90 external modems, ISDN terminal adapters, PDA, UPS, barcode scanners and other high speed serial port devices
- Supports Microsoft Windows NT, 2000, XP, Vista, 2003, DOS and Linux

Specifications

Function	IC-108S
Mode of Operation	Hand-shaking Mode
Bus Transceivers	RS-232 Full-duplex
Drivers per Line	RS-232 1 Driver
Receivers per Line	RS-232 1 Receiver
Hardware	
Controller	UART (16C650 compatible)
Bus Interface	64-bit & 32-bit PCI Bus - 3.3V & 5V Connector Keys
Connector	1 DB37 Female port and 1 pin header to 8 port DB9 Male or DB25 Male
Communication	
IRQ & I/O Address	Assigned by BIOS
FIFO	32 bytes hardware FIFO, 128 Kbytes software FIFO
Baud Rate	75bps ~ 921.6Kbps
Data Bit	4, 5, 6, 7, 8
Stop Bit	1, 1.5, 2
Parity	even, odd, none, mark, space
Flow Control	None, Xon / Xoff, Hardware
Signals	DCD, RxD, TxD, DTR, GND, DSR, RTS, CTS, RI
Driver Supported	
64-bit System	Intel Itanium and AMD Athlon64 CPU
Microsoft	DOS, Windows 3.x / 9x / ME / NT / 2000 / XP / 2003
Linux	2.0.x / 2.2.x / 2.4.18 / 2.4.20
DOS	DOS
Environmental	
Operating Temperature	0 – 57°C
Storage Temperature	-20 – 85°C
Humidity	5 – 95% RH, Non-condensing
Carton Lot	20 pcs
Included Accessories	2x DB 37 pin to 4 port DB 9 cable; 1x Accessory cable; 1x Software CD



Cables

Images	Part No.	Interface	To PC / Source Interface	To Switch Interface	Compatible Products
	2L-1001P/C (1.8 m) 2L-1003P/C (3 m) 2L-1005P/C (5 m) 2L-1006P/C (6 m) 2L-1010P/C (10 m) 2L-1020P/C (20 m)	PS/2 Standard VGA	 		CS82A, CS84A, CS9134, CS9138
	2L-5001P/C (1.2 m) 2L-5002P/C (1.8 m) 2L-5003P/C (3 m) 2L-5005P/C (5 m)	PS/2 Slim VGA		 	
	2L-1001P (1.8 m) 2L-1003P (3 m) 2L-1005P (5 m) 2L-1010P (10 m) 2L-1020P (20 m) 2L-1030P (30 m) 2L-1040P (40 m)	PS/2 VGA	  	  	
Console					
	2L-5502UP (1.8 m) 2L-5503UP (3 m) 2L-5506UP (6 m)	USB VGA	 	  	CS82A, CS84A, CS9134, CS9138
	2L-5201P (1.2 m) 2L-5202P (1.8 m) 2L-5203P (3 m) 2L-5206P (6 m)	PS/2 VGA	  		ACS1216A, CE250A, CL1000, CL1008, CL1016, CL1308, CL1316, CL3000, CL5708, CL5716, CL5800, CL5808, CL5816, CL5708I, CL5716I, CN8000A, CS74E, CS231, CS1308, CS1316, CS1708A, CS1716A, CS1708I, CS1716I
	2L-5702P (1.8 m)	PS/2 VGA	  		ACS1216A, CE250A, CL1000, CL1008, CL1016, CL1308, CL1316, CL3000, CL5708, CL5716, CL5800, CL5808, CL5816, CL5708I, CL5716I, CN8000A, CS74E, CS231, CS1308, CS1316, CS1708A, CS1716A, CS1708I, CS1716I
	2L-5202UP (1.8 m) 2L-5203UP (3 m) 2L-5205UP (5 m) 2L-5206UP (6 m)	USB VGA	 		ACS1216A, CE250A, CE350, CE370, CL1000, CL1008, CL1016, CS74E, CS231
	2L-5202A (1.8 m) 2L-5203A (3 m) 2L-5205A (5 m)	VGA Audio	 		CS1742, CS1744



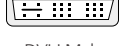

 About SPHD Connectors:
 Many of our KVM switches use SPHD connectors for their KVM and/or console ports. We have specifically modified the shape of these connectors so that only KVM cables that we have designed to work with the KVM switch can be connected.

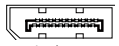
Images	Part No.	Interface	To PC / Source Interface	To Switch Interface	Compatible Products
G 	2L-5301UP (1.2 m) 2L-5302UP (1.8 m) 2L-5303UP (3 m)	USB PS/2 VGA	 USB Type A Male  HDB-15 Male  6 pin mini-DIN Male  6 pin mini-DIN Male	 SPHD Male	CN8000A, CS82U, CS84U, CL5808, CL5816, CS1308, CS1316,
H 	2L-5302UU (1.8 m) 2L-5303UU (3 m) 2L-5305UU (5 m)	USB VGA Audio	 USB Type A Male  USB Type A Male  2 Audio Plugs  HDB-15 Male	 SPHD Male  2 Audio Plugs	CS1774
I 	2L-1701P (1.8 m) 2L-1703P (3 m) 2L-1705P (5 m) 2L-1710P (10 m)	PS/2 VGA Audio	 6 pin mini-DIN Male  6 pin mini-DIN Male  2 Audio Plugs  HDB-15 Male	 Port DB-25 Male	CS228, CS428
J 	2L-1701S (1.1 m)	PS/2 VGA Audio	 6 pin mini-DIN Female  6 pin mini-DIN Female  2 Audio Plugs (Female)  HDB-15 Female	 Port DB-25 Male	CS228, CS428
K 	2L-5001U (1.2 m)	USB VGA	 USB Type A Male  HDB-15 Male	 USB Type B Male  HDB-15 Female	CE100
L 	2L-5301U (1.2 m) 2L-5302U (1.8 m) 2L-5303U (3 m) 2L-5305U (5 m)	USB VGA Audio	 USB Type A Male  HDB-15 Male  2 Audio Plugs	 SPHD Male  2 Audio Plugs	CE750A, CE770, CE774, CE775, CE800B, CL3100, CS1732B, CS1734B, CS1732A, CS1734A, CS1754, CS1758
M 	2L-5302P (1.8 m) 2L-5303P (3 m) 2L-5305P (5 m)	PS/2 VGA Audio	 6 pin mini-DIN Male  6 pin mini-DIN Male  2 Audio Plugs  HDB-15 Male	 SPHD Male  2 Audio Plugs	CE350, CE370, CS1732A, CS1734A, CS1732B, CS1734B, CS1754, CS1758
N 	2L-5201U (1.2 m) 2L-5202U (1.8 m) 2L-5203U (3 m) 2L-5205U (5 m)	USB VGA	 USB Type A Male  HDB-15 Male	 SPHD Male	CE700A, CL1308, CL1316, CL3000, CL3100, CL5708, CL5716, CL5800, CL5808, CL5816, CL5708I, CL5716I, CN8000A, CS72U, CS74U, CS82U, CS84U, CS231, CS1308, CS1316, CS1708A, CS1716A, CS1708I, CS1716I, CS1742, CS1744

Cables

Images	Part No.	Interface	To PC / Source Interface	To Switch Interface	Compatible Products
	2L-7D02U (1.8 m) 2L-7D03U (3 m) 2L-7D05U (5 m)	USB DVI-D Audio	  	  	CE600, CE604, CE610A, CE620, CE624, CE611, CE680, CE690, CL3800, CL6700MW, CL6708MW, CM1164A, CN8600 CS1182, CS1184, CS1642A, CS1644A, CS1762A, CS1764A CS1768, CS1782A, CS1784A, CS1788, CS261
	2L-7D02UI (1.8 m) 2L-7D03UI (3 m)	USB DVI-I Audio	  	  	CL6708MW, CN8600, CS1642A, CS1644A CS1768, CS1782A, CS1784A CS1788
	2L-7D02UD (1.8 m) 2L-7D03UD (3 m) 2L-7D05UD (5 m)	USB DVI-D Dual Link Audio	  	  	CE602, CS1182, CS1184, CS1642A, CS1644A, CS1782A, CS1784A, CS1788
	2L-7D02DD (1.8 m) 2L-7D03DD (3 m) 2L-7D05DD (5 m)	DVI-D Dual Link	 	 	CS1642A, CS1644A
	2L-7DX2U (1.8 m) 2L-7DX3U (3 m)	USB VGA Audio	  	  	CS1644A, CS1642A, CS1788, CS1768, CS1784A, CS1782A, CS1762A
	2L-7D02DH (1.8 m)	USB HDMI Audio	  	  	CE600, CE602, CE604 CE610A, CE620, CE624, CE680, CE690, CL3800, CL6700MW, CL6708MW, CM1164A, CN8600, CS1182, CS1184, CS1642A, CS1644A, CS1762A, CS1764A CS1768, CS1782A, CS1784A, CS1788, CS261
	2L-7D02UH (1.8 m)	USB HDMI Audio	  	  	CE820, CL3700, CL3800, CL6700MW, CS1792, CS1794, CS1798, CS17916, CM1284
	2L-7D02DP (2 m) 2L-7D03DP (3 m) 2L-7D05DP (5 m)	DisplayPort	 	 	CE920
	2L-1700 (0.6 m) 2L-1701 (1.8 m) 2L-1703 (3 m) 2L-1705 (5 m) 2L-1715 (15 m) Daisy Chain Cable	Daisy Chain Cable	 	 	ACS1216A, CS1708A, CS1716A, CS1708I, CS1716I, CL1008, CL1016, CL5708, CL5716, CL5808, CL5816, CL5708I, CL5716I
	2L-2801 Low Skew Cable	Cat 5	 	 	CE100, CE250A, CE350, CE370, CE600, CE602, CE604, CE610A, CE620, CE624, CE700A, CE750A, CE770, CE774, CE775, CE800B, CE820, CE920
	2L-2910 HDBaseT Cat 6 Cable	RJ-45	 	 	All ATEN HDBT products

Accessories

Image	Part No.	Product Name	Product Name
	2XRT-0003G	IR Extender Cable	CM1164A, CM1284
	2X-EA12	LockPro - HDMI Cable Lock	CL3700, CL3800, CS1798, CS17916
	2A-127G	DVI to HDMI Converter	Compatible with most models equipped with DVI interface
	2A-128G	HDMI to DVI Converter	Compatible with most models equipped with HDMI interface

Product Compatibility List

KVM	Expansion	
	Connection	Compatible KVMs
CL1308	Cascade	CS1308, CS1316, CS1732B
CL1316	Cascade	CS1308, CS1316, CS1732B
CL6708	Cascade	CS1768
CS1308	Cascade	CS1308, CS1316, CS1754, CS1758
CS1316	Cascade	CS1308, CS1316, CS1754, CS1758
CS1754	Cascade	CS1754, CS1758
CS1758	Cascade	CS1754, CS1758
CS1768	Cascade	CS1768
CS1788	Cascade	CS1788
CS1798	Cascade	CS1798
CS17916	Cascade	CS1798, CS17916
CS9134	Cascade	CS138A, CS9138, CS9134
CS9138	Cascade	CS138A, CS9138, CS9134
ACS1216A	Daisy-Chain	ACS1208A, ACS1216A, CS1708A*, CS1716A*
CL1008	Daisy-Chain	ACS1208A, ACS1216A
CL1016	Daisy-Chain	ACS1208A, ACS1216A
CL5708	Daisy-Chain	ACS1208A, ACS1216A, CS1708A, CS1716A
CL5716	Daisy-Chain	ACS1208A, ACS1216A, CS1708A, CS1716A
CL5808	Daisy-Chain	ACS1208A, ACS1216A, CS1708A, CS1716A
CL5816	Daisy-Chain	ACS1208A, ACS1216A, CS1708A, CS1716A
CL5708I	Daisy-Chain	ACS1208A, ACS1216A, CS1708A, CS1716A
CL5716I	Daisy-Chain	ACS1208A, ACS1216A, CS1708A, CS1716A
CS1708A	Daisy-Chain	ACS1208A, ACS1216A, CS1708A, CS1716A
CS1716A	Daisy-Chain	ACS1208A, ACS1216A, CS1708A, CS1716A
CM1164A	Cascade, Daisy-Chain	CM1164A, CM1284
CM1284	Cascade, Daisy-Chain	CM1164A, CM1284

Note: * Must be the primary device.

Hotkeys

Models	Hotkey Mode (Invoke Hotkeys)	Port Selection	Invoke OSD
CS1788, CS1768, CS1308, CS1316, CS1708A, CS1716A, CS1708I, CS1716I, CS1754, CS1758, CL3100, CL3700, CL3800, CL6708MW, CL5708, CL5716, CL5808, CL5816, CL5708I, CL5716I, CM1164A, CM1284, CS1798, CS17916	Default: Num Lock - or Alternate: Ctrl F12	Default: Num Lock - (n) Enter or Alternate: Ctrl F12 (n) Enter	Default: Scroll Lock Scroll Lock or Alternate: Ctrl Ctrl
CL1008, CL1016	Default: Num Lock -	Default: Num Lock - (n) Enter	Default: Scroll Lock Scroll Lock or Alternate: Ctrl Ctrl
ACS1216A	Default: Num Lock * or Alternate: Num Lock -	Default: Num Lock * (n) Enter or Alternate: Num Lock - (n) Enter	Default: Scroll Lock Scroll Lock or Alternate: Ctrl Ctrl
CS9134, CS9138	Ctrl Shift Alt	Ctrl Shift Alt (n) Enter	Default: Scroll Lock Scroll Lock or Alternate: Ctrl Ctrl
CS692, CS682, CS52A, CS52, CS782DP, CS72D	Default: Scroll Lock Scroll Lock or Alternate: Ctrl Ctrl	Default: Scroll Lock Scroll Lock Enter or Alternate: Ctrl Ctrl Enter	—
CS62S, CS62A	—	Scroll Lock Scroll Lock	—
CS64A	Num Lock -	Num Lock - (n)	—
CS62U, CS62US	Default: Num Lock - or Alternate: Ctrl F12	Scroll Lock Scroll Lock Alternate: Ctrl Ctrl	—
CS1642A, CS1644A, CS64U, CS64US, CS1942DP, CS1944DP, CS1792, CS1794, CS1782A, CS1784A, CS1762A, CS1764A, CS1742, CS1744, CS1732A, CS1734A, CS261, CS231, CS1922M, CS1924M, CS1922, CS1924, CS1912, CS1914, CS82U, CS84U, CS724KM	Default: Num Lock - or Alternate: Ctrl F12	Default: 1. Scroll Lock Scroll Lock Enter 2. Scroll Lock Scroll Lock (n) Enter or Alternate: 1. Ctrl Ctrl Enter 2. Ctrl Ctrl (n) Enter	—

Hotkeys

Models	Hotkey Mode (Invoke Hotkeys)	Port Selection	Invoke OSD
CS1732B, CS1734B	Default: Num Lock - or Alternate: Ctrl F12	Default: Num Lock - (n) Enter Num Lock - ← ; Num Lock - → Num Lock - ↑ ; Num Lock - ↓ or Alternate: Ctrl F12 (n) Enter Ctrl F12 ← ; Ctrl F12 → Ctrl F12 ↑ ; Ctrl F12 ↓	Default: Scroll Lock Scroll Lock or Alternate: Ctrl Ctrl
CS82A	—	Default: Scroll Lock Scroll Lock or Alternate: Ctrl Ctrl	—
CS84A	—	Ctrl Shift Alt (n) Enter	—
CS74E	—	Scroll Lock Scroll Lock ↓ ; Scroll Lock Scroll Lock ↑ ; Scroll Lock Scroll Lock fn	—
CS533	—	Alt Alt : Switch Port: Back	—

Legend:

- (n): The n stands for the computer's Port ID number (1, 2, 3, 4...).
- m**: Where Fn represents a function key (from [F1] to [F4]) that corresponds to the KVM port (1 to 4).
- ←** previous port;
- next port;
- ↑** last accessible port;
- ↓** first accessible port

Hotkeys

Our KVM switches provide an extensive, easy-to-use, hotkey function that makes it convenient to access, control, and configure your KVM installation from the keyboard. They offer the simplest way to access the connected computers.

Hotkey Mode

All hotkey operations begin with invoking Hotkey Mode. The invocation sequence depends on the product and the user's preference. In each case, there is a factory default sequence and an alternate sequence that the user can select instead. The Hotkey invocation sequence for each product is shown in the table. The default sequence is given first and appears in bold text.

Port Selection

Hotkey port switching simply involves pressing the appropriate hotkey sequence. In some cases, simply invoking Hotkey Mode cycles you through the available ports; in others, the sequence involves specifying the port ID that the computer you want to access is connected to; while in still other cases, it involves pressing one of the arrow keys.



Corporate Headquarters

ATEN International Co., Ltd.

3F, No.125, Sec. 2, Datung Rd., Sijhih District,
New Taipei City 221, Taiwan
Phone: +886-2-8692-6789 Fax: +886-2-8692-6767
<http://www.aten.com/global/en/>
E-mail: marketing@aten.com

America Region:

ATEN Technology Inc.

15365 Barranca Parkway, Irvine, CA 92618, U.S.A.
Phone: +1-949-428-1111 Fax: +1-949-428-1100
<http://www.aten.com/us/en/>
E-mail: sales@aten-usa.com

ATEN New Jersey Inc.

220 Davidson Avenue, Suite 404, Somerset,
NJ 08873, U.S.A.
Phone: +1-732-356-1703 Fax: +1-732-356-1639
<http://www.aten.com/us/en/>
E-mail: sales@aten-usa.com

Oceania Region:

ATEN ANZ Pty Ltd.

Suite 3. 19, 32 Delhi Road, North Ryde,
NSW 2113, Australia
Phone: +61-2-9114-9933 Fax: +61-2-8072-3723
<http://www.aten.com/au/en/> E-mail: sales@au.aten.com

Asia Pacific Region:

ATEN China Co., Ltd.

18/F, Tower A, Horizon International Tower, No.6,
Zhichun Road, Haidian District, Beijing, China 100088
Phone: +86-10-5225-0110 Fax: +86-10-8296-1318
<http://www.aten.com/cn/zh/> E-mail: sales@aten.com.cn

ATEN Japan Co., Ltd.

Tokyo Headquarters
ATEN Bldg. 8-4, Minami-senju 3-chome, Arakawa-ku,
Tokyo 116-0003, Japan
Phone: +81-3-5615-5810 Fax: +81-3-3891-3810
<http://www.aten.com/jp/ja/> E-mail: sales@atenjapan.jp

Osaka Branch

Awajimachi Dai-Building 3F
3-1-9, Awajimachi, Chuo-ku, Osaka-shi, 541-0047, Japan
Phone: +81-6-6229-5810 Fax: +81-6-6229-8810
<http://www.aten.com/jp/ja/> E-mail: sales@atenjapan.jp

ATEN Korea Co., Ltd.

B-303, 32, Digital-ro 9-gil,
Geumcheon-gu, Seoul 08512, Korea
Phone: +82-2-467-6789 Fax: +82-2-467-9876
<http://www.aten.com/kr/ko/> E-mail: sales@aten.co.kr

Atech Peripherals, Inc.

6F, No.133, Sec. 2, Datung Rd., Sijhih District,
New Taipei City 221, Taiwan
Phone: +886-2-8692-6969 Fax: +886-2-8692-6926
<http://www.aten.com/tw/zh/> E-mail: taiwan@aten.com

ATEN India Rep. Office

Unit 406, 4th Floor, Barton Center, M.G. Road,
Bangalore - 560001, India
Phone 1: +91-80-48517231 Phone 2: +91-9686151525
<http://www.aten.com> E-mail: South-Asia@aten.com

EMEA Region:

ATEN Infotech N.V.

Mijnwerkerslaan 34, 3550 Heusden-Zolder, Belgium
Phone: +32-11-531543 Fax: +32-11-531544
<http://www.aten.com/eu/en/> E-mail: sales@aten.be

ATEN U.K. Limited

466 Malton Avenue, Slough SL1 4QU, U.K.
Phone: +44-1753-539-121 Fax: +44-1753-215-253
<http://www.aten.com/gb/en/> E-mail: sales@aten.co.uk

ATEN Poland Sp. z o. o.

2 Gottlieb Daimler Street 02-460 Warsaw, Poland
Phone: +48-514-120-220
<http://www.aten.com/pl/pl/>
E-mail: poland@aten.com

ATEN Russia

Office 14212, No.14 Sereblyakova Proezd,
Moscow, Russia
Phone: +7-495-134-2808
<http://www.aten.com/ru/ru/> E-mail: russia@aten.com

ATEN Info İletisim Ltd.

Beştepe Mah. Yaşam Cad., Neorama Is Merkezi 13-A / 76
Yenimahalle Ankara, Turkey
Phone: +90-312-284-00-27 E-mail: turkey@aten.com

