

DIGITUS®



MAINCATALOG

2012-II



iPhone® BeamJack™ Site 14



Apple® Lade-Set Site 16



USB 3.0 zu HDMI Adapter Site 11

Content

Display and rack.....	4		
Multimedia		Cable	
Webcams	5	USB 2.0 Cables	125
USB Mikroskop, Webcams	7	USB 2.0 Cables & VGA Monitor Cables	127
DVB-T receiver, video grabber, soundadapter	8	VGA Monitor Cables	128
Graphic adapters	9	DVI Monitor Cables	129
Speaker sets.....	12	HDMI Monitor Cables.....	130
MP3 player accessories.....	13		
USB Chargers	15		
iPod®, iPhone®, iPad® Cables and adapters	16		
Gaming accessories.....	19		
Bluetooth products.....	20		
Keyboards	22		
Mice	23		
Mouse Pads.....	24		
Accessories			
Cleaning equipment.....	25		
USB 3.0 products	27		
USB Docking Stations.....	30		
HDD Enclosures	31		
USB Hubs & Card Reader	33		
USB card reader	36		
Notebook Power Supplies.....	37		
Notebook Power Supplies & Accessories	38		
USB Adapters	39		
USB Datalink Cables, Repeater.....	40		
USB Sharing Switches, USB Extender	41		
Front Panels, Mobile Racks.....	42		
Accessories.....	44		
Network			
Wireless LAN Products, 802.11n.....	66		
Wireless LAN Antennas.....	74		
Wireless LAN Accessories.....	76		
Powerline Products	77		
Gigabit Switches.....	79		
Fast Ethernet Switches.....	82		
Fast Ethernet Products	84		
Network USB Hubs.....	85		
Multifunction servers.....	86		
Print Servers.....	87		
NAS Servers.....	88		
Internet/Network Cameras.....	89		
Camera Mounting Accessories.....	93		
Power over Ethernet.....	94		
CAT 5e Patch Cables.....	95		
CAT 5e Flat Patch Cables.....	96		
CAT 6 Patch Cables	97		
Twisted Pair Raw Cable.....	98		
Network Infrastructure.....	99		
Data Cabinets.....	102		
Datacom			
Pocket and compact KVM switches.....	103		
Desktop KVM switches, Basic-Line.....	106		
Desktop KVM Switches, Combo-Line.....	108		
KVM Accessories.....	112		
KVM Cable Sets.....	114		
Video Solutions	116		

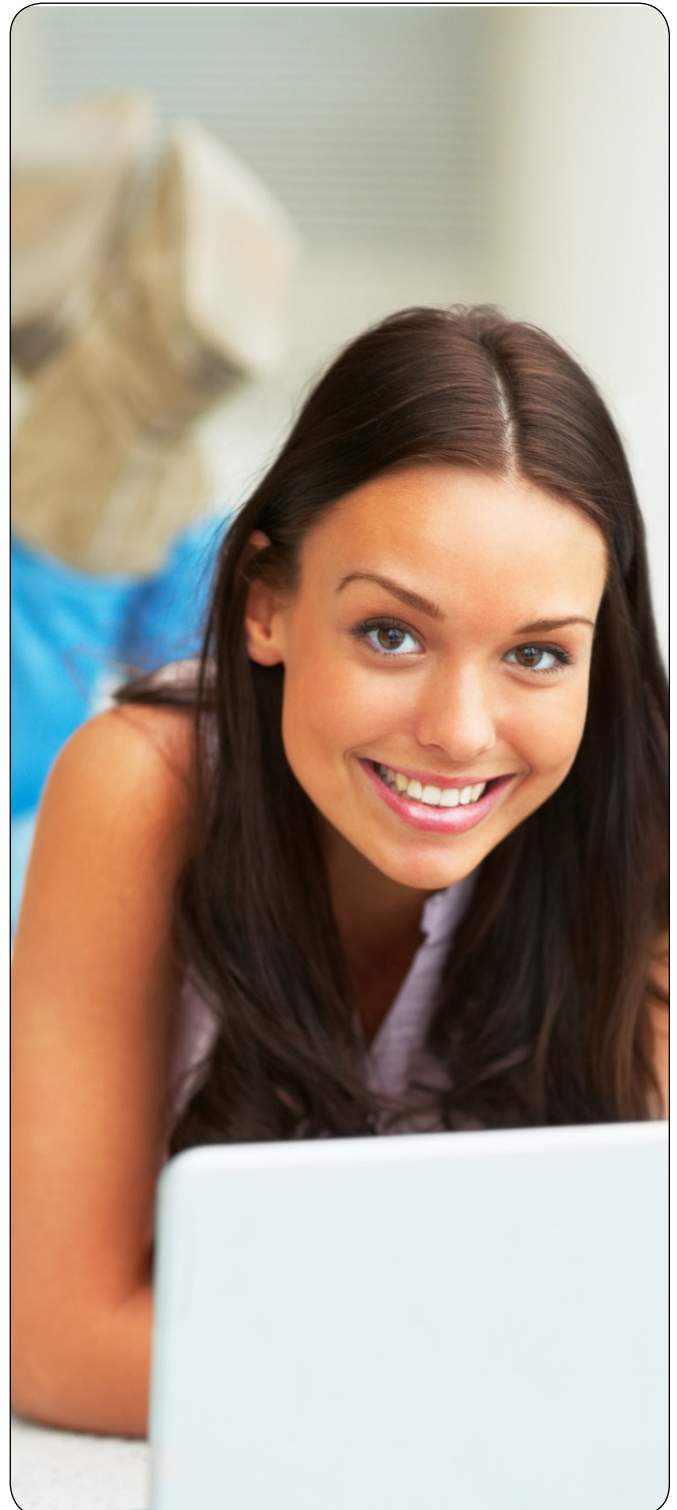

Apple® Counter Display (assembled)

Ready assembled out-of-the-box presenter

Apple® Counter Display purchased parts package

Package Content

- Apple® Counter Display (assembled)
- 1x Positioner - Apple® Counter Display with presentation stages DM-50004
- 1x Covering box with dividing wall for save transportation
- 4x iPod® USB Sync/charger cable DB-600100-003-S
- 4x iPod® USB Sync/charger cable DB-600100-005-W
- 4x iPod® USB Sync/charger cable DB-600100-010-W
- 2x iPod® Component with USB Audio/Video cable DB-600101-015-W
- 2x iPod® Adapter battery pack DB-600500-000-W
- 2x iPod® Car Charger Kit DB-600900-010-W
- 1x Apple® Accessories catalog, english DM-30028



306146 / DA-50005

Apple® Counter Display (assembled) - with german catalog

306153 / DA-50006

Apple® Counter Display (assembled) - with english catalog

DIGITUS® Warranty-Rack-Wobblers

The Wobblers are flexible displays, which are fixed on the rack to increase attention. They are equipped with a lenticular effect and convert from 5 to 15 Years Warranty, depending on the angle.



306375 / DM-50006

Warranty-Rack-Wobblers

DIGITUS® POS Rack System

The illuminated POS rack system especially developed for DIGITUS® blister packages and paper boxes to be stored on hooks and shelves.

- Rack color: black powder coating matte, shelf color: shiny grey powder coating
- The top-lightbox allows to show the whole range of cables and retail products
- Allows wall mount or stand-alone back-to-back placement (requires two racks)
- Mounting instruction and tool contained
- Made in Germany



Sample equipment.
Delivery excluding equipment.

302650 / DM-70109

POS Rack System

USB 2.0 HD Webcam

High-quality CMOS sensor with 2.0 Mega pixels

Present yourself in front of your family members and friends in high definition! This is now so easy as never before. Thanks to the high definition USB Webcam from Digitus. The USB 2.0 „plug and play“ HD Webcam has an integrated microphone, CMOS image sensor with 2.0 megapixels and a high definition resolution of 1280x720p. It is possible to reach a resolution of 16 megapixels via software interpolation and an expanded focus on a desired range by manual focus setting. The images will „smoothly“ transferred with a refresh rate of up to 30fps. The Included Magician software allows you to edit your images captured by special effects, image frames, etc. The flexible universal mounting guarantees a solid hold on LCD monitors and on laptops as well.

- High definition resolution 720p (1280x720p), via software interpolated up to 1080p
- Resolutions of up to 16 Mega pixels possible via software interpolation
- Built-in microphone
- Framerate up to 30fps
- USB 2.0 interface
- incl. IM Magician software for special effects, photo frames etc.
- Manual focus
- Driverless installation
- Supports Windows 7, Vista, XP



306429 / DA-71813
USB 2.0 HD Webcam

DIGITUS® USB „Tiny“ Webcam

Stay connected even on business trips und vacation

Highly compact design, space saving: for notebook and desktop use

- High-quality CMOS sensor with 1.3 Mega pixels
- Resolutions of up to 12 Mega pixels possible via software interpolation
- High-quality optical glass lens
- Manual focus settings, 8cm to infinity
- Automatic white balance and automatic exposure configurations
- Video capture with up to 30fps, MPEG4 format
- Built-in microphone
- Including functional utility software, easy to use
- USB 2.0 interface
- Driverless installation supported
- Supports Windows 7, Vista and XP

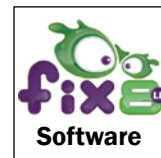

250333 / DA-70816
USB Webcam

USB 2.0 Wireless Webcam

Almost boundlessly! – Due to wireless transmission.

The USB 2.0 „plug and play“ Wireless Webcam with integrated microphone and CMOS image sensor with 300k pixels gives you an easy way to keep in contact with friends. etc. The USB dongle receives the wireless signal from the 2.4 GHz webcam which contains a built-in battery. After an operating time of 4-5 hours you can charge it via USB Port. With the „Snapshot“ button, you have the possibility to take your snapshots in seconds. By the automatic controlled LEDs, the webcam can be used even in low light conditions. Focus on a desired distance range, through the manual focus setting. The flexible universal mounting guarantees a solid hold on LCD monitors and on laptops as well. The Included Magician software allows you to edit your captured images by special effects, image frames, etc.

- 2.4G wireless webcam, 2-5 meter distance, with signal receiver
- High-quality CMOS sensor with 300k pixels
- Built-in microphone
- Driverless installation
- USB 2.0 interface
- „Snapshot“ - button for instant pictures
- Manual focus
- Rechargeable battery with power capacity for 4-5 working hours
- incl. IM Magician software for special effects, photo frames etc.
- Supports Windows 7, Vista, XP



306436 / DA-71814
USB 2.0 Wireless Webcam

USB 2.0 „Easy“ Webcam

High-quality CMOS sensor with 300k pixels

Internet webcam from Digitus with a 300K CMOS sensor and a maximum resolution of up to 1280x960. Additional the Easy Webcam has a built-in microphone. The flexible universal mounting guarantees a solid hold on LCD monitors and on laptops as well. With the „Snapshot“ button, you have the possibility to take your snapshots in seconds. Thanks to the driverless installation, you can use the webcam right away.

- Resolutions of up to 1.3 Mega pixels possible via software interpolation
- Built-in microphone
- USB 2.0 interface
- „Snapshot“ - button for instant pictures
- Multipurpose stand for laptops and LCD monitors
- Manual focus
- Driverless installation
- Supports Windows 7, Vista, XP



306290 / DA-71810
USB 2.0 „Easy“ Webcam

USB 2.0 „Trendy“ Webcam

High-quality CMOS sensor with 1.3 Mega pixels

The USB 2.0 „plug and play“ Webcam with integrated microphone and CMOS image sensor with 1.3 megapixels gives you an easy way to keep in contact with friends. With the „Snapshot“ button, you have the possibility to take your snapshots in seconds. By the automatic controlled LEDs, the webcam can be used even in low light conditions and a possible focus on a desired distance range, through the manual focus setting. The flexible universal mounting guarantees a solid hold on LCD monitors and on laptops as well. The Included Magican software allows you to edit your captured images by special effects, image frames, etc.

- Resolutions of up to 5 Mega pixels possible via software interpolation
- Built-in microphone
- USB 2.0 interface
- „Snapshot“ - button for instant pictures
- 3 automatic controlled LEDs for bad light conditions
- incl. IM Magican software for special effects, photo frames etc.
- Manual focus
- Driverless installation
- Supports Windows 7, Vista, XP



306405 / DA-71811
USB 2.0 „Trendy“ Webcam



*Enjoy connections.
Live.*

DIGITUS® USB Autofocus Microscope Camera

Bring small things sharp and crisp on the computers monitor

The USB-powered DIGITUS® USB Microscope lets you zoom in (from 50x to 170x) on any object you want to show. Thanks to its accompanying software you can record your findings as photos and videos on your PC. Hold it like a pen or pop it on the desktop stand. Its equipped with 8 bright white LEDs to illuminate objects to the optimal brightness and contrast. The highly sophisticated DIGITUS® USB Microscope offers loads of serious applications for business and hobby purposes, e.g. for industrial inspections of textiles and hard copy printouts, for testings of the skin or of other surfaces, for collectors of stamps, coins, gems and for science and education purposes. It is also usable as a reading aid.

- Universal Autofocus USB microscope camera for the PC
- Optic with seven glass lenses ensures sharp pictures
- Magnifying ratio 50-170x continuously variable
- Optical Autofocus system
- 1.3 Mega pixels (1/4 inch) image sensor
- Easy manual zoom control
- Cable remote control for snapshot and LED brightness
- Heavy Metal Stand
- Video capture and still image resolution up to 1280x1024 pixels
- Frame rate up to 30 fps
- Color depth: 24bit RGB
- Automatic white balance and exposure
- Light Source: 8 bright white LEDs (switchable/adjustable)
- Incl. Image Editing and Measurement Software
- USB 2.0 interface, bus powered
- Supports Windows 7, Vista and XP

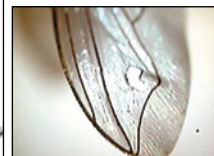

284123 / DA-70352

USB Autofocus Microscope Camera

DIGITUS® USB Microscope Camera

Bring small things really big on the computers monitor

The USB-powered DIGITUS® USB Microscope lets you zoom in (from 10x to 230x) on any object you want to show. Thanks to its accompanying software you can record your findings as photos and videos on your PC. Hold it like a pen or pop it on the desktop stand. It's equipped with 8 bright white LEDs to illuminate objects to the optimal brightness and contrast. The highly sophisticated DIGITUS® USB Microscope offers loads of serious applications for business and hobby purposes, e.g. for industrial inspections of textiles and hard copy printouts, for testings of the skin or of other surfaces, for collectors of stamps, coins, gems and for science and education purposes. Also usable as a reading aid.

- Universal USB microscope camera for computers
- Magnifying ratio 10-230x
- Frame rate max. 30 fps under 600 lux Brightness
- 1.3 Mega pixels (1/3.25") image sensor
- Manual focus from 10mm to infinite
- Video capture resolution: 1280x1024, 640x480, 320x240 pixels
- Still image capture resolution up to 1280x1024 pixels
- Color depth: 24bit RGB
- Shutter Speed: 1 sec to 1 / 1000 sec.
- Supports AVI video format
- Automatic white balance and exposure
- Light Source: 8 bright white LEDs (switchable/adjustable)
- Incl. Image Editing and Measurement Software
- USB 2.0 interface
- Supports Windows 7, Vista and XP



283904 / DA-70351

USB Microscope Camera



DIGITUS® High resolution video grabber

Copies old VHS tapes to DVD and CD

Getting rid of your old VHS tapes and preserving your treasurable home videos!! The new generation USB 2.0 Audio/Video grabber is the bridge between your computer and an analog camera, VCR, camcorder, DVD player or any other video sources. It converts analog video sources to digital format, now you can create VCD or DVDs of TV program, movies or videos from your camcorder / VCR in real time. The editing function enables you to create professional quality video. The burning function enables you to save your video clips as DVD or VCD.

- High speed USB 2.0 data transfer rate for superior audio/video recording
- Encoding MPEG1/MPEG2 and other formats directly, Ideal formats for video application
- Up to 25 fps motion capture capability at 720x576(PAL) & 30 fps at 720x480(NTSC)
- Composite, S-Video analog input, NTSC and PAL multi system support
- Video input: One RCA composite, One S-Video
- Audio input: For Windows XP and Vista, goes through USB; For Windows 2000, goes through sound card

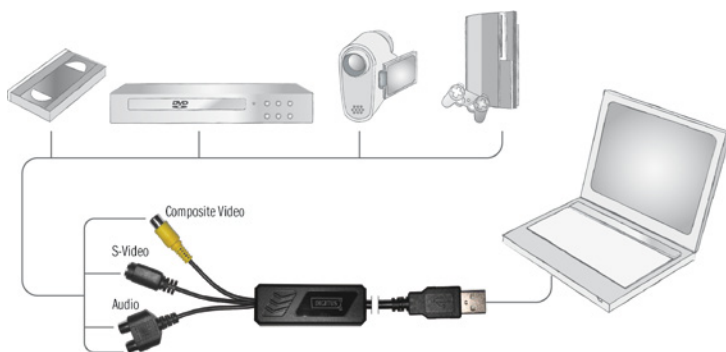

266112 / DA-70820-1

Highres video grabber

DIGITUS® USB 2.0 DVB-T HDTV Receiver Stick



Enjoy TV where you want and stay connected to your digital entertainment on-the-go

The portable DVB-T receiver with USB2.0 interface is designed especially for notebooks. The mini size DVB-T receiver does not require an additional external electricity supply and, after the attachment of an antenna, transforms a PC or notebook into a receiver for digital, terrestrial television. In addition to the rendering of TV programs the USB mini receiver has also extensive video recorder functions.

- Compliant with USB Audio Device Class Specification v1.0
- Plug and play, no additional driver needed
- Stereo speakers directly supported
- 16-bit audio DAC amplifier
- 16-bit ADC input with microphone boost
- LEDs indicating work status
- Supports Windows 7, Vista, XP and Mac OS 10.x



300878 / DA-70783-1

USB2.0 DVB-T HDTV Receiver Stick

DIGITUS® 7.1 USB Sound Box



Enjoy real multi-channel surround sound by only one simple USB connection

Full-duplex playback and recording

- Compliant to USB audio device class spec. 1.0 and USB HID class spec. 1.1
- Support 48/44.1 KHz sampling rate for both playback and recording
- 7.1 Surround speaker connection
- 3.5mm jack connectors
- S/PDIF optical digital in- and output
- USB 2.0 compliant
- Supports Windows 7, Vista and XP



276494 / DA-70800

7.1 USB Sound Box

DIGITUS® USB 2.0 audio adapter



Mind blowing sound in a device the size of a USB Stick

Compliant with USB specifications 2.0

- Compliant with USB Audio Device Class Specification v1.0
- Plug and play, no additional driver needed
- Stereo speakers directly supported
- 16-bit audio DAC amplifier
- 16-bit ADC input with microphone boost
- LEDs indicating work status
- Supports Windows 7, Vista, XP and Mac OS 10.x



233879 / DA-70777

USB 2.0 audio adapter

DIGITUS® Graphic Adapter, USB 2.0 to VGA

Connect 2 or more monitors/projectors to your computer, USB 2.0 to VGA

This USB to GVA Adapter enables you to connect one more monitor, LCD or projector to a computer with a USB 2.0 port. For desktop users adding an extra monitor via USB connection is easier than ever without having to open the computer chassis to install an internal video card. Once the installation is done, the USB-attached monitor soon wakes up. No function key hassle to swap a second monitor.

- Extends your desktop workspace (Dual Display); add-on monitor, TV or projector via USB
- Compliant with USB specifications 2.0
- User-friendly application: screen rotation, multi-display management, smart monitor ID detection (EDID)
- Supports multiple display modes on one PC: Primary, Extended, Mirror
- Up to 6 graphic adapter simultaneously for PC, and 4 for Mac
- Resolution up to 1920X1080 Full HD
- Display memory: 8MB SDRAM
- Video streaming is supported up to 1080p
- Color depth up to 32 bit
- USB bus powered
- Supports Direct X 3D computing accelerator
- Compliant with latest ATI & nVidia Graphic computing
- Supports Windows 7/Vista/ XP/2000, Mac OS X and Linux (OS Ubuntu)

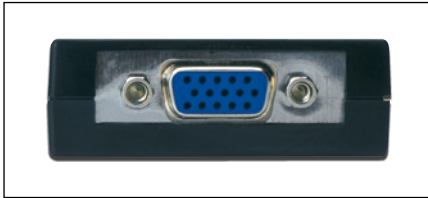

299837 / DA-70833
Graphic Adapter, USB 2.0 to VGA

USB 3.0 to VGA Adapter

One computer - up to 6 display devices - no extra video cards

The USB 3.0 Display Adapter is a device which enables connection to second display device to a computer using USB 3.0 port. With this convenient design, it can connect up to 6 display devices to a computer without installing extra video cards. Once the driver has been installed, the USB attached monitor will be enabled immediately. No function key on the adapter and there is no need to reboot the operating system after unplugging the USB adapter. System performance is an important issue when using multiple monitors. Another benefit of this adapter is that it occupies little computer resource; ensuring users get quality display without comprising computer performance.

- Extends your desktop workspace (Dual Display); add-on monitor, TV or projector via USB
- Compliant with USB specifications 3.0
- Supports multiple display modes on one PC: Primary, Extended, Mirror
- User-friendly application: screen rotation, multi-display management, smart monitor ID detection (EDID)
- Up to 6 graphic adapter simultaneously for PC
- Add or remove monitor without system reboot
- Supports High Resolution up to 2048x1152
- Video streaming is supported up to 1080p
- USB bus powered
- Resumes from hibernation and suspend modes
- Supports Windows 7, Vista and XP



311058 / DA-70450
USB 3.0 to VGA Adapter

DIGITUS® Graphic Adapter, USB 2.0 to DVI

Connect 2 or more monitors/projectors to your computer, USB 2.0 to DVI, (Full HD)

This USB to DVI Adapter enables you to connect one more monitor, LCD or projector to a computer with a USB 2.0 port. For desktop users adding an extra monitor via USB connection is easier than ever without having to open the computer chassis to install an internal video card. Once the installation is done, the USB-attached monitor soon wakes up. No function key hassle to swap a second monitor.

- Extends your desktop workspace (Dual Display); add-on monitor, TV or projector via USB
- User-friendly application: screen rotation, multi-display management, smart monitor ID detection (EDID)
- Compliant with USB specifications 2.0
- Supports multiple display modes on one PC: Primary, Extended, Mirror
- Up to 6 graphic adapter simultaneously for PC, and 4 for Mac
- Display memory : 8MB SDRAM
- Resolution up to 1920X1080 Full HD
- Video streaming is supported up to 1080p
- Color depth up to 32 bit
- USB bus powered
- Supports Direct X 3D computing accelerator
- Compliant with latest ATI & nVidia Graphic computing
- Supports Windows 7/Vista/ XP/2000, Mac OS X and Linux (OS Ubuntu)



299899 / DA-70834
Graphic Adapter, USB 2.0 to DVI

USB 3.0 to DVI Adapter

One computer - up to 6 display devices - no extra video cards

The USB 3.0 Display Adapter is a device which enables connection to second display device to a computer using USB 3.0 port. With this convenient design, it can connect up to 6 display devices to a computer without installing extra video cards. Once the driver has been installed, the USB attached monitor will be enabled immediately. No function key on the adapter and there is no need to reboot the operating system after unplugging the USB adapter. System performance is an important issue when using multiple monitors. Another benefit of this adapter is that it occupies little computer resource; ensuring users get quality display without comprising computer performance.

- Extends your desktop workspace (Dual Display); add-on monitor, TV or projector via USB
- Compliant with USB specifications 3.0
- Supports multiple display modes on one PC: Primary, Extended, Mirror
- User-friendly application: screen rotation, multi-display management, smart monitor ID detection (EDID)
- Up to 6 graphic adapter simultaneously for PC
- Add or remove monitor without system reboot
- Supports High Resolution up to 2048x1152
- Video streaming is supported up to 1080p
- USB bus powered
- Resumes from hibernation and suspend modes
- Supports Windows 7, Vista and XP



311065 / DA-70451
USB 3.0 to DVI Adapter

DIGITUS® USB 2.0 to HDMI Video Adapter



Connect 2 or more monitors/projectors to your computer, USB 2.0 to HDMI, Full HD

This USB to HDMI Adapter enables you to connect one more monitor, LCD or projector to a computer with a USB 2.0 port. For desktop users adding an extra monitor via USB connection is easier than ever without having to open the computer chassis to install an internal video card. Once the installation is done, the USB-attached monitor soon wakes up. No function key hassle to swap a second monitor.

- Extends your desktop workspace (Dual Display); add-on monitor, TV or projector via USB
- User-friendly application: screen rotation, multi-display management, smart monitor ID detection (EDID)
- Supports multiple display modes on one PC: Primary, Extended, Mirror
- HDMI output interface (Video & Audio)
- Fit-to-TV function, solving TV over-scan issue
- Display memory : 8MB SDRAM
- Resolution up to 1920X1080 Full HD
- Color depth up to 32 bit
- Up to 6 graphic adapter simultaneously for PC, and 4 for Mac
- Supports Direct X 3D computing accelerator
- Compliant with latest ATI & nVidia Graphic computing
- Support Window 7/ Vista/ XP, and Mac OS above 10.5.8



299974 / DA-70851
USB to HDMI video adapter

USB 3.0 to HDMI Adapter

One computer - up to 6 display devices - no extra video cards

The USB 3.0 Display Adapter is a device which enables connection to second display device to a computer using USB 3.0 port. With this convenient design, it can connect up to 6 display devices to a computer without installing extra video cards. Once the driver has been installed, the USB attached monitor will be enabled immediately. No function key on the adapter and there is no need to reboot the operating system after unplugging the USB adapter. System performance is an important issue when using multiple monitors. Another benefit of this adapter is that it occupies little computer resource; ensuring users get quality display without comprising computer performance.

- Extends your desktop workspace (Dual Display); add-on monitor, TV or projector via USB
- Compliant with USB specifications 3.0
- Supports multiple display modes on one PC: Primary, Extended, Mirror
- User-friendly application: screen rotation, multi-display management, smart monitor ID detection (EDID)
- Up to 6 graphic adapter simultaneously for PC
- Add or remove monitor without system reboot
- Supports High Resolution up to 2048x1152
- Video streaming is supported up to 1080p
- USB bus powered
- Resumes from hibernation and suspend modes
- Supports Windows 7, Vista and XP



311089 / DA-70452
USB 3.0 to HDMI Adapter

DIGITUS® Stereo speaker set 360W PMPO



The full range of sound in a space saving speaker system

Stereo multimedia speaker set

- Music power: 6W maximum in total
- Front side access: power on / off, volume control, and LED indicator
- Magnetically shielded headphone jack
- Speaker units: 2 x speakers, 3W each
- Frequency range: 80Hz - 18KHz
- Product dimensions: 81mm x 207mm x 81mm



190066 / DA-10240

Stereo multimedia speaker set 360W PMPO

DIGITUS® 2.1 Mini sub-woofer sound system

The ideal, powerful and compact audio solution for the PC!

2.1 Multimedia speaker

- Sub-woofer in wooden case
- Magnetic shielded
- Total output power: 16 Watts
- Volume and Bass control on front panel
- Speaker driver unit: Woofer: speaker with 10W, Satellite: 2 x speakers à 3W
- Frequency response range: 30Hz-20KHz
- Product dimension: Woofer: 135mm x 193mm x 204mm, Satellite: 72mm x 71mm x 151mm
- Accessories: 3,5mm stereo plug connection cable



270911 / DA-10252

2.1 Mini sub-woofer sound system



DIGITUS® „Super Bass“ Portable Speaker



Entertainment to go!

This high quality portable speaker enables you to enjoy your favourite music anywhere and anytime! Just simply connect your PC, laptop, MP3 player, ipod/iphone/ipad, smartphone or phone to the speaker and you're ready to go. Low-frequency enhancement and anti-breaking sound's technology provide excellent performance. Moreover, the speaker is based on a patented sound technology and on a special acoustic design structure which uses air compression to boost sound quality. With this, the product is able to produce sound at the highest volume without any or with very little distortion, while maintaining music quality at the lowest volume.

- Single-channel portable speaker
- Supports low-frequency enhancement technology (LFE)
- Provides anti-breaking sound system
- 3.7V working voltage, built-in Lithium battery (400mAh)
- Frequency range: 60Hz - 18KHz
- Charging function via Mini USB cable, 5V charging voltage
- With AUX 3.5mm jack
- Recharging voltage: 5V
- Horn specifications: 40mm 2.6Ω 3W
- SNR (Signal to Noise Ratio): ≥95dB
- Distortion degree: ≤0.5%
- Size: 60mm x 60mm x 50mm



306504 / DA-10285
„Super Bass“ Portable Speaker

DIGITUS® Stereo HQ In-Earphone, White



Provides comfort and a balance sound

Including three different sizes of soft silicon cushions: keep you for a perfect fit, superior comfort and an effective shield from external noise.

- 3,5mm stereo Plug, cable length: 120cm
- 10mm speaker diameter
- Frequency range: 20Hz - 20KHz
- Magnet type: neodymium
- Impedance: 24Ω±15%
- Sensitivity: 99±3dB / S.P.L. 1mW @ 1KHz
- Rated Input Power: 1mW
- Max. Input Power: 3mW



297697 / DA-10232
Stereo HQ In-Earphone



DIGITUS® Stereo Earphone Set



Enjoy your music wherever you go

Soft neck strap: feel free when hanging on the neck

- Direct connectable to any audio device with 3.5mm audio jack
- 3,5mm stereo plug, connection cable length: 60cm
- Speaker membrane diameter 15mm
- Frequency range: 20Hz - 20000Hz
- Magnet type: NdFeB
- Impedance: 32 Ohm
- Sensitivity: 100dB +/- 3dB
- Max. input power: 3mW



278832 / DA-10229
Stereo Earphone Set

186236 / DA-10224
Earphone - set, black

DIGITUS® iPhone® BeamJack™

4 in 1

- Use as additional-battery
- Dia-Show
- Cinema
- Presentations



Present
your Business
with the smallest-
Snap-on Techno-
logy!

Smallest Snap-On technology, cinema at its most!

The super-small and lightweight projector enables projections on indoor and outdoor surfaces. With a projection-distance of up to 3 meters, it is the smallest and most efficient device of its category.

The projector is just a tiny bit bigger as an iPhone 4/4S and therefore allows „in-between“ cinema experiences during journeys, at friends` or at home. Just simply plug your iPhone 4/4S on the dock-connector and you`re ready to start. The devices synchronize automatically. Your photos and movies, blockbuster or YouTube-videos can be played anytime and everywhere.

With a play time of up to 3 hours, the movies can be played uninterruptibly - the only thing you need is a free surface. The DIGITUS BeamJack leaves a very good impression even in the field of business! With the small and compact measurements, as well as the innovative snap-on technology, you`re always properly prepared for your presentations. The BeamJack is small and lightweight, so that it can be carried along each and every day. Moreover, it allows your PowerPoint presentations to become an optimal performance in the next meeting. With adequate apps, the DIGITUS BeamJack becomes ready for business!

For comfortable presentations of PowerPoint files, we recommend the applications `Dropbox` and `Presentation Viewer`, which can be downloaded for free in the Apple App store. In the following, we would like to give you an overview of the applications. Dropbox - have your documents, videos and photos always at hand! Dropbox is a free service, which saves and synchronizes your

data online. With that, the stored documents can always be accessed. The Dropbox enables direct access to your data from everywhere, equally in the office, at home or on the way. Dropbox is amongst others available for the Apple iPhone as well as for Mac and Windows systems.

Presentation Viewer - Show your PowerPoint presentations on the Apple iPhone! With the Presentation Viewer, PowerPoint presentations can be converted, so that they can be directly accessed via the Apple iPhone to be presented with the DIGITUS BeamJack.

- Projects 50 inch-pictures and videos from your iPhone 4/ 4S onto a free surface with a resolution of 640x360 pixel
- High-quality performance and brightness thanks to 15-lumen-LED projection
- Aspect Ratio: 16:9, 15 lumen
- Projection distance: 48.0 cm to 3.0 m
- Projector rechargeable via USB
- Integrated Li-polymer battery with charging function (2100mAh) for iPhone 4 / 4S
- Provides additionalcharge feature for the iPhone
- Offers up to 3 hours play time
- Integrated 0.5 watt speaker for perfect sound
- Integrated focus wheel and volume control- buttons
- Charging time: approx. 4 hours
- Incl. USB-Charger Cable
- Size: 12.7cm x 6.3cm x 2.2cm
- Weight: 105g



DIGITUS® USB Mini Car Charger

Tiny USB car power adapter - charges all devices with a USB cable or USB charging socket

Whether you need to charge your iPhone, cell phone or MP3 player, this adapter will power up your electronic devices in no time. Compact and convenient, an LED light comes on to notify you when your device is charging.

- Compact size
- Compatible with most electronic devices with a USB port
- Suitable to any vehicle's cigarette socket
- Suitable for charging mobile, MP3 Players, iPod, iPhone, PDA, etc.
- Low profile, which doesn't disturb the usage of surface.
- Finger puller to remove the device easily
- LED indicator
- Input: 12-24V
- Output: 5V/1A



288381 / DA-11001
USB Car Charger Mini Type

Micro USB charging cable incl. USB hub

Charge your device conveniently without losing the USB port

The DIGITUS Micro USB charging cable incl. USB hub enables you to charge your smartphone, phone, MP3 player etc. conveniently and offers an additional USB hub. With this, you can use your USB port simultaneously for other needs.

- Charging function for smartphones, phones, MP3 players etc. via Micro USB port
- Provides one additional USB hub
- Maximum data transfer rate 480Mbps (USB 2.0)
- USB 2.0 compliant
- Supports Windows 7, Vista, XP, Mac OS X and Linux



308492 / DA-70218
Mobility charging cable incl. USB hub

DIGITUS® USB Charging Adapter

The tiny and simple solution to charge your devices!

The DIGITUS® charging adapter allows you to charge your devices via PC, which normally cannot be charged directly via the PC's USB power. Its small-sized and simple design simplifies the charging process and ensures convenient usage.

- USB 2.0 compliant
- USB A Male / USB A Female
- Supports Windows 7, Vista, XP, Mac OS X and Linux



306498 / DA-11003
USB Charging Adapter, black

306672 / DA-11004
USB Charging Adapter, white

iPod® Car Charger Kit



All about charging on the trip

Universal Apple iPod®/iPhone®/iPod® connection set to charge over the USB car charging adapter or for synchronisation with the computer.

- Set consisting of an Apple Dock sync / charger cable, 1.0 m in white and a car adapter in white, for power supply over the car cigarette lighter socket.
- LED power indicator
- Input voltage DC 10,5 -18V
- Output voltage: DC 5V
- Charge rate: 2.1A
- Fuse: 2A 250V



293743 / DB-600900-010-W
iPod® Car Charger Kit incl. Sync/Charger cable, 1.0m

Charger Kit

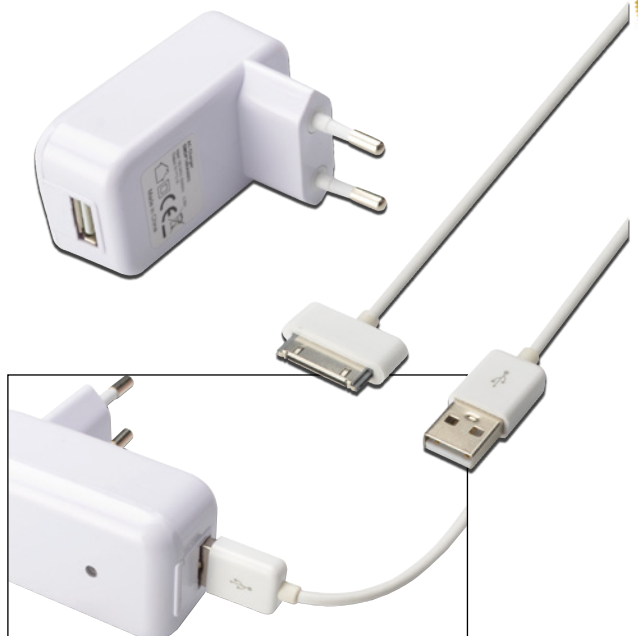

LED Indicator for charging process

This compact, universal Apple iPod® / iPhone® / iPod® USB Power Adapter Set enable a fast, efficient charging at home, office or on the go.

- Set consisting of an Apple Dock sync / charger cable, 1.0 m in white and a power adapter in white.
- LED power indicator
- Input voltage: 100-240V AC, 50/60Hz
- Output voltage: DC 5V
- Charge rate: 2.1A



305927 / DB-600901-010-W
iPod® Charger Kit incl. Sync/Charger cable, 1.0m

iPod® Adapter Battery Pack



Your back-up power source

Ideally for the lengthening of the accumulator from iPod® or iPhone®, e.g., during trekking / travelling tours, while using a Navi or MP3 player. To charge the battery pack you, can connect the battery with the included USB A/M - miniB(5pin)/M cable to a PC or notebook.

- Battery type: Li-Pol
- Capacity: 1500mAh
- Output: DC5V/500mA
- Load cycle: >1000
- Measurements: 61(L)*45.5(W)*13(H)mm



293910 / DB-600500-000-W
iPod® Adapter Battery Pack incl. Sync/Charger cable, 1.0m

Mobility charging cable incl. USB hub



Charge your Apple® device conveniently without losing the USB port

The DIGITUS Apple® mobility charging cable incl. USB hub enables you to charge your iPad, iPhone and iPod via the USB port and offers one additional USB hub. With this, you can use the USB port simultaneously for other needs.

- Charging function for iPad, iPhone & iPod
- Provides one additional USB hub
- Maximum data transfer rate 480Mbps (USB 2.0)
- USB 2.0 compliant
- Supports Windows 7, Vista, XP, Mac OS X and Linux



308508 / DA-70219
Mobility charging cable incl. USB hub

iPod® USB Sync/Charger cable



Anywhere and by-the-way synchronization and charging

Ideally to synchronise and charge an Apple iPod®, iPhone® or iPad® over the computer or for charging over any USB battery charger.

- For connection to a computer, laptop or appropriate power supply with USB port A
- For data transfer of, for example, music editing programs such as iTunes or suitable as a USB cable for charging over suitable power supplies



293712 / DB-600100-003-S
iPod® USB Sync/Charger cable, 0.25m

USB Sync/Charger cable



Anywhere and by-the-way synchronization and charging

Ideally to synchronise and charge an Apple iPod®, iPhone® or iPad® over the computer or for charging over any USB battery charger.

- For connection to a computer, laptop or appropriate power supply with USB port A
- For data transfer of, for example, music editing programs such as iTunes or suitable as a USB cable for charging over suitable power supplies
- UL certified
- plastic hood
- Double shielded
- AWG 30
- wire material cu
- surface nickel plated
- color connector white
- color cable white



293729 / DB-600100-005-W
iPod® USB Sync/Charger cable, 0.5m

293835 / DB-600100-010-W
iPod® USB Sync/Charger cable, 1.0m

iPod® Component with USB Audio/Video Cable

Present your fotos and videos easily on a screen;

Ideally to connect an Apple iPod®, iPhone® or iPad® over the component video plugs (RCA) with a television or a HiFi-system. Beyond that, with the USB plug you have the opportunity to charge the devices over an USB battery charger or computer, with concurrent audio/video-playback.

- UL certified
- plastic hood
- Double shielded
- AWG 30
- wire material cu
- surface nickel plated
- color cable white
- color connector white



293736 / DB-600101-015-W
iPod® Component with USB Audio/Video Cable, 1.5m

Micro USB adapter



Now loading Apple i-Devices with standard Micro USB charger cables!

This Apple iPod® / iPhone® / iPad® adapter allows you to exchange data and battery charging via Micro USB interface.

- Connector 1 Apple dock, plug
- Connector 2 Micro USB B, jack
- UL certified UL20276
- Hoods plastic
- Shielding single shielding
- Connector surface nickel-plated
- Color connector black



307501 / DB-600501-000-S
iPod® Micro USB adapter

3.5mm stereo with USB Audio Cable



Easy listening to your music over PC or Hi Fi-System

With this Apple audio and charging cable, you can hear music from an iPod®, iPhone® or iPad®, for example over your home stereosystem, a radio with 3.5mm stereo input jack or a car radio. Via the USB port your device can be charged and synced with a PC.

- Connector 1 Apple dock, plug
- Connector 2 3.5mm stereo, plug + USB A, plug
- UL certified UL20276
- Hoods plastic
- Shielding single shielding
- AWG 30
- Wire material CU
- Connector surface nickel-plated
- Color cable black
- Color connector black
- Length 0.5 m



307495 / DB-600102-005-S
iPod® 3.5mm stereo with USB Audio Cable, 0.5m

Micro USB adapter



Now loading Apple i-Devices with standard Micro USB charger cables!

This Apple iPod® / iPhone® / iPad® adapter allows you to exchange data and battery charging via Micro USB interface.

- Connector 1 Apple dock, plug
- Connector 2 Micro USB B, jack
- UL certified UL20276
- Hoods plastic
- Shielding single shielding
- Connector surface nickel-plated
- Color connector white



305880 / DB-600501-000-W
iPod® Micro USB adapter

3.5mm stereo with USB Audio Cable



Easy listening to your music over PC or Hi Fi-System

With this Apple audio and charging cable, you can hear music from an iPod®, iPhone® or iPad®, for example over your home stereosystem, a radio with 3.5mm stereo input jack or a car radio. Via the USB port your device can be charged and synced with a PC.

- Connector 1 Apple dock, plug
- Connector 2 3.5mm stereo, plug + USB A, plug
- UL certified UL20276
- Hoods plastic
- Shielding double shielding
- AWG 30
- Wire material CU
- Connector surface nickel-plated
- Color cable white
- Color connector white
- Length 1.5 m



305903 / DB-600102-015-W
iPod® 3.5mm stereo with USB Audio/Video Cable, 1.5m

Gaming Joystick

This Joystick gives you the ultimate control over any game with a virtual joystick

Do you miss your gaming console? This product gives you the feeling of an analog joystick. And transforms your Tablet PC into a mobile gaming console. So you have much more precision in your games and can not miss the area of control. Once the display is lit, melts the DIGITUS Gaming Joystick as a unit on your Tablet PC and is almost invisible, so you will never miss any action on the screen.

- Auto-centering for maximum control over your game
- Transparent design provides an unrestricted view of all the incoming action
- Quick and easy suction cup attachment
- Manufactured from an incredibly tough, but still flexible resin



310433 / DA-70071
Gaming Joystick

GameKeys

Add real physical joysticks to your touchscreen-devices for enhanced gaming precision

The perfect solution for your Tablet PC / Smartphone to transform it to a mobile game console. Place the „iKey“ with the suction cups on your Tablet PC / Smartphone, launch your favorite game and break your highscores!

- Removable and re-positionable
- Works with thousands of different games
- No damaging of the touchscreen



310358 / DA-70070
Game Keys

DIGITUS® Bluetooth 2.0 EDR tiny USB adapter



Bluetooth specification 2.0 + EDR (up to 3Mbps)

- Communicates with all standard Bluetooth devices
- USB bus powered
- Class 2, up to 10 m distance



271970 / DN-3020-2
Bluetooth 2.0 EDR tiny USB adapter

DIGITUS® Bluetooth 2.1 tiny USB adapter



Plug and forget - No need to unplug

Bluetooth specification 2.1 + EDR (up to 3Mbps)

- Class 2, up to 10 m distance
- Communicates with all standard Bluetooth devices
- System Requirements: PC compatible computer with USB 1.1 / USB 2.0 support, Microsoft Windows 7, Vista, XP
- The following services are supported: AV (A2DP, AVCTP, AVRCP, GAVDP), BIP, DUN, FAX, FTP, HCRP, HID, HS (with GAP), OPP, PAN, SDP, SPP, SYNC



285335 / DN-3021-1
Bluetooth 2.1 tiny USB adapter

DIGITUS® Bluetooth 3.0 tiny USB adapter



The small design provides plug-in and leave-in convenience for great usability

Bluetooth specification 3.0

- Class 2, up to 10 m distance
- Communicates with all standard Bluetooth devices
- System Requirements: PC compatible computer with USB 1.1 / USB 2.0 support, Microsoft Windows 7, Vista, XP



285342 / DN-30200
Bluetooth 3.0 tiny USB adapter

DIGITUS® Bluetooth 4.0 tiny USB adapter



The small design provides plug-in and leave-in convenience for great usability

Bluetooth specification 3.0

- Ultra low Power Consumption
- Class 2, up to 10 m distance
- Communicates with all standard Bluetooth devices
- System Requirements: PC compatible computer with USB 1.1 / USB 2.0 support, Microsoft Windows 7, Vista



285342 / DN-30210
Bluetooth 3.0 tiny USB adapter

DIGITUS® Stereo multimedia headset



Great sound for communication, music and games

- Closed stereo headphones, tightly resting on ears, including microphone
- Built-in volume control in cable
- Light-weight design and soft ear pads ensuring a high wearing comfort
- Cable length 1,8m, with volume control
- Dual 3,5mm stereo jack
- Frequency: 50Hz-3KHz over 70dB
- Impedance: 32 Ohm +/- 15%
- Sensitivity: 90dB +/- 3dB /mW
- Diameter of microphone: 9 x 7mm
- Microphone sensitivity: -52dB +/- 3dB
- Weight: 190g (earphone only)



291886 / DA-12200
Stereo multimedia headset

DIGITUS® Multimedia microphone with stand



Ideal for Podcast production and text-to-speech applications

- Compact multimedia microphone with stand, adjustable inclination angle
- Condenser microphone
 - Frequency range: 50Hz - 16000Hz
 - Sensitivity: -60dB +/- 3dB (0dB= 1V/μ BAR at 1KHz)
 - Operating voltage: 1V-10V (standard = 3V)
 - Cable length: 1,8m
 - Connector: 3.5mm, stereo plug
 - Weight: 90g



210566 / DA-10102
Multimedia microphone with stand



DIGITUS® Multimedia stereo headset with microphone



A PC headset for comfortable music listening and internet chat

- Stereo headset with microphone, manually adjustable
- Speakers: 30mm dynamic, impedance 320hm, sensitivity 101dB +/- 4dB, frequency range 100Hz-15000Hz, maximum input 100mW
 - Microphone: frequency range 50Hz-16000Hz, efficiency -62dB +/- 3dB, operating voltage 1V-10V (standard=3V)
 - Cable length: 1,8m
 - Connections: 2 x 3.5mm, stereo plugs
 - Weight: 125g



071808 / DA-10201
Stereo multimedia headset with microphone

DIGITUS® Multimedia microphone with stand



Ideal for Podcast production and text-to-speech applications

- Compact multimedia microphone with stand, adjustable inclination angle
- Condenser microphone
 - Frequency range: 50Hz - 16000Hz
 - Sensitivity: -60dB +/- 3dB (0dB= 1V/μ BAR at 1KHz)
 - Operating voltage: 1V-10V (standard = 3V)
 - Cable length: 1,8m
 - Connector: 3.5mm, stereo plug
 - Weight: 125g



101017 / DA-10101
Multimedia microphone with stand

DIGITUS® „Blueshine ZX“ Illuminated Multimedia Keyboard



From the home office to your living room, enjoy high style and a natural typing multimedia experience

Illuminated keyboard with Multimedia keys

- Letters light up in bright blue color
- Illumination controlled by a dedicated key
- Responsive low profile keys for superior typing comfort
- Eight additional keys to access and control applications and media
- Plug and Play installation – no additional software required
- USB connection cable length 130cm
- USB Type A plug
- Size: 401 x 162 x 25mm
- Supports Windows 7, Vista and XP



285281 / DA-20201

Blueshine ZX™ Illuminated Multimedia Keyboard

DIGITUS® „Black Line“ USB Keyboard



The convenient keyboard for home and office

Quiet and responsive keyboard with low-profile keys

- Integrated full-size number pad
- Eight additional keys to access and control applications and media
- Color black / silver
- Plug and Play installation – no additional software required
- USB connection cable length 130cm
- Standard 104 keys
- USB Type A plug
- Size: 458 x 157 x 23mm
- Supports Windows 7, Vista and XP



285236 / DA-20141

„Black Line“ USB Keyboard

DIGITUS® „Silver Line“ USB Multimedia Keyboard



The smart keyboard to control media

Quiet and responsive keyboard with low-profile keys

- Eight additional keys to access and control applications and media
- Color black / silver
- Plug and Play installation – no additional software required
- USB connection cable length 130cm
- USB Type A plug
- Size: 458 x 157 x 23mm
- Supports Windows 7, Vista and XP



285274 / DA-20146

„Silver Line“ USB Multimedia Keyboard

DIGITUS® Numeric Keyboard USB



Plug-and-go, with retractable USB cable. Ideal for travelers!

- Compliant with USB standards
- Plug and Play compatible
- Self powered by USB
- Retractable cable, 70cm
- LED indicator for activity
- Operating voltage 5V DC via the USB bus
- Dimension: 13,7 x 9,4 x 2,4 cm
- Supports Windows 7, Vista and XP



287599 / DA-20220-3

Numerische Tastatur USB

DIGITUS® High Performance Laser Mouse



performance laser mouse: adjustable weight cartridge and a sampling rate up to 5000dpi

Ergonomic design

- Sensitivity: Switchable 800dpi/ 1600dpi/ 3200dpi/ 5000dpi
- Laser sensor: can be used almost every surface, even on glass
- Rubber pad adds grips
- Weight tuning, up to 38g for your individual weight preferences
- LED indicator shows different dpi
- Customizable Buttons
- Power consumption: 5V, 100mA
- Cable length: 1.8m
- Supports Windows 7, Vista and XP
- Weight: 170g (Mouse itself) + additional Cartridge 38g



294382 / DA-20130

High Performance Mouse, Laser, 7 buttons

DIGITUS® Wireless Optical Ergonomic Mouse



More convenience and reliability with 2.4GHz wireless technology

Wireless 5-button optical mouse with scrolling wheel

- Switchable 800/1600dpi high resolution optical sensor, works on virtually any surface
- Powered by one usual standard AA battery
- Automatic power-off mode
- LED indicator for dpi switching and low-battery warning
- USB Nano receiver with reliable 2.4GHz technology, operating distance up to 10m
- Ergonomic shaped design with rubber coating for right-hander
- Additional buttons for dpi selection and page forward / backward
- Size: 11.6cm x 6.2cm x 3.8 cm
- Weight: 102g
- Supports Windows 7, Vista, XP and Mac OS 10.x



283829 / DA-20128

Wireless Optical Scroll Mouse

DIGITUS® Wireless Optical Mini Notebook Scroll Mouse



More precision and convenience than a notebook touchpad

Wireless 3-button optical mouse with scrolling wheel

- 800dpi high resolution optical sensor, works on virtually any surface
- Powered by one usual standard AAA battery
- Automatic power-off mode
- USB Nano receiver with reliable 2.4GHz technology, operating distance up to 10m
- Compact travel size with a comfortable contoured design suitable for right and left hand
- Size: 8.1cm x 4.9cm x 3cm (mouse)
- Weight: 80g
- Supports Windows 7, Vista, XP and Mac OS 10.x



285205 / DA-20129

Wireless Optical Notebook Scroll Mouse

DIGITUS® Optical Office Mouse



Quick and easy navigation with the convenient scroll wheel

Optical mouse with 3 buttons and a scrolling wheel

- 800dpi high resolution optical sensor
- Works on virtually any surface
- Ergonomic design for using with right or left hand
- USB A type connection
- Cable Length 1.5m
- Size: 11.6cm x 6.2cm x 3.8 cm
- Weight: 102g
- Supports Windows 7, Vista, XP and Mac OS 10.x



301776 / DA-20127-1

Optical Office Mouse, 3 button, USB

DIGITUS® 3 in 1 Notebook Protection Tab



No more scratched and soiled Notebook screens.
 3 functions: mouse pad+ microfiber screen cleaner + screen protecting from keyboard scratching

- Protects your sensitive notebook screen
- Usable as travel mousepad
- Suitable as a microfiber cleaning cloth
- Protected with AEGIS Microbe Shield™
- Non-slip rubber bottom gives strong grip
- Size: 280mm x 160mm x 1mm
- Material: MicroFiber + Nature Rubber
- Product is washable (hand wash)



288404 / DA-50132
3 in 1 Notebook protection Tab

DIGITUS® Mouse pads with wrist rest



This soft and flexible pad makes it easy to endure long hours at work or home computing

Ergonomically designed mouse pads

- Gel filled pad supporting the wrist
- Material : Polyester + PU +PU Gel
- Color: blue
- Dimensions (L x W x H): 225mm x 180mm x 3mm



104995 / DA-50122
blue
105008 / DA-50123
red

DIGITUS® Mouse pads, 3 mm thick



Prevents table surfaces from damage and scratches, suitable for ball and optical mice

Color: red

- Material : Polyester + EVA foam
- Dimensions (L x W x H): 250mm x 220mm x 3mm
- Logo printing and additional colors upon request



073222 / DA-50101
red, 250mm x 220mm x 3mm
073246 / DA-50102
blue, 250mm x 220mm x 3mm
073253 / DA-50103
green, 250mm x 220mm x 3mm
073260 / DA-50104
black, 250mm x 220mm x 3mm
073277 / DA-50105
gray, 250mm x 220mm x 3mm
202974 / DA-50131
black, 320mm x 265mm x 3mm

DIGITUS® Keyboard wrist rest

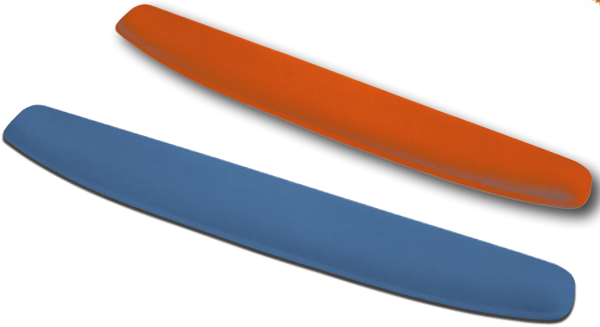

This soft and flexible pad makes it easy to endure long hours at work or home computing

Ergonomic, gel filled wrist rest to support the forearm during use of keyboard

- Material : Polyester + PU +PU Gel
- Color: blue
- Dimensions (L x W x H): 475mm x 80mm x 20mm



105015 / DA-50124
Blue
105022 / DA-50125
Red

DIGITUS® Dust Remover



Removes dust and lint in home or office

Blows dust and lint away from inaccessible areas of computer keyboards, printers, CD-ROM, disk drives, copiers, fax machines, etc.

- 400ml pover duster tin incl. small spray tube
- Variable spray intensity
- Eco-friendly, contains no CFC or HCFC

277781 / DA-50000
Dust Remover, 400ml

DIGITUS® Office cleaning wipes



Removes smudges, dirt, dust and fingerprints without scratching or leaving any residue behind

Special cleaning cloths for TFT screens, laptops and flat bed scanner screens; also suitable for use on PDA and LCD screens, screen-free filters and all treated and untreated glass surfaces eg. mirrors, microfilm reading screens, OHP screens and lenses as well as for all plastic and painted metall surfaces.

- Removes dust and dirt and provides streak free cleaning, rapid self-drying
- The liquid contains no alcohol (not flammable) and is free of Methanol

277804 / DA-50220
Office cleaning wipes

DIGITUS® Universal Office Cleaning Gel



Makes screens look brand new

Special cleaning gel for TFT, LCD, plasma screens and laptop displays plus any other sensitive plastic surface. Incl. microfibre tissue for polishing.

- Special cleaning gel for TFT/LCD, Plasma screens, laptops and any sensitive plastic surfaces
- Incl. microfibre tissue for polishing (capacity: 200ml)
- Streak-free cleaning

277798 / DA-50100
Universal Office Cleaning Gel, 200ml

DIGITUS® Office cleaning set



The complete cleaning solution for home and office

Multi-part universal office cleaning set for office, home and on the way

- 125ml aerosol tin with monitor & plastics cleaner for TFT, LCD, plasma screens and laptop displays plus any other sensitive plastic surface
- Incl. microfibre tissue for polishing & three sets wet & dry
- Cleaning cloths for TFT screens, laptops and flat bed scanner screens; also suitable for use on PDA and LCD screens, screen-free filters and all treated and untreated glass surfaces eg. mirrors, microfilm reading screens, OHP screens and lenses as well as for all plastic and painted metall surfaces.

277811 / DA-50300
Office cleaning set



DIGITUS® Office cleaning set



All needed utensils for cleaning of office equipment in one set!

Multi-part office cleaning set for all application fields. Contains cleaning accessories for TFT, LCD and other displays, for Scanner, copy machines, over head projectors, fax machines, printers, computer cases, keyboards, mouse units, telephones and other equipment.

- 125ml aerosol tin with monitor & plastics cleaner
- Incl. a microfiber cloth a universal cleaning sponge (blue), a keyboard cleaning sponge (grey) and three keyboard cleaning swabs
- The liquid contains no alcohol
- Not flammable
- Antistatic
- Contains fragrance

297383 / DA-50301
Office Cleaning set, 7 parts

DIGITUS® Display polish



For a perfect surface!

This polish paste removes easily scratches of plane surfaces as cell phone displays, watches, glasses, MP3 players, etc. User Instruction: 1. Tape the edge of the scratched surface 2. Use some polish paste with the cloth and polish the scratched areas for 2-3 minutes with pressure. Repeat the process on deep scratches.

- 5g tube incl. cleaning cloth
- For iPhone, iPad, iPod, MDA, Smartphone and others.

300106 / DA-50410
Display polish

DIGITUS® Wet & Dry - TFT / LCD Screen cleaner

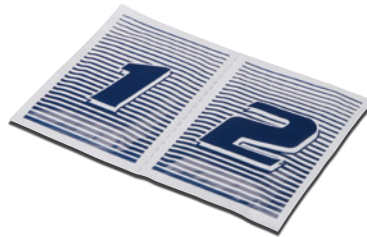

Perfect brilliant display surface!

Special cleaning cloths for all glass surfaces, TFT screens, laptops and flat bed scanner screens; also suitable for use on PDA and LCD screens, polarizing filter. The product removes dust and dirt and provides streak free cleaning.

- 10 sets Wet & Dry cleaning cloths
- The liquid contains no alcohol
- Not flammable
- Antistatic
- Contains fragrance

297376 / DA-50221
Display Cleaning cloths

DIGITUS® Display Cleaning set



Perfect and brilliant display surfaces!

Premium Display Cleaner (30ml) with high quality microfiber cloth for perfect cleaning of iPhones, iPads, iPods, other smartphones, MDAs, tablet PCs or even digital photo frames. Apply liquid to the microfiber cloth, clean the display and repolish dryly. - Fluid does not contain alcohol. Contains fragrance and antistatic agent. Non-smearing.



297192 / DA-50150
Display Cleaning set for Smartphones

DIGITUS® Lens cleaner for CD, DVD and Blu-ray



Extends the lifespan of laser players

To avoid reading errors and laser „skipping“, the laser lenses of CD/ DVD and Blu-ray drives should be cleaned regularly. This guarantees excellent sound and brilliant pictures for a long time. The DIGITUS laser lens cleaner cleans and removes dust, dirt and other deposits in one carefully controlled process.

297390 / DA-50400
Lens cleaner for CD, DVD and Blu-ray

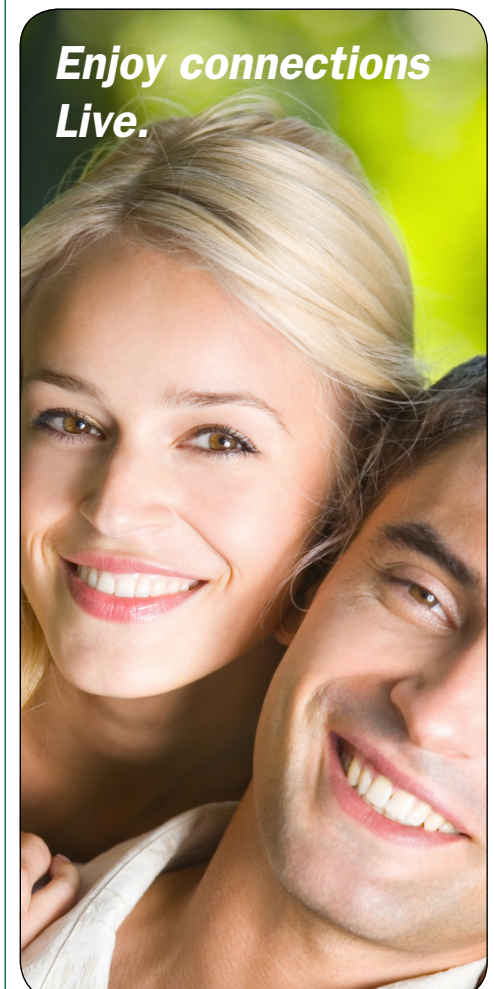

DIGITUS® USB3.0 Dual Docking Station

Instant storage access - ideal for back-up

Supports 2 x 3.5" or 2.5" SATA HDD plug-in one compact unit, data can be transfer between 2,5 and 3,5 SATA HDD

- One touch back-up function(Multi-language driver)
- Two hard drives can be read & write at the same time
- Support USB 3.0 SUPERSPEED max 5Gbps/ USB 2.0 HIGH-SPEED mode 480Mbps/USB 1.1FULL-SPEED 12Mbps
- Achieves transfer speeds of up to 200Mbps
- Hot swapping of connected devices supported
- Supports SATA 1.5Gbps /3.0Gbps Speed negotiation
- Supports 2TB HDD
- Supports Windows 7, Vista and XP



ohne Festplatten



287926 / DA-70547

USB 3.0 SATA Dual Docking Station

DIGITUS® Hard Disk USB 3.0 Cool Dock, for 2.5/3.5 HDDs

Shelter your precious memories

Support USB 3.0 to Serial ATA interface, transfer rate up to 5Gbps

- Supports 2.5/3.5 SATA HDD's
- Supports SATA, SATA II
- With one-touch backup function
- Built-In 80mm silent cooling fan
- Displays alarm exceed temperature setting
- LEDs indicate activity and data transmissions
- Plug and Play and Hot Plug
- Easy to install and remove the hard disk drives
- Power Supply (12V/2A) included
- Supports Windows 7, Vista and XP



287414 / DA-70546

USB 3.0 Cool Dock

DIGITUS® SATA USB 3.0 HDD Docking Station

Ultra fast access via USB 3.0 to external HDDs - just plug and work.

- Supports standard SATA HDD's 2.5 and 3.5
- USB 3.0 data transfer rate up to 5Gbps
- Simple and easy installation and use of HDD's
- Plug and Play and hot-swappable
- The hot swap capability ensures safe detachment of hard drive
- Supports HDDs up to 2TB capacity
- Power indicator LED
- Incl. USB 3.0 connection cable, manual and power supply
- Supports Windows 7, Vista and XP



287414 / DA-70546

USB 3.0 Cool Dock

DIGITUS® External HDD Enclosure 2.5, SATA to USB 3.0

Easy Installation, Screwless Design

The DIGITUS external HDD enclosure gives you the flexibility to use your ordinary HDD in a modern and compact case. Its easy to use design allows you to quickly install a 2.5 SATA HDD and enjoy all advantages of an external drive. Just open the case and plug in your HDD, no need to use screws. Furthermore the compact design makes it really handy to transport your favorite data and access it over a simple USB 3.0 cable in your PC.

- Screwless design, easy assembling a hard disk
- Modern image is shown by the shining polished surface
- Suitable for standard SATA hard disk 2.5
- Compliant to USB 3.0 specification, downward compatible with USB 2.0 High-Speed (480Mbps)
- USB 3.0 data transfer rate up to 5Gbps
- LED Indicators: Power (Red), Access (Blue)
- Supports hot-plugging, plug and play compliant
- USB bus powered
- Size: 13.5cm x 8.5cm x 1.5cm (LxWxH)
- Supports Windows 7, Vista and XP



297932 / DA-71030
External HDD enclosure 2.5, SATA to USB 3.0

DIGITUS® External HDD Enclosure 3.5, SATA to USB 3.0

Easy Installation, Screwless Design

The DIGITUS external HDD enclosure gives you the flexibility to use your ordinary HDD in a modern and compact case. Its easy to use design allows you to quickly install a 3.5 SATA HDD and enjoy all advantages of an external drive. Just open the case and plug in your HDD, no need to use screws. Furthermore the compact design makes it really handy to transport your favorite data and access it over a simple USB 3.0 cable in your PC.

- Screwless design, easy assembling a hard disk
- Modern image is shown by the shining polished surface
- Suitable for standard SATA hard disk 3.5
- Compliant to USB 3.0 specification, downward compatible with USB 2.0 High-Speed (480Mbps)
- USB 3.0 data transfer rate up to 5Gbps
- LED Indicators: Power (Red), Access (Blue)
- Supports hot-plugging, plug and play compliant
- Size: 19.6cm x 11.1cm x 3.5cm (LxWxH)
- Supports Windows 7, Vista and XP



297963 / DA-71035
External HDD Enclosure 3.5, SATA to USB 3.0

DIGITUS® USB 3.0 Hub, 4-port

Increased connection possibilities for the new generation of Super-Speed USB 3.0 peripherals

Supports Super-Speed USB (5Gbps) and High-Speed USB (480Mbps)

- Compliant to USB 3.0 specification, down compatible with USB 2.0 and USB 1.1
- 4xUSB A/F, 1xUSB A/F, Cable AM-AM 1.2M
- Over-current protection on all outputs
- Supports „Hot-plug“ and is „Plug and Play“ compatible
- Supports Windows 7, Vista, XP



292081 / DA-70230-1
USB 3.0 Hub, 4-port

DIGITUS® Card Reader All-in-one, USB 3.0

The fastest and easiest way to transfer digital images to your computer

The DIGITUS USB 3.0 „All-in-One“ Card Reader enables you to transfer your digital content to a PC or Mac in a very fast and easy way. The product gives you the ability to use nearly every type of memory card.

- Compliant to USB 3.0 specification, down compatible with USB 2.0 and USB 1.1
- Supports data transfer rate: Super-speed (5Gbps) / High-speed (480Mbps) / Full-speed (12Mbps) / Low-speed (1.5Mbps)
- Supports Media Copy and Hot-Swap
- Supports hot-plugging, plug and play compliant
- Supports the following memory card formats: Compact Flash (CF) series, Memory Stick (MS) + M2 series + MSXC + MSPRO-HC, Secure Digital (SD / SDHC) + mini SD + Micro SD (Trans-Flash), MMC, SDXC
- Bus powered - no external power supply necessary
- Supports Windows 2000/XP/Vista/7, Mac OS 10.X



300557 / DA-70330
Card Reader, USB 3.0, All-in-one

DIGITUS® USB 3.0 to SATA Adapter cable



Turns any SATA hard drive into an ultra fast external USB 3.0 drive - Ideal for backup and service

Supports 2,5/3,5 SATA HDD's

- Compatible to all SATA Standards
- Supports data transfer rate: Low-speed(1.5Mbps) / Full-speed(12Mbps) / High-speed(480Mbps) / Super-speed(5Gbps)
- Compliant to USB 3.0 specification, down compatible with USB 2.0 and USB 1.1
- Supports ATA/ATAPI Ultra DMA Mode
- Supports ATA/ATAPI PACKET command feature set
- USB Mass Storage Class support
- Plug and Play and hot-swappable
- High-speed data transfer, low power consumption
- Incl. power supply, Input: AC 100-240V, 50/60Hz, Output: DC 12V2A
- Supports Windows 7, Vista and XP



287919 / DA-70300
USB 3.0 to SATA II Adapter cable

DIGITUS® USB 3.0 to SATA III Adapter cable



Turns any SATA HDD / SSD into an ultra fast external USB 3.0 drive - Ideal for backup and service

- Supports 2,5/3,5 SATA HDD / SSD's
- Supports SATA 6.0Gbps / 3.0Gbps / 1.5Gbps Speed negotiation
- Supports data transfer rate: Super-speed(5Gbps) / High-speed(480Mbps) / Full-speed(12Mbps) / Low-speed(1.5Mbps)
- Compliant to USB 3.0 specification, down compatible with USB 2.0 and USB 1.1
- USB Mass Storage Class support
- Plug and Play and hot-swappable
- Compliant to Serial ATA3
- High-speed data transfer, low power consumption
- Incl. power supply, Input: AC 100-240V, 50/60Hz, Output: DC 12V2A
- 1.2M USB 3.0 to SATA III Cable
- Supports Windows 7, Vista, XP



308546 / DA-70326
USB 3.0 to SATA III Adapter cable

DIGITUS® USB 3.0 IDE & SATA Cable



Convert your SATA / IDE hard drive into an external USB drive - ideal for backup and service!

USB 3.0 adapter cable for fast and easy HDD connections - no external enclosure needed. Use any 2.5 / 3.5 IDE hard drive or SATA hard disk as an additional external hard drive. Ideal for service, maintenance, hassle-free temporary HDD access, e.g. for data backups and restore purposes.

- Supports 2.5/3.5 IDE and SATA HDDs
- Supported data transfer rates: Super-speed (5Gbps), High-speed (480Mbps), Full-speed (12Mbps) and Low-speed (1.5Mbps)
- Supports SATA 1.5Gbps / 3.0Gbps Speed negotiation
- Compliant to Universal Serial Bus 3.0 Specification, downwards compatible to USB 2.0, 1.1 Specification
- Compliance with USB Mass Storage Class
- Plug and Play and hot-swappable
- incl. Power Supply 12V/2A
- Compliant to Serial ATA2.6



306481 / DA-70325
USB 3.0 IDE & SATA Cable

DIGITUS® USB 3.0 Sharing Switch



The USB Sharing Switch allows to share a single USB device between two computers via USB 3.0 speed

USB 3.0 data transfer rate up to 5Gbps

- Compliant to USB 3.0 specification, down compatible with USB 2.0 and USB 1.1
- Selects PCs by using push buttons on top panel
- Connecting to computer by USB 3.0 B-Type port and connecting to device by USB3.0 A-Type
- High-speed data transfer, low power consumption
- USB Bus Powered, w/o Power Supply
- Two blue LEDs indicate selected PC
- Supports Windows 2000/XP/Vista/7, Mac OS 10.X



293262 / DA-73300
USB 3.0 Sharing Switch, 2 PCs - 1 device

DIGITUS® SATA DUAL HDD Docking Station



Supports fast and easy standalone HDD cloning by push button

The DIGITUS SATA DUAL HDD Docking Station supports standalone HDD cloning, which is able to copy data and system files from source HDD to target HDD completely via finger touch. The DIGITUS SATA DUAL HDD Docking Station provides fast, convenient access to 2.5 or 3.5 SATA or SATA II hard drive contents through either USB or eSATA, without ever having to open a computer case or mount hard drives in an enclosure.

- Integrated standalone HDD cloning function by push button
- Supports standard SATA HDD's 2.5 and 3.5
- Data transfer rate up to 480Mbps USB 2.0
- Compatible with SATA I, and SATA II data transfer speed up to 3Gbps
- With USB and eSATA connection ports
- Simple and easy installation and use of HDD's
- Plug and Play and hot-swappable
- The hot swap capability ensures safe detachment of hard drive
- Power indicator LED
- Incl. USB 2.0 A/M and eSATA cable, manual and power supply
- Supports Windows 7, Vista, XP, Mac OS X and Linux



282525 / DA-70544
SATA DUAL HDD Docking Station, eSATA and USB

DIGITUS® SATA HDD docking station



Easy and convenient way for data backup and recovery, hard drive testing, and fast access to archived hard drives

- Supports standard SATA HDD's 2.5 and 3.5
- Data transfer rate up to 480Mbps USB 2.0
- Simple and easy installation and use of HDD's
- Plug and Play and hot-swappable
- The hot swap capability ensures safe detachment of hard drive
- Power indicator LED
- Internal 2-port USB 2.0 HUB
- Incl. USB 2.0 A/M cable, manual and power supply
- Supports Windows 7, Vista, XP and Mac OS 10.x



292654 / DA-70541-1
SATA HDD docking station with USB hub, USB

DIGITUS® SATA HDD docking station



Easy and convenient way for data backup and recovery, hard drive testing, and fast access to archived hard drives

- Supports standard SATA HDD's 2.5 and 3.5
- Data transfer rate up to 480Mbps USB 2.0
- Compatible with SATA I, and SATA II data transfer speed up to 3Gbps
- With USB and eSATA connection ports
- The eSATA and USB port can be used at the same time
- Simple and easy installation and use of HDD's
- Plug and Play and hot-swappable
- The hot swap capability ensures safe detachment of hard drive
- Power indicator LED
- Internal 2-port USB 2.0 HUB
- Incl. USB 2.0 A/M and eSATA cable, manual and power supply
- Supports Windows 7, Vista, XP and Mac OS 10.x



292685 / DA-70542-1
SATA HDD docking station with USB hub, USB, eSATA

DIGITUS® 3.5 Hard Disk IDE to SATA Interface Converter



The convenient solution to further use your existing IDE hard disks

Ideal for further using your existing IDE hard disks e.g. in a new SATA enabled PC or in a SATA docking station

- Suitable for 3.5 IDE hard disks to be compliant with the SATA interface
- Easy to install: Simply „dock“ the converter to the 3.5 IDE hard disk and fix it by two screws, the HDD is now ready to connect to the SATA controller or a HDD docking station
- Closed metal-housing design for a hassle-free installation without cable clutter
- Supports SATA and SATA II standards with data transfer rate up to 1,5Gbps
- Supports ATA/ATAPI data transfer rates of 66, 100, 133 and 150MB/s
- SATA Plug and Play operation, no additional software needed
- Supports hard drives from Maxtor, Samsung, IBM, Hitachi, Seagate and Western Digital (adapter included)



283867 / DA-70545
3.5 Hard Disk IDE to SATA Interface Converter

DIGITUS® External HDD Enclosure 2.5, IDE to USB 2.0



Easy Installation, Screwless Design

The DIGITUS external HDD enclosure gives you the flexibility to use your ordinary HDD in a modern and compact case. Its easy to use design allows you to quickly install a 2.5 IDE HDD and enjoy all advantages of an external drive. Just open the case and plug in your HDD, no need to use screws. Furthermore the compact design makes it really handy to transport your favorite data and access it over a simple USB 2.0 cable in your PC.

- Screwless design, easy assembling a hard disk
- Modern image is shown by the shining polished surface
- Suitable for standard IDE hard disk 2.5
- Compliant to USB 2.0 specification
- Supports data transfer rates up to 480Mbps
- LED Indicators: Power (Red), Access (Blue)
- Supports hot-plugging, plug and play compliant
- USB bus powered
- Size: 13.5cm x 8.5cm x 1.5cm (LxWxH)
- Supports Windows 7, Vista, XP and Mac OS 10.x



297918 / DA-71001

External HDD enclosure 2.5, IDE to USB 2.0

DIGITUS® External HDD enclosure 2.5, SATA to USB 2.0



Easy Installation, Screwless Design

The DIGITUS external HDD enclosure gives you the flexibility to use your ordinary HDD in a modern and compact case. Its easy to use design allows you to quickly install a 2.5 SATA HDD and enjoy all advantages of an external drive. Just open the case and plug in your HDD, no need to use screws. Furthermore the compact design makes it really handy to transport your favorite data and access it over a simple USB 2.0 cable in your PC.

- Screwless design, easy assembling a hard disk
- Modern image is shown by the shining polished surface
- Suitable for standard SATA hard disk 2.5
- Compliant to USB 2.0 specification
- Supports data transfer rates up to 480Mbps
- LED Indicators: Power (Red), Access (Blue)
- Supports hot-plugging, plug and play compliant
- USB bus powered
- Size: 13.5cm x 8.5cm x 1.5cm (LxWxH)
- Supports Windows 7, Vista, XP and Mac OS 10.x



297925 / DA-71002

External HDD enclosure 2.5, SATA to USB 2.0

DIGITUS® External HDD Enclosure 3.5, IDE to USB 2.0



Easy Installation, Screwless Design

The DIGITUS external HDD enclosure gives you the flexibility to use your ordinary HDD in a modern and compact case. Its easy to use design allows you to quickly install a 3.5 IDE HDD and enjoy all advantages of an external drive. Just open the case and plug in your HDD, no need to use screws. Furthermore the compact design makes it really handy to transport your favorite data and access it over a simple USB 2.0 cable in your PC.

- Screwless design, easy assembling a hard disk
- Modern image is shown by the shining polished surface
- Suitable for standard IDE hard disk 3.5
- Compliant to USB 2.0 specification
- Supports data transfer rates up to 480Mbps
- LED Indicators: Power (Red), Access (Blue)
- Supports hot-plugging, plug and play compliant
- Size: 19.6cm x 11.1cm x 3.5cm (LxWxH)
- Supports Windows 7, Vista, XP and Mac OS 10.x



297949 / DA-71050

External HDD enclosure 3.5, IDE to USB 2.0

DIGITUS® External HDD Enclosure 3.5 SATA to USB 2.0



Easy Installation, Screwless Design

The DIGITUS external HDD enclosure gives you the flexibility to use your ordinary HDD in a modern and compact case. Its easy to use design allows you to quickly install a 3.5 SATA HDD and enjoy all advantages of an external drive. Just open the case and plug in your HDD, no need to use screws. Furthermore the compact design makes it really handy to transport your favorite data and access it over a simple USB 2.0 cable in your PC.

- Screwless design, easy assembling a hard disk
- Modern image is shown by the shining polished surface
- Suitable for standard SATA hard disk 3.5
- Compliant to USB 2.0 specification
- Supports data transfer rates up to 480Mbps
- LED Indicators: Power (Red), Access (Blue)
- Supports hot-plugging, plug and play compliant
- Size: 19.6cm x 11.1cm x 3.5cm (LxWxH)
- Supports Windows 7, Vista, XP and Mac OS 10.x



297956 / DA-71051

External HDD Enclosure 3.5, SATA to USB 2.0

DIGITUS® External 2x HDD enclosure

The maximum storage solution with the increased capacity for your photos, music, videos, and games

Suitable for 2 standard SATA / SATA II HDDs 3.5 (up to 1TB each)

- Aluminum housing with integrated cooling fan
- Data transfer rates: USB 2.0 480Mbps, SATA II 3Gbps
- Big mode & port multiplier: switching & tact switch
- Power indicator, red
- HDD access LED indicator, blue
- LED indicating active & connected HDDs, green
- USB interface LED indicator, blue
- eSATA interface LED indicator, blue
- Incl. eSATA connection cable, USB A/B connection cable and power supply
- Dimensions (L x W x H): 125mm x 200mm x 89mm
- Weight: 1.015kg
- Supports Windows 2000/XP/Vista/7, Mac OS 10.X



233909 / DA-70525
External 2x HDD enclosure, SATA to eSATA / USB 2.0

DIGITUS® External HDD enclosure 3.5, IDE or SATA to eSATA / USB 2.0

The ideal HDD enclosure to store and transfer large amounts of data

Suitable for standard IDE / SATA / SATA II HDDs 3.5

- Conforms to ATA/ATAPI-6 specification Rev. 1.0
- Complies with USB 2.0 specifications and with SATA 1.0 standards
- High speed USB data transfer rate up to 480Mbps
- Automatic determination of data transfer rates (Automation 3.0) / 1.5Gbps transmission rate negotiation with SATA HDDs
- 1 x USB B mini connector, 5-pin & 1 x eSATA connector
- Complies with USB Storage Class specification version 1.0
- LED indicators: power on (blue), status (red)
- Supports Windows 2000/XP/Vista/7, Mac OS 10.X



222750 / DA-70585
Ext. Festplattengehäuse 3.5, IDE/SATA auf eSATA /USB2.0

DIGITUS® USB 2.0 Hub 4-Port

Your connection possibilities increased

USB 2.0 and USB 1.1 compatible

- 4 x USB A, female (USB 1.1 and 2.0 devices)
- Maximum data transfer rate 480Mbps (USB 2.0)
- Over current protection on all outputs
- Supports hot-plugging, plug and play compliant
- USB connection cable (1m) and power supply included in delivery
- Supports Windows 7, Vista, XP, Mac OS X



278726 / DA-70225
4-Port USB 2.0 Hub

DIGITUS® USB 2.0 hub, 7-port

Your connection possibilities increased

USB 2.0 and USB 1.1 compatible

- 7 x USB A, female (USB 1.1 and 2.0 devices)
- Maximum data transfer rate 480Mbps (USB 2.0)
- Over current protection on all outputs
- Supports hot-plugging, plug and play compliant
- USB connection cable (1m) and power supply included in delivery
- Supports Windows 7, Vista, XP, Mac OS X



278733 / DA-70226
USB 2.0 hub, 7-port

DIGITUS® USB 2.0 hub, 10-port

Your connection possibilities increased

USB 2.0 and USB 1.1 compatible

- 10 x USB A, female (USB 1.1 and 2.0 devices)
- Maximum data transfer rate 480Mbps (USB 2.0)
- Over current protection on all outputs
- Supports hot-plugging, plug and play compliant
- USB connection cable (1m) and power supply included in delivery
- Supports Windows 7, Vista, XP, Mac OS X



278740 / DA-70228
USB 2.0 hub, 10-port

DIGITUS® USB 2.0 Hub 4-Port

Extend your connectivity!

The DIGITUS USB 2.0 4-Port Hub makes it simple to connect up to 4 USB devices at the same time to a PC or Mac. Plug in your favorite USB devices and profit from the very fast connection. This product has a clear and elegant design with a piano-black finish on the top and bottom surface, as well as an aluminium edge.

- USB 2.0 compliant
- Four USB 2.0 ports
- USB Mini B jack
- Supports USB High Speed 480Mbps and Full Speed 12Mbps
- Supports Media Copy and Hot-Swap
- Supports hot-plugging, plug and play compliant
- Color: black, silver
- Dimensions: 5.4cm x 2.8cm x 1.2cm

306535 / DA-70220

DIGITUS USB 2.0 4-Port, black, silver

DIGITUS® Slim Spider USB Hub

The slim connectivity solution, ideal to use at home or on the road

4-port USB 2.0 hub with a port on each end of the cables

- 4 x USB A jack, 1 x USB A plug
- Including DC-Jack for optional power supply
- Compliant with USB 2.0 specifications
- Supports data transfer rates up to 480Mbps
- Plug and Play and hot-swappable
- Overvoltage protection on each output
- Ready to connect with built-in USB connection cable
- Connection cable length 100cm
- Supports Windows 7, Vista, XP and Mac OS 10.x

284062 / DA-70216

4-Port USB Hub „Slim Spider“

DIGITUS® USB 2.0 hub illuminated, 4-port

Brings connectivity and style to the desktop

Compliant with USB 2.0 specifications

- 4-port hub (OHCI/EHCI)
- All ports support USB high speed (480Mbps), full speed (12Mbps), and low speed (1.5Mbps) transmissions
- Supports plug and play and hot swapping
- Equipped with over-current detection and over-current protection
- LED status indicators
- LED color: blue
- USB connection cable included in delivery
- Supports Windows 7, Vista, XP and Mac OS 10.x

183068 / DA-70210

USB 2.0 hub illuminated, 4-port

183075 / DA-70211

USB 2.0 Hub 4-Port illuminated w/ psu

DIGITUS® Card Reader All-in-one, USB 2.0



Transfer your digital content in a very quick and easy way!

The DIGITUS USB 2.0 All-in-One Card Reader makes it simple to transfer your digital content to a PC or Mac. The product gives you the ability to use nearly every type of memory card. It has a clear and elegant design with a piano-black finish on the top and bottom surface as well as an aluminium edge.

- USB 2.0 compliant
- Supports the following memory card types: CF, SD/SDHC/MMC/MMC4.0/RS-MMC/MMC PLUS/MMC Mobile/MMC Micro/miniSD, MS/MS Pro/MS Pro Duo, XD, Micro SD (T-Flash), M2
- USB Mini B jack
- Supports USB High Speed 480Mbps and Full Speed 12Mbps
- Supports Media Copy and Hot-Swap
- Supports hot-plugging, plug and play compliant
- Color: black, silver
- Dimensions: 5.4cm x 2.8cm x 1.2cm



306528 / DA-70322
Card Reader, USB 2.0, All-in-one

DIGITUS® „Tiny“ Card Reader USB 2.0



Convenient and space-saving!

The DIGITUS „Tiny“ USB 2.0 Card Reader enables you to transfer your digital data to your PC quickly and easily. Thanks to the slim and compact design as well as the integrated LED indicators, the product ensures convenient performance and easy transportation. Additionally, the case has a small clip on the backside for the short USB cable.

- USB 2.0 compliant
- Supports USB High Speed 480Mbps and Full Speed 12Mbps
- Supports the following memory card types: MS/MS Pro/ MSMG Duo/ M2, SD/MMC/Mini SD/SDHC/RSMMC/T-Flash
- Supports Media Copy and Hot-Swap
- Supports hot-plugging, plug and play compliant
- LED indicators
- Bus powered – no external power supply necessary
- Built-in USB cable
- Dimensions: 3.9cm x 3.6cm x 1cm



306511 / DA-70321
„Tiny“ USB Card Reader, USB 2.0, black

DIGITUS® USB 2.0 High-Speed Hub 4-Port



Extend your connectivity!

The DIGITUS „Tiny“ USB 2.0 4-port hub makes it simple to connect up to four USB devices simultaneously to a PC or Mac. Plug in your favorite USB devices and profit from the very fast connection. This hub has a fresh and compact design. The tiny case makes sure that you can transport this device very easily.

- USB 2.0 compliant
- Four USB 2.0 ports
- Supports USB High Speed 480Mbps and Full Speed 12Mbps
- Supports Media Copy and Hot-Swap
- Supports hot-plugging, plug and play compliant
- Color: black
- Dimensions: 4cm x 3.9cm x 1.1cm



306542 / DA-70217
„Tiny“ USB 4-port hub, USB 2.0, black

DIGITUS® USB2.0 multi card reader



Ready for the road - the compact always with you Card Reader

Supports MS, MS Pro, MS Duo, MS Pro Duo, HS MS, SDHC, SD, mini SD, Micro SD (Trans-Flash), MMC, RS-MMC memory cards

- Compliant with USB 2.0
- Complies with USB Storage Class specification version 1.0
- Supports Windows 7, Vista, XP and Mac OS 10.x



298472 / DA-70310-2
Multi Card Reader USB2.0

DIGITUS® Micro SDHC Ultra compact USB Card Reader

Ultra compact size, ideal for taking on-the-go

Supports Micro SD and Micro SDHC Flash Memory Cards

- Plug and play compliant
- Ideal for hi-fi systems and car radios with USB Memory player feature
- High speed USB data transfer rate up to 480Mbps
- Weight 2,3g
- Dimensions: 21mm x 14mm x 6mm
- Supports Windows 7, Vista, XP, Mac OS X

293842 / DA-70314-1

Micro SDHC Ultra compact USB Card Reader

DIGITUS® Card Reader All-in-one, USB 2.0

The fastest and easiest way to transfer digital images to your computer

Compliant to USB 2.0 specification

- Supports USB High Speed 480Mbps and Full Speed 12Mbps
- Supports Media Copy and Hot-Swap
- Supports hot-plugging, plug and play compliant
- Supports the following memory card formats: Compact Flash (CF) series, Memory Stick (MS) + M2 series, Secure Digital (SD / SDHC) + mini SD + Micro SD (Trans-Flash)
- Bus powered - no external power supply necessary
- Supports Windows 7, Vista, XP, Mac OS X

278818 / DA-70318

Card Reader, USB 2.0, All-in-one

DIGITUS® „Splodge Drive“ - Micro SDHC / M2 USB Card Reader

All of your media world on a thumbnail!

Supports Micro SD HC and M2 Card

- Ideal for hi-fi systems and car radios with USB Memory player feature
- Simultaneous operation of two inserted cards
- Driverless operation
- Compatible with PC and Mac
- Data transfer rate up to 480Mbps USB 2.0
- Supports Windows 2000/XP/Vista/7, Mac OS 10.X

273691 / DA-70317

USB Card Reader Micro SDHC / M2

DIGITUS® Card reader USB 2.0 56in1+ 3-port hub

One for all - reads and writes all common card formats

Compliant with USB 2.0 specifications

- Automatic system configuration (plug and play)
- Integrated 3-port USB hub
- Supports USB high speed (480Mbps), full speed (12Mbps), and low speed (1.5Mbps) data transfer modes
- Power supply possible via USB bus-power, supports up to 500mA/port (with additional power adaptor)
- Ports: 3 x USB type A, female, 1 x Mini USB type, female
- Supports the following memory card formats: Compact Flash (CF) series, Memory Stick (MS) + M2 series, Secure Digital (SD / SDHC) + mini SD + Micro SD (Trans-Flash)
- USB connection cable and CD-ROM with drivers included in delivery
- Supports Windows 7, Vista, XP and Mac OS 10.x

221777 / DA-70312

Card reader USB 2.0 56in1 + 3-port hub

DIGITUS® Universal Notebook Power Adapter

Slim and lightweight replacement or secondary power adapter for home, office or travel

Compact 70 Watt universal notebook power adapter

- Compatible with the major notebook brands like Acer, Asus, IBM, Dell, HP, Fujitsu, NEC, Toshiba, Sony, etc.
- Inclusive 11 different tips to fit almost any notebook
- Easy and safe output voltage selection by inserted tip
- LED identification shows the selected voltage
- Input: 100-240V AC 50-60Hz
- Output: 15V/16V/18V/18.5V/19V/19.5V/20V/ DC max. 70W
- High efficient and energy saving design
- Protection against overload, short circuit and overheating
- Built-in universal USB charging socket, e.g. for MP3 players, mobile phones, etc.
- Cable length: 100cm (power outlet to adapter), 110cm (adapter to Notebook)



278917 / DA-10070

Universal Notebook Power Adapter, 70W

278931 / DA-10090

Universal Notebook Power Adapter, 90W

DIGITUS® Universal Notebook Power Adapter

Slim and lightweight replacement or secondary power adapter for home, office or travel

Compact 90 Watt universal notebook power adapter

- Compatible with the major notebook brands like Acer, Asus, IBM, Dell, HP, Fujitsu, NEC, Toshiba, Sony, etc.
- Inclusive 11 different tips to fit almost any notebook
- Easy and safe output voltage selection by inserted tip
- LED identification shows the selected voltage
- Input: 100-240V AC 50-60Hz
- Output: 15V/16V/18V/18.5V/19V/19.5V/20V DC max. 90W
- High efficient and energy saving design
- Protection against overload, short circuit and overheating
- Built-in universal USB charging socket, e.g. for MP3 players, mobile phones, etc.
- Cable length: 100cm (power outlet to adapter), 110cm (adapter to Notebook)



278931 / DA-10090

Universal Notebook Power Adapter, 90W

DIGITUS® Universal Travel Notebook Power Adapter

Slim and lightweight design for traveling use

Compact 90 Watt universal notebook car adapter

- Compatible with the major notebook brands like Acer, Asus, IBM, Dell, HP, Fujitsu, NEC, Toshiba, Sony, etc.
- Inclusive 11 different tips to fit almost any notebook
- Easy and safe output voltage selection by inserted tip
- Input: 12-30V DC (car power adapter)
- Output: 15V/16V/18V/18.5V/19V/19.5V/20V DC max. 90W
- High efficient and energy saving design
- Protection against overload, short circuit and overheating
- Built-in universal USB charging socket, e.g. for MP3 players, mobile phones, etc.
- Cable length: 100cm (power outlet to adapter), 110cm (adapter to Notebook)



283683 / DA-10091

Universal Travel Notebook Power Adapter, 90W

DIGITUS® PC ATX power supply tester

The fastest way to check your power supply's health

Wrongly dimensioned and defective PC power supplies may result in an unstable computer system or even damage your expensive hardware components. Troubleshooting such a defective system usually takes a lot of time and is complex. This compact device for testing purposes, which can be handled easily and in a fast manner, will show you the proper status of all supplied voltages of your PC power supply with one glance.

- ATX power supply tester with LCD display
- Reliably indicates the accurate status of all power supply voltages
- Fast and easy plug and play operation
- Connectors for testing purposes of 20- / 24-pin mainboard connectors; for 4-pin, 6-pin, and 8-pin extension connectors, floppy connectors, and SATA connectors
- Robust aluminum housing
- Essential for service personnel and computer enthusiasts



200178 / DA-70601
PC ATX power supply tester with LCD

DIGITUS® USB 2.0 IDE & SATA Cable

Turns any SATA or IDE hard drive into a convenient to use external USB drive - ideal for backup and service

USB 2.0 adapter cable for fast and easy HDD connections - no external enclosure needed. Use any 2.5 / 3.5 IDE hard drive or SATA hard disk as an additional external hard drive. Ideal for service, maintenance, hassle-free temporary HDD access, e.g. for data backups and restore purposes.

- Supports 2.5/3.5 IDE and SATA HDDs (and 1.8 HDDs only with suitable adapter, not included)
- Supports SATA, SATA II
- Compliance with USB 2.0 (High-Speed)
- Compliance with USB Mass Storage Class
- Supports 480Mbps High Speed (HS) and 12Mbps Full Speed USB operation
- Supports ATA/ATAPI Ultra DMA mode
- Supports ATA/ATAPI PACKET command feature set
- Supports ATA/ATAPI LBA48-bit addressing mode
- High-speed data transfer, low power consumption
- Red / green LEDs indicating operation
- Incl. power supply
- Supports Windows 7, Vista, XP and Mac OS 10.x



287902 / DA-70148-2
USB 2.0 IDE & SATA Cable

DIGITUS® USB 2.0 IDE & SATA cable

The versatile alternative to an external hard drive - Ideal for service and backup

- Supports 2.5/3.5/5.25 IDE and SATA HDD's and devices
- Supports SATA, SATA II
- Compliance with USB 2.0 (High-Speed)
- Compliance with USB Mass Storage Class
- High speed USB data transfer rate up to 480Mbps
- High-speed data transfer, low power consumption
- Supports Windows 7, Vista, XP and Mac OS 10.x
- Power supply is not included, please use power from desktop computer itself. (Please refer to User Manual)



288305 / DA-70202
USB 2.0 IDE & SATA Cable

DIGITUS® USB to serial adaptor, USB 1.1

Connects serial devices via USB-Port to a PC

The elegant way to connect serial devices like modems, PDA, etc. via USB. The high compatibility guarantees transfer rates from more than 1Mbps.

- Easy connection of serial devices through an USB port
- Supports RS232 serial interface
- Compliant with USB 1.1 standards
- Data transfer rates 1Mbps and more
- Support remote wake-up and power management
- Can be used for PDA, modems and much more serial devices
- Chipset: PROLIFIC PL-2303HX
- Incl. USB extension cable, ca. 80cm
- Supports Windows 7, Vista, XP, Mac OS X and Linux



271604 / DA-70155

USB to serial adaptor, USB 1.1

DIGITUS® USB to serial adaptor, USB 2.0

Connects serial devices via USB-Port to a PC

The elegant way to connect serial devices like modems, PDA, etc. via USB. The high compatibility guarantees transfer rates from more than 1Mbps.

- Easy connection of serial devices through an USB port
- Supports RS232 serial interface
- Compliant with USB 2.0 standards
- Data transfer rates 1Mbps and more
- Support remote wake-up and power management
- Can be used for PDA, modems and much more serial devices
- Chipset: FTDI / FT232RL
- Incl. USB extension cable, ca. 80cm
- Supports Windows 7, Vista, XP, Mac OS X and Linux



271611 / DA-70156

USB to serial adaptor, USB 2.0

DIGITUS® USB - PS/2 adaptor

Use your legacy input devices - this adapter connects a PS/2 mouse and keyboard in only one USB port

Compatible with USB specification revision 1.1

- Supports PCs and SUN computers
- 2 x MiniDIN 6-pin female for PS/2 mouse and keyboard
- Power supply for USB devices connected via interface
- USB connection supports plug and play
- USB connector cable with USB A male
- Supports Windows 7, Vista, XP and Mac OS 10.x



117933 / DA-70118

USB -> PS/2 Adapter

DIGITUS® USB data link cable

Move pictures, music, movies and documents within seconds! Ideal for „on the fly“ file exchange with colleagues and friends.

Ready to connect! The USB Datalink Cable offers fast and simple direct data transfer between two PCs without complicated network configuration. No more need to mess about with USB Stick, disks and CDs to transfer files between computers. Move pictures, music, movies and documents within seconds! Ideal for „on the fly“ file exchange with colleagues and friends.

- Plug and Play Datalink Cable for easy PC to PC file transfers
- USB host to host communication
- Easy to use software with valuable applications included
- Remote Sharing Function: Emulates a network connection and enables Internet connection sharing
- Cable length 1,50m
- LED indicator
- USB 1.1 & USB 2.0 compatible
- Supports Windows 7, Vista and XP



278825 / DA-70010-1

USB data link cable for PC

DIGITUS® USB data link cable

Ultrafast PC and Mac data exchange without a network!

Ready to connect! The USB Datalink Cable offers fast and simple direct data transfer between two PCs and/or Macs without complicated network configuration. No more need to mess about with USB sticks, disks and CDs to transfer files between computers. Move pictures, music, movies and documents within seconds! Ideal for „on the fly“ file exchange with colleagues and friends.

- Plug and Play Datalink Cable for easy file transfer between PC and/or Mac computers
- Easy datatransfer between Windows and Mac OS (EasyMacCopy)
- USB host to host communication
- Driverless operation
- Easy to use software with valuable applications included
- Transfers personal files and settings from one PC to another with „EasyMover“
- PC to PC file and full Microsoft Outlook Synchronization as well as folder synchronization
- CD ROM remote access: can read CD ROM of other PC
- Cable length 1,50m
- LED indicator
- USB 1.1 & USB 2.0 compatible
- Supports: Windows 7, Vista, XP and Mac OS X



279228 / DA-70011-1

USB data link cable for PC and Mac

DIGITUS® USB 2.0 repeater cable

Expands the max. USB cable length permitted by additional 5m.

Extends maximum USB cable length permitted by 5.0m

- A maximum of 3 repeater cables can be combined for a total cable length of 20m
- Compatible with USB specification revision 2.0 and 1.1
- USB A male -> USB A female, cable length 5.0m
- Supports USB low speed (1.5Mbps), full speed (12Mbps) and high speed (480Mbps)
- USB connection supports plug and play
- Plastic housing, aluminum design
- Also usable with USB 2.0 devices featuring their own power supplies
- Operating systems supported: Windows 98SE or later Windows versions



233923 / DA-70130-3

USB 2.0 repeater cable 5m

293248 / DA-73100

USB 2.0 Repeater Cable 10m

DIGITUS® USB 2.0 Repeater Cable

The solution to use USB peripherals far away from your computer!

Expands the max. USB cable length permitted by additional 15m.

- Supports USB low speed (1.5Mbps), full speed (12Mbps) and high speed (480Mbps)
- Compatible with USB specification revision 2.0 and 1.1
- USB A male -> USB A female, cable length 15.0m
- USB connection supports plug and play
- Also usable with USB 2.0 devices featuring their own power supplies
- Supports Windows 7, Vista, XP, Mac OS X



306450 / DA-73101

USB 2.0 Repeater Cable 15m

306467 / DA-73102

USB 2.0 Repeater Cable 20m

306474 / DA-73103

USB 2.0 Repeater Cable 25m

DIGITUS® USB 2.0 sharing switch

No more plugging and unplugging between your computers and USB devices - The USB Sharing Switch allows to share a single USB device (like printers, scanners) between four computers

Compatible to USB 1.1 and USB 2.0 interface

- Compliant with USB 2.0 specifications
- Keyboard hot-key switching between the devices / PCs
- No additional power supply required - power supply via USB
- Operating systems supported: Windows 7/ XP / Vista / MacOS 9 (MacOS 9.2.2 recommended) / MacOS X (MacOS 10.2.8 or MacOS 10.3 recommended)



293224 / DA-70135-1

USB 2.0 Sharing Switch, 2 PC - 1 Device

293231 / DA-70136-1

USB 2.0 Sharing Switch, 4 PC - 1 Device

DIGITUS® USB extender

Conquer USB length limitations cost effectively and place your USB devices where ever you want them

USB 1.1 compatible

- Supports all standard USB devices, such as scanners, printers, cameras, etc.
- Maximum cable length between sending and receiving units 60m
- Connection with standard Cat5e UTP patch cable
- Only 1 sending unit and 1 receiving unit included in delivery
- Suitable for all operating systems, which support USB



233626 / DA-70139-1

USB extender

DIGITUS® USB 2.0 hub, FDD drive bay installation

Designed to provide quick and easy access for your USB peripherals

USB 2.0 and USB 1.1 compatible

- 4 x USB A, female (USB 1.1 and 2.0 devices)
- Installation size 9,9x2,6cm (3.5")
- Maximum data transfer rate 480Mbps (USB 2.0)
- Over current protection integrated on all outputs
- Hot pluggable, Plug and Play compatible
- Power supply via PC power supply
- Additional USB cable included in delivery
- Supports Windows 7, Vista, XP and Mac OS 10.x
- 2 x Frontpanel stickers - Black and Silver



233930 / DA-70133-2
USB 2.0 hub, 4-port

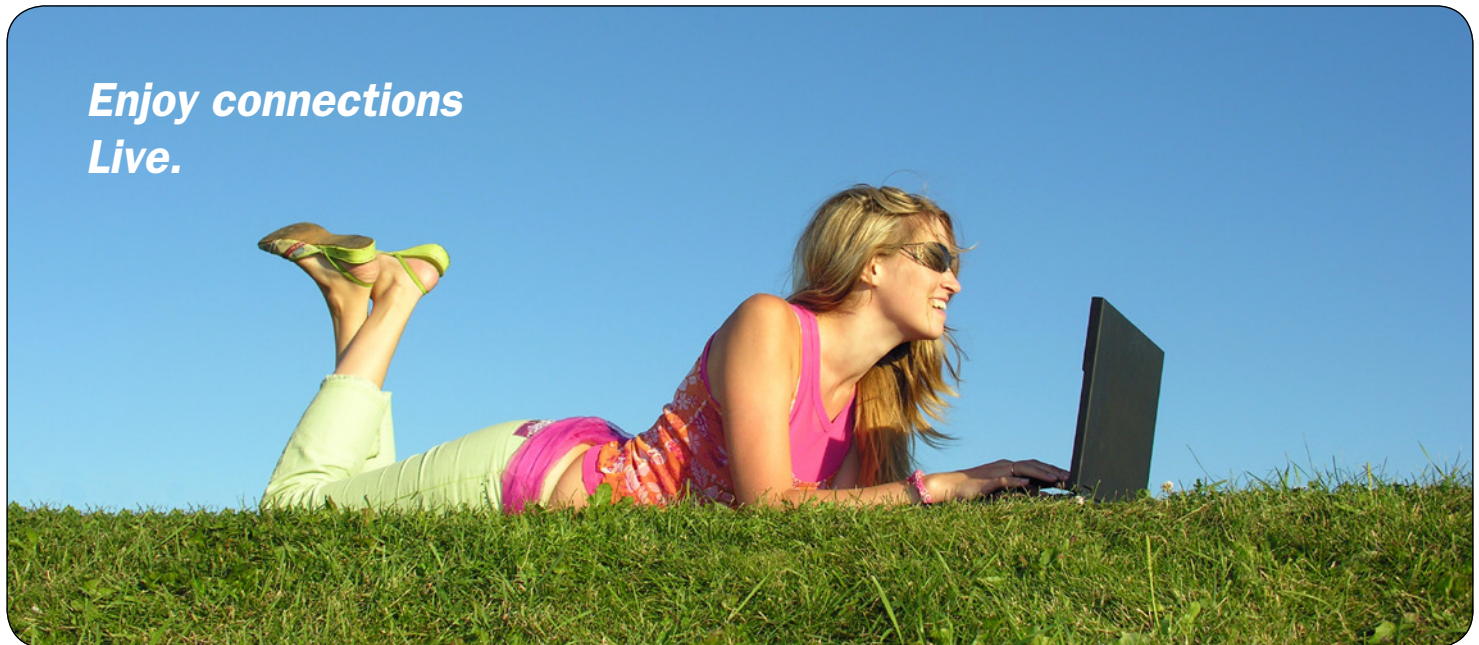

DIGITUS® hard drive installation kit including 2.5 => 3.5 adapter

For mounting HDDs 2.5 in desktop or tower computer cases

To install hard drives 2.5 in drive slots 3.5

- Two metal installation brackets and screws included in delivery
- Adaptor for 40-pin IDE cable and power supply adaptor included in delivery
- Hard drive installation kit 2.5=>3.5

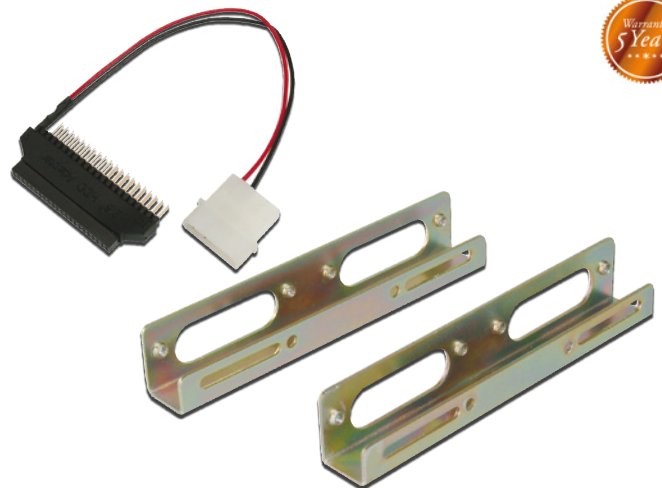

170372 / DA-70430
Hard drive installation kit 2.5 => 3.5



DIGITUS® Serial ATA HDD removable frame

Makes any hard drive 3.5 portable and allows it to be swapped quickly - Ideal for backups

Removable frame for hard drives, suitable for installations in CD/DVD - PC drive bays

- Suitable for Serial ATA hard drives 3.5
- Material: plastic
- 1 additional fan integrated
- Drawer lockable
- With status LED



194163 / DA-50214-A

Serial ATA HDD removable frame, gray

236399 / DA-50215

Serial ATA HDD removable frame, black

DIGITUS® IDE HDD removable frame

Makes any hard drive 3.5 portable and allows it to be swapped quickly - Ideal for backups

High quality hard drive frame, removable, for IDE hard drives 3.5

- Material of frame: plastic
- Frames are equipped with a fan (one additional fan for the drawer can be added)
- Drawer lockable
- With status LED



194149 / DA-50211-A

IDE HDD removable frame, grey

236429 / DA-50218

IDE HDD removable frame, black

DIGITUS® Premium SATA-Festplattenwechselrahmen, grau und schwarz

Damit wird aus jeder Festplatte 3.5 eine einfach auszutauschende, mobile Festplatte - ideal für Backups

Hochwertiger Festplattenwechselrahmen, für S-ATA Festplatten 3.5

- Voll-ALU-Gehäuse mit Kunststoffblende, besserer EMI / RFI Schutz
- Integrierter Lüfter an der Unterseite
- Schublade abschließbar
- Mit Status-LED



236412 / DA-50217

Premium SATA Festplattenwechselrahmen Aluminium, schwarz

DIGITUS® Reusable cable ties, pack of 5 pcs.

For a well-regulated cable management

Velcro fastener

- Five different colors
- Total length 16cm
- Width 16mm



170334 / DA-CT4001

cable ties, 5 pcs.

DIGITUS® USB printer cable

Installation within seconds - perfect to be used with notebooks and desktops without a parallel interface

Compatible with USB specification revision 1.1

- USB A male to CENT 36-pin male connector
- Supports EPP / ECP and bidirectional printing
- Data transfer rate up to 1,216 Mbps (ECP mode)
- Cable length: 1,8m



166306 / DC USB-PM1

USB printer cable, grey

DIGITUS® Dual 2.5 HDD Internal Mounting Kit

Maximize the internal space of your computer case

Supports installation of up to two 2.5 HDDs or SSDs in one 3.5 bay

- Work with HDDs and SSDs
- Also suitable for small Media Center PCs
- Easy installation
- Size: 11,5cm X 10,1cm X 2,3 cm
- Metal Material helps to release the heat of HDDs
- Including bracket and screws



291893 / DA-70431

Mounting KIT: Dual HDD 2.5 -> one 3.5 BAY

DIGITUS® 10 LEDs USB Lamp for notebook



Ultra Bright LED lights: perfect for working in low light environments

Energy saving and long-life span features come with LED Technology

- Ten white LEDs
- Clearly illuminates the keyboard or documents in low light environments
- Power supply for USB devices connected via interface
- Suitable to any USB compatible computer (PC or Mac)
- Flexible gooseneck
- Length: 45cm
- Power Consumption: 5V
- Slim and light: Ideal for traveling
- Suitable for working on the airplane, at night, and low light environments



296782 / DA-70759
USB 10 LEDs Lamp for notebook, Silver

DIGITUS® USB LED lamp

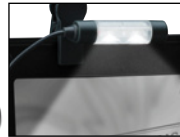

Illuminates your keyboard or nearby area - ideal for working in dim environments

Integrated white LED (efficient and energy saving)

- Powered by the USB port of A PC or Notebook
- Universal clip
- Clearly illuminates the keyboard or documents in low light environments
- Turns on when PC is powered up
- Cable length: 0.8m



183501 / DA-70756
USB LED light

DIGITUS® Notebook Lock with Number combination



Safety of your computer

Convenient connecting with any laptops and desktops with the built-in security slot

- Using the number combination which you prefer, no extra keys
- Simple set-up of number combination
- Material: Zinc-steel (locker part)
- Sturdy locking device featuring a 1,5m steel cable
- Suitable for office use, also for public occasions such as attending exhibitions, internet cafe etc..



288374 / DA-40500
Computer lock with number combination

DIGITUS® Notebook Lock with 2 Keys



Safety of your computer

Convenient connecting with any laptops and desktops with the built-in security slot

- Comes with 2 identical keys
- Suitable for office use, also for public occasions such as attending exhibitions, internet cafe etc..
- Material: Zinc-steel (locker part)
- Sturdy locking device featuring a 1,5m steel cable



288367 / DA-40501
Standard Slot Notebook Locks Incl. 2 Keys

DIGITUS® USB telephone handset



Comfortable internet telephony without headset or microphone

USB interface, plug and play

- Easy to use
- Power supply via USB, no external power supply required
- Separate sound card not needed to use this device
- Can be used as a microphone/speaker with all PC based softphones, such as Skype, MSN, ICQ, X-lite, Dialpad, MediaRing, Net2phone, etc.



185222 / DA-70772
USB telephone handset

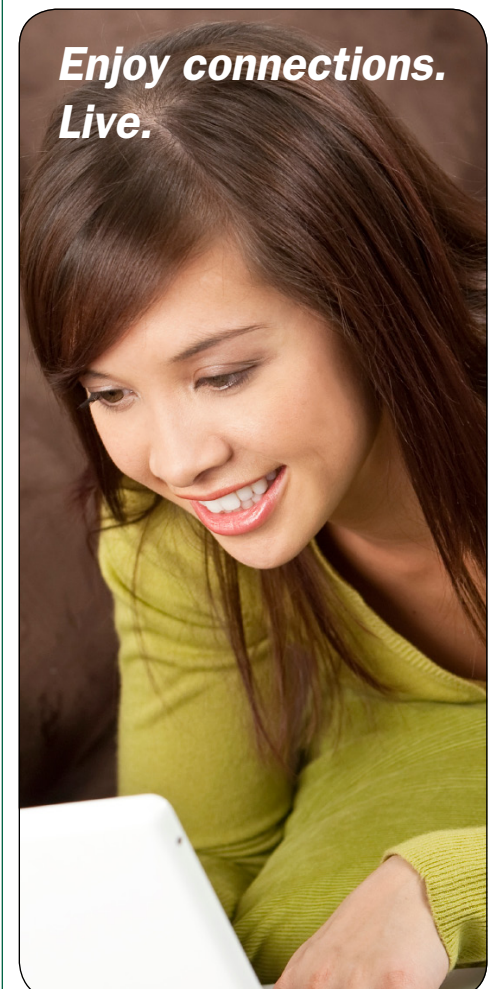

DIGITUS® Leather case for iPhone 4 & iPod Touch series

Best protection and trendy style for your iPhone 4 and iPod Touch series

The DIGITUS Leather case gives your iPhone 4 and iPod Touch series an individual style and protects your favorite Apple® device against scratching. This handmade leather case is the best way to carry your Apple® products, because it fits perfectly. A specially designed strap in the case makes sure that you can release the device quickly and easily. Moreover, it completely disappears within the case. Six individually stamped holes in the bottom give you the possibility to enjoy music playback or to simply twig the ringing while keeping the Apple® device safe in the case. In addition, you have a small pocket on the backside which can be used to transport your credit card, business card or cash.

- Leather case for iPhone 4 and iPod Touch series, black colored
- Special strap for easy pull-out
- Six stamped holes for the speakers
- Comfortable additional pocket on the backside
- Material: genuine leather
- Dimensions: 12.5cm x 7.9cm x 0.3cm
- Thickness incl. iPhone 4: 1.3cm



without iPhone

305576 / DA-14005

Leather case, black, for iPhone 4 and iPod Touch series

305583 / DA-14006

Leather case, brown, for iPhone 4 and iPod Touch series

305590 / DA-14007

Leather case, red, for iPhone 4 and iPod Touch series

DIGITUS® Slim leather case for iPad and iPad 2



Protects your iPad from scratching, impacting and surface damaging

Fashionable design, showing the professionalism and elegance

- Protects your iPad from scratching, impacting and surface damaging
- Anti-dust
- Fastener with Velcro closure, easy to release iPad from the case
- Material: PVC leather
- Inner material: Polyester
- Outer Size: 26,6cm(H) x 22,60cm(W) x 0,5cm(L) / Inner Size: 26,6cm(H) x 22,60cm(W) x 0,5cm(L)



295969 / DA-14001

Slim case for iPads

DIGITUS® Sleeve for tablet devices



Best protection and trendy style for your tablet device

The DIGITUS sleeve gives your Tablet PC protection against dirt and scratches, in a smart and elegant way. The water-resistant neoprene keeps your Tablet PC safe perfectly, no matter how you transport it. Furthermore, the classic outer skin gives the DIGITUS sleeve an elegant appearance. Through the above opening, you can insert and release your Tablet PC very easily. The Digitus sleeve is colored in elegant black with a discreet green DIGITUS logo.

- Protects your Tablet device with style
- Suitable for Tablet PC size up to 9.7" (24.64cm)
- Stretchable neoprene skin
- Water resistant
- Easy to open
- Size 25.3cm x 19.8cm x 0.8cm
- Color: black



305569 / DA-14002

Tablet PC sleeve, black, (9.7")

DIGITUS® Notebook bag

Perfect protection and multifunctional use for your notebook and accessories

Gives your notebook protection against dirt and scratches, in a smart and elegant way. The water-resistant polyester protects your notebook perfectly, no matter how you transport it. Furthermore, the structured outer skin gives the DIGITUS notebook bag an outstanding appearance. The additional inner pockets give you the ability to transport your notebook and accessories comfortably and safely. In addition, the Digitus notebook bag has two pockets on the outside for other accessories. The Digitus notebook bag has a classic design and is colored in black on the outside and green on the inside.

- Protect your notebook with style
- Three inner pockets and two outer pockets
- Padded, adjustable shoulder strap
- Two comfortable handles
- Structured outer skin in black



305514 / DA-14308

Notebook bag, black/green, (14.1")

305521 / DA-14309

Notebook bag, black/green, (15.6")

DIGITUS® Notebook sleeve

Best protection and good look for your notebook

The DIGITUS sleeve gives your notebook protection against dirt and scratches, in a smart and elegant way. The water-resistant neoprene keeps your notebook safe perfectly, no matter how you transport it. Furthermore, the structured outer skin gives the DIGITUS sleeve an outstanding appearance. Through the inner lip behind the zipper, you can transport your notebook very safely and take it out easily from sideways. The Digitus Sleeve is colored in elegant black with a grey colored zipper and two pull tabs.

- Protect your notebook with style
- Structured outer skin in black
- Color: black
- Material: structured neoprene
- All-round two-way zipper



305538 / DA-10506

Notebook sleeve, black, (12")

305545 / DA-10507

Notebook sleeve, black, (14.1")

305552 / DA-10508

Notebook sleeve, black, (15.6")

DIGITUS® Netbook Travel Set
Free Optical USB Travel Mouse included

Designed to fit netbooks with up to 26cm (10.1")

- Also ideal for transportation and protection of tablet computers, including the necessary accessories (such as Apple iPad, or other).
- High-quality finishing with durable fabric and protective soft padding
- Convenient extra compartments to store power supply, cables, peripherals and personal accessories
- Restraining strap ensures that the netbook is secure within the case
- Length adjustable shoulder strap, up to 120cm
- External dimension: 30 x 25 x 6 cm
- Inner dimension: 29 x 23,5 x 5 cm
- 100% high-durable Nylon fabric
- Optical USB travel mini mouse suitable for right and left hand using
- High precision optical sensor with 800dpi resolution
- Convenient retractable USB connection cable

285243 / DA-14301

Netbook Travel Set

DIGITUS® Netbook Travel Set
Free Optical USB Travel Mouse included

Designed to fit netbooks with up to 26cm (10.1")

- Also ideal for transportation and protection of tablet computers, including the necessary accessories (such as Apple iPad, or other).
- High-quality finishing with durable fabric and protective soft padding
- Convenient extra compartments to store power supply, cables, peripherals and personal accessories
- Restraining strap ensures that the netbook is secure within the case
- Length adjustable shoulder strap, up to 120cm
- External dimension: 30 x 25 x 6 cm
- Inner dimension: 29 x 23,5 x 5 cm
- 100% high-durable Nylon fabric
- Optical USB travel mini mouse suitable for right and left hand using
- High precision optical sensor with 800dpi resolution
- Convenient retractable USB connection cable

285564 / DA-14301-1

Netbook Travel Set

DIGITUS® Notebook Case, Smart Business Line



Interior fully padded with variable inside dividers

- Two hook and loop bands for securing the notebook
- Including flat zipper pocket in front
- Padded grip and shoulder strap
- Color: black
- Material: High-quality tweed nylon
- Exterior dimensions: 34cm(W) x 28.5cm(H) x 9.5cm(D)



127628 / DA-10203

Notebook Case, Smart Business Line

DIGITUS® Bag for 40cm (15.6“) Notebooks



Compatible to 40cm (15.6“) Notebooks and Laptops

- Outer size: 44.5cm (W) x 33cm (H) x 16,5cm (D)
- Inner size: 43cm (W) x 32cm (H) x 15cm (D)
- Offer your Notebook the best protection
- Four compartments, easily to separate and keep personal belongs
- Separated document tray
- Inner pocket for mobile phone, Pen holder, small pockets for personal accessories
- High- Quality Nylon material
- Zipper with two dampers
- Padded compartment with strip to fix the laptop
- Front pocket with Velcro closure
- Hand holder and shoulder strip



279457 / DA-14303

Notebook Bag for 40cm (15.6“)

279433 / DA-14302

Notebook Bag for 40cm (15.6“)

DIGITUS® Bag for 40cm (15.6“) Notebooks



Compatible to 40cm (15.6“) Notebooks and Laptops

- Outer Size: 44.5cm (W) x 33cm (H)x 8cm (D)
- Inner size: 43cm (W) x 32cm (H)x 6cm (D)
- Offer your Notebook the best protection
- Three compartments, easily to organize personal belongs
- Separated document tray
- Inner pocket for mobile phone, Pen holder, small pockets for personal accessories
- High- Quality Nylon material
- Zipper with two dampers
- Padded compartment with strip to fix the laptop
- Front pocket with Velcro closure
- Hand holder and shoulder strip



279433 / DA-14302

Notebook Bag for 40cm (15.6“)

DIGITUS® Notebook Bag, for 17 inches laptop



Compatible to 15“-17“ Notebooks and Laptops

- Outer Size: 46cm (W) X 33cm (H) X 6cm (D)
- Inner size: 44cm (W) X 32cm (H) X 5,5cm (D)
- Offer your Notebook the best protection
- High- Quality Nylon material
- Zipper with two dampers
- Padded compartment with strip to fix the laptop
- Inner pocket for mobile phone, Pen holder, small pockets for personal accessories
- Separated Inner document tray
- Front pocket with Velcro closure
- Hand holder and shoulder strip



283690 / DA-14307

Notebook Bag, for 17 inches Laptop

DIGITUS® CD-ROM/DVD Storage Cases for 48 CDs/DVDs



Lets you carry your CDs and DVDs with ease, also ideal for secure CD archiving

High-quality material in black colour

- Space for 48 CDs, DVDs, HD DVDs or Blue-rays
- Dimension (WxHxD): 17x17x7.5cm; 6.69x6.69x2x95"



136019 / DA-10210
CD-ROM/DVD Storage Cases, 48 CDs/DVDs

DIGITUS® CD-ROM/DVD Storage Cases for 48 CDs/DVDs



Lets you carry your CDs and DVDs with ease, also ideal for secure CD archiving

High-quality material in black colour

- Space for 48 CDs, DVDs, HD DVDs or Blue-rays
- Dimensions (WxHxD): 17x29x4cm; 6.30x11.42x1.58"



136026 / DA-10211
CD-ROM/DVD Storage Cases, 48 CDs/DVDs

DIGITUS® CD-ROM/DVD Storage Cases for 96 CDs/DVDs



Lets you carry your CDs and DVDs with ease, also ideal for secure CD archiving

High-quality material in black colour

- Space for 96 CDs, DVDs, HD DVDs or Blue-rays
- Dimensions (WxHxD): 18x29x8cm; 7.09x11.42x3.15"



136033 / DA-10212
CD-ROM/DVD Storage Cases, 96 CDs/DVDs

DIGITUS® CD-ROM/DVD Storage Cases for 200 CDs/DVDs



Lets you carry your CDs and DVDs with ease, also ideal for secure CD archiving

High-quality material in black colour

- Space for 200 CDs, DVDs, HD DVDs or Blue-rays
- Dimensions (WxHxD): 31x32x10cm; 12.21x12.60x3.94"



179801 / DA-10220
CD-ROM/DVD Storage Cases, 200 CDs/DVDs

DIGITUS® CD-ROM and DVD Cases



Protects your optical media - CD, DVD, Blu-ray, etc.

For two DVD's / CD's

- Suitable for CDs, DVDs, HD DVDs, Blue-rays
- Black plastic, slide-in foil
- Packaging unit: 5 Pcs.
- Dimensions (WxHxD): 190x130x5mm; 7.48x5.12x0.20"



132899 / DA-DVD-DC
CD-ROM / DVD Double Case, 5 pcs

DIGITUS® CD-ROM and DVD Cases



Protects your optical media - CD, DVD, Blu-ray, etc.

For one DVD/CD with additional manual

- Suitable for CDs, DVDs, HD DVDs, Blue-rays
- Black plastic, slide-in foil
- Packaging unit: 5 Pcs.
- Dimensions (WxHxD): 190x130x5mm; 7.48x5.12x0.20"



176206 / DA-DVD-SC
CD-ROM / DVD Single Case, 5 pcs

DIGITUS® CD-ROM and DVD Cases



Protects your optical media - CD, DVD, Blu-ray, etc.

DVD / CD Jewel Case

- Suitable for CDs, DVDs, HD DVDs, Blue-rays
- Transparent plastic
- Packaging unit: 10 Pcs.



132882 / DA-CD-JC
CD-ROM Jewel Case, 10 pcs.

DIGITUS® CD-ROM and DVD Cases



Protects your optical media - CD, DVD, Blu-ray, etc.

DVD / CD Slim Case

- Suitable for CDs, DVDs, HD DVDs, Blue-rays
- Transparent plastic
- Packaging unit: 10 Pcs.



132875 / DA-CD-SC
DIGITUS CD-ROM Slim Type Case, 10 pcs.

Wall mount for TFT displays

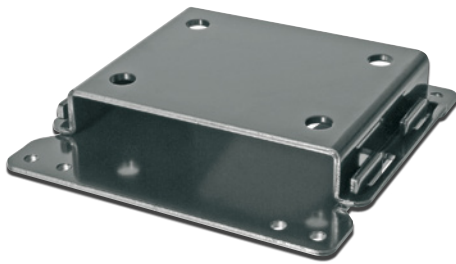

Brings viewing comfort to your living room

Small hook attachment for wall mounting

- Supports VESA standard dimensions (75x75mm and 100x100mm)
- Net weight: 0.5kg Dimensions 114x114x21.5mm
- Maximum loading: 30kg



239369 / DA-90303
Wall mount for TFT displays

Wall mount for TFT displays



TFT display swivel arm
for table mounting

- Easy to install by means of special table clamp
- Can be moved in any direction
- Supports VESA standard dimensions (75x75mm and 100x100mm)
- Net weight: 2.0kg
- Overall length: 520mm
- Maximum height: 315mm
- Max. load capacity: 10kg
- Maximum thickness of the tabletop: 75mm
- LCD monitor can be turned: 180 degrees
- Excellent way of saving space



259671 / DA-90306-1
For table mounting, black

Wall mount for TFT displays



Brings viewing comfort to your living room

Supports VESA standard dimensions (75x75mm and 100x100mm)

- Net weight: 0.8kg; overall length 80mm; max. load capacity 15kg
- Monitor can be turned: 180°



239376 / DA-90307
Wall mount for TFT displays



Enjoy connections
Live.

DIGITUS® Wall mount for LCD/TFT TV



Brings viewing comfort to your living room

Small wall mounting for up to 110cm (42") LCD/TFT TV's

- Supports VESA standard dimensions (100x200mm and 200x200mm)
- Net weight: 1.7kg Dimensions 230x230x25.3mm
- Maximum loading: 70kg
- Projection: 25mm



239383 / DA-90310

Wall mount for LCD/TFT TV up to 70kg

DIGITUS® Wall mount for LCD/TFT TV



Brings viewing comfort to your living room

Articulating wall mount for up to 82cm (32") LCD/TFT TV

- Easy installation and strong combination both
- Supports VESA standard dimensions (75x75mm, 200x100mm, 100x100mm and 200x200mm)
- Maximum loading: 32kg
- Swivel left & right: 20, 180 degrees
- Pivot upwards & downwards: 20 degrees



239406 / DA-90312

Wall mount for LCD/TFT TV up to 32kg

DIGITUS® LCD wall mount for LCD/TFT TV



Brings viewing comfort to your living room

Simple heavy loading wall mount for up to 110cm (42") LCD/TFT TV

- Easy to mountable and 360 degrees flexible
- Supports VESA standard dimensions (200x100mm and 100x100mm)
- Weight: 2kg, 185x450x85mm (WxD)
- Maximum loading: 50kg
- Swivel left & right: 20 degrees
- Pivot upwards & downwards: 20 degrees
- LCD monitor swivel: 360 degrees



239390 / DA-90311

Wall mount for LCD/TFT TV up to 50kg

DIGITUS® Wall mount for LCD/Plasma TV



Brings viewing comfort to your living room

Universal adjustable wall mount and tilting for up to 165cm (65") LCD/Plasma TV

- Easy installation and strong combination both
- Weight: 4.9kg, 760x800x520mm (WxDxH)
- Maximum loading: 80kg
- Pivot upwards and downwards: 26 degrees



239413 / DA-90313

LCD/Plasma wall mount for up to 165cm (65") TV

DIGITUS® 4x USB 3.0 PCI Express Add-on Card

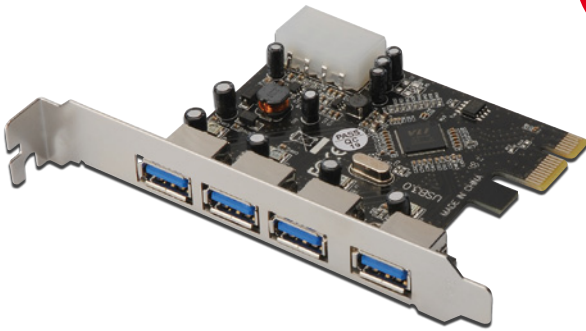

Data transfer rate up to 5Gbps

The performance boost for the new generation of ultra fast USB peripherals

- 4 x USB 3.0 Ports
- VL800 chipset
- Downward compatible to USB 2.0/1.1 devices
- Supported data transfer rates: Super-speed (5Gbps), High-speed (480Mbps), Full-speed (12Mbps) and Low-speed (1.5Mbps)
- Supports plug and play and hot swapping
- Compliant with Universal Serial Bus 3.0 specification Revision 1.0
- Compliant with PCI Express Base Specification 2.0; bus interface: PCI-Express x 1
- Supports PCI Bus Power Management Interface Specification revision 1.2
- Supports Windows 7, Vista and XP
- Microsoft certified WHQL drivers for Windows 7 32/64-bit, Vista 32/64-bit and XP 32/64-bit



309338 / DS-30221
USB 3.0 PCI Express Add-on Card, 4-Port

DIGITUS® 2x USB 3.0 PCI Express Add-on Card

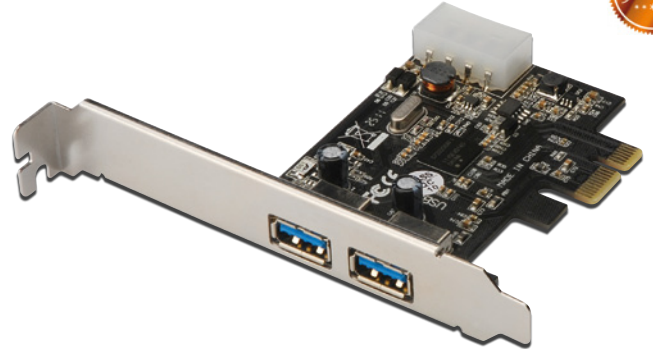

The performance boost for the new generation of ultra fast USB peripherals

Looking for a quick and easy way to add USB 3.0 into your computer? Well, look no further, DIGITUS takes care of that. The DIGITUS USB 3.0 PCI Express extension card features two USB 3.0 Type A downstream connectors that can deliver transfer rates up to 5Gbps!

- 2 x USB 3.0 Ports
- Chipset: NEC D720200
- Downward compatible to USB 2.0/1.1 devices
- Supported data transfer rates: Super-speed (5Gbps), High-speed (480Mbps), Full-speed (12Mbps) and Low-speed (1.5Mbps)
- Supports plug and play and hot swapping
- Compliant with Universal Serial Bus 3.0 specification Revision 1.0
- Compliant with PCI Express Base Specification 2.0; bus interface: PCI-Express x 1
- Supports PCI Bus Power Management Interface Specification revision 1.2
- Incl. Low Profile bracket
- Supports: Windows 7, Vista, XP



309321 / DS-30220-3
USB 3.0 PCI Express Add-on Card, 2-Port

DIGITUS® USB 2.0 4+1 Port PCI Express card

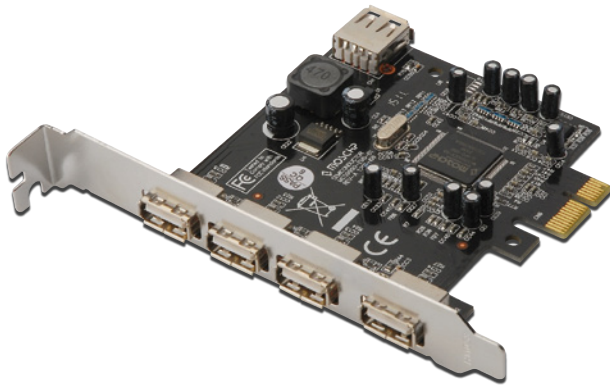

The quick and easy way to add extra USB Ports to your system

Easy plug and play makes installation a breeze, and hot swapping capabilities guarantee convenient, hassle-free connections without rebooting.

- 4 x external and 1 x internal USB 2.0 Ports
- Chipset: MCS9990
- Supports high-speed (480Mbps), full-speed (12Mbps), and low-speed(1.5Mbps) data transfer modes for simultaneous operation of multiple USB 2.0/1.1 devices
- Support device hotswapping and Plug and Play
- Installs in any available PCI Express slot with different lane width
- Supports Windows 7, Vista and XP



309352 / DS-30202-1
USB 2.0 4-port PCI Express card

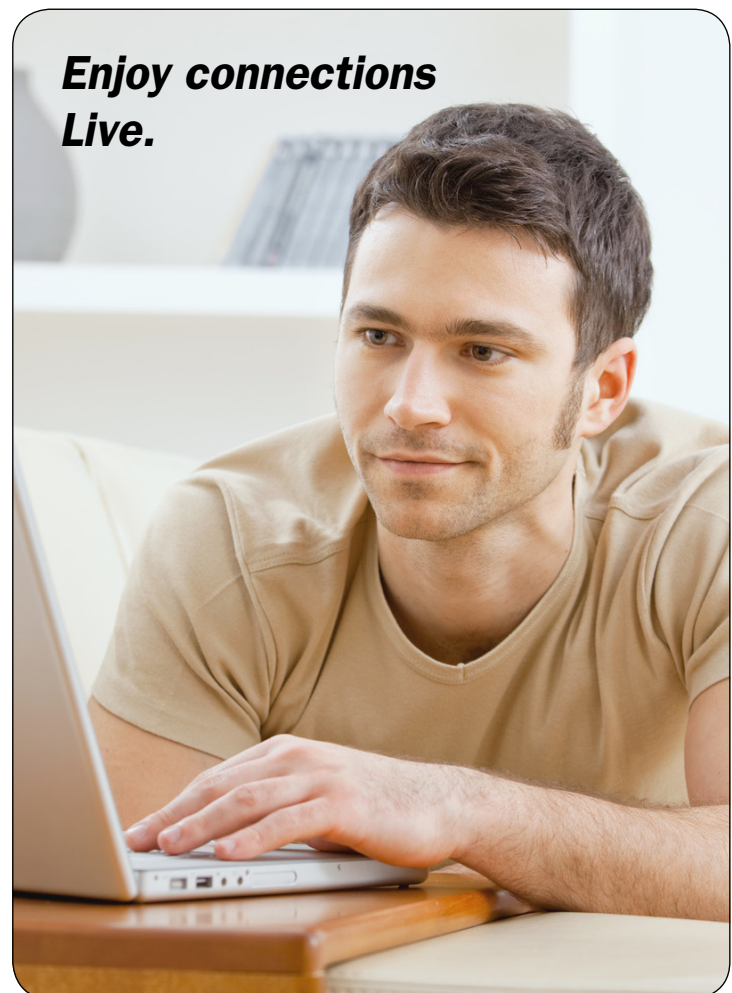

DIGITUS® IEEE 1394a Firewire PCI Express Card

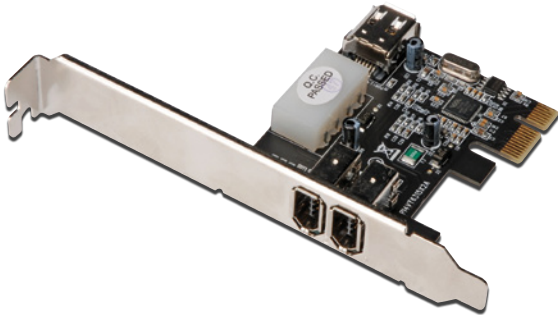

2 x external and 1 x internal IEEE 1394 ports, 6-pin

- Chipset: VIA 6315
- Data transferrate 100 / 200 / 400 Mbps
- Support device hotswapping and Plug and Play
- Compliant with IEEE 1394 and OHCI 1.1 standards and specifications
- Installs in any available PCI Express slot with different lane width
- Incl. software „Ulead Videostudio“
- Supports Windows Vista/XP/Server 2003 SP1/2000



269038 / DS-30201-2

IEEE 1394a Firewire PCI Express Card

DIGITUS® 1x Parallel interface card, PCIe

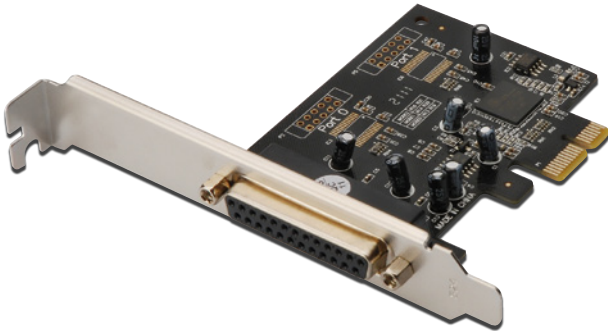

Take full advantage of all your high-speed parallel devices

Get more out of your parallel peripherals! DIGITUS parallel interface card, PCIe helps your old parallel devices perform like never before! With data transfer speeds of up to 2.5 Mbits/sec – up to 3 times faster than built-in parallel ports!

- 1 x DSUB 25, parallel port, jack
- Chipset: OXPcie952
- Data transfer rate up to 2.5Mbps
- Supports Standard Parallel Port (SPP), Enhanced Parallel Port (EPP) & Enhanced Capability Port (ECP)
- Compliant with PCI Express base specification 1.1
- Compliant with PCI Power Management 1.2
- Supports Windows 7, Vista and XP
- Incl. Low Profile bracket



309383 / DS-30020-1

PCIe, Parallel interface card 1x DSUB 25

DIGITUS® Firewire 800 / 400 Combo card, PCIe



The quick and easy way to add extra Firewire Ports to your system

2 x FireWire 800 (1394b) 9-pin ports and 1x FireWire 400 (1394a) 6-pin port

- Chipset: TI XIO2213B
- Data transfer rates of 100, 200, 400, and 800Mbps
- Built-in 4-pin power connector, provides extra power when connected to the system power supply (recommended)
- Supports hot-swapping and Plug and play connections of peripheral devices
- Works with various types of FireWire 800 (1394b) and FireWire 400 (1394a) devices, including external hard disk drives, DV camcorders, digital cameras, CD-RW/DVD-ROM drives, and other audio/video devices
- Support Windows® 7 / Vista / Server 2003 SP1 or above / XP / 2000
- Accessories: 1 x manual, 1 x Ulead Video Studio CD



276579 / DS-30203-1

PCIe, FireWire 800/400 interface card, 2/1-ports

DIGITUS® 2ser. / 1par. interface card, PCIe

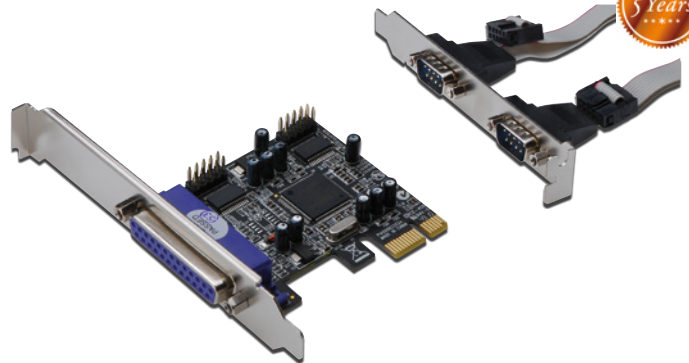

Perfect for connecting any parallel or serial device including printers, scanners and ISDN terminal adapters

Multi I/O PCIe card

- 2 x DSUB 9, serial ports, male, UART16C450/550
- 1 x DSUB 25, parallel port, jack
- Chipset: MCS9901
- Serial data transfer rate up to 230,400bps
- Parallel data transfer rate up to 1.5Mbps
- Supports Standard Parallel Port (SPP), Enhanced Parallel Port (EPP) & Enhanced Capability Port (ECP)
- Compliant with PCI Express Base Specification 1.0a
- 1 x manual, 1 x driver CD, 1 x DSUB 25 parallel port cable, 3 x low profile brackets included in delivery
- Supports Windows Vista/Server 2003/XP/2000



254386 / DS-30040

PCIe, 2 ser. / 1 par. interface card

DIGITUS® 2x Serial interface card, PCIe

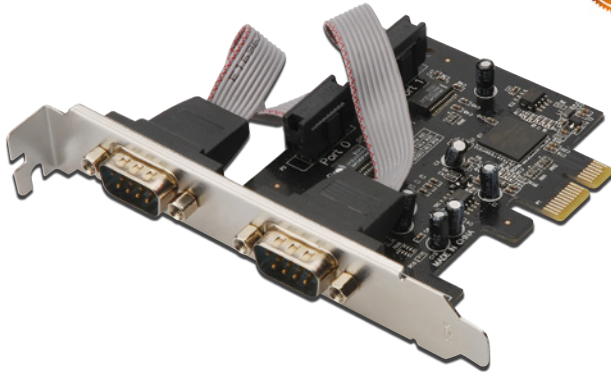

Perfect for connecting serial modems, PDAs, digital cameras, printers, ISDN terminal adapters and many more

This PCI Express based serial Add-On card allows you to turn a PCI Express slot into two RS232 (DB9) serial ports. Based on a native single chip design reduces the load applied to the CPU by as much as 48% over conventional serial cards.

- 2 x DSUB 9, serial ports, male, UART 16C950
- Chipset: OXPcie952
- Data transfer rate up to 230,400bps
- Compliant with PCI Express base specification 1.1
- Compliant with PCI Power Management 1.2
- Supports Windows 7, Vista and XP



309390 / DS-30000-1
PCIe, Serial interface card, 2x DSUB 9

DIGITUS® SATA II PCI Express card, 2-Port

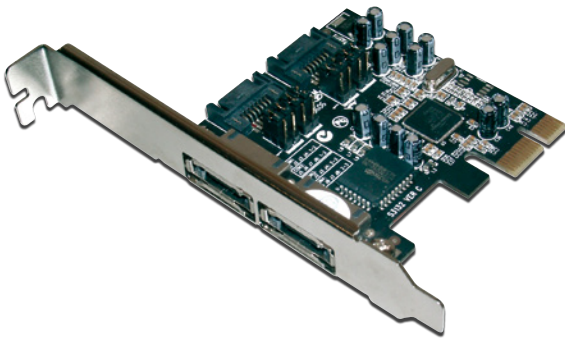

The quick and easy way to add Serial ATA performance to your PC

2 x external eSATA and 2 x internal SATA ports

- Chipset: Sil 3132
- Int. / ext. ports selectable by configuration
- Compliant with PCI Express Base Specification 1.0a
- Compliant with Serial ATA 1.0a specification and with full complement of Serial ATA II optional features
- Installable in any available PCI Express slot with different lane widths
- Supports RAID levels 0, 1, 0+1
- Supports data transfer rate of up to 300MB/s
- Supports NCQ (Native Command Queuing)
- Hot-Plug and Hot-Swapping features
- Supports Windows 7, Vista and XP



245056 / DS-30102
SATA II PCI Express card, 2-port

DIGITUS® SATA II PCI Express card, 1-port

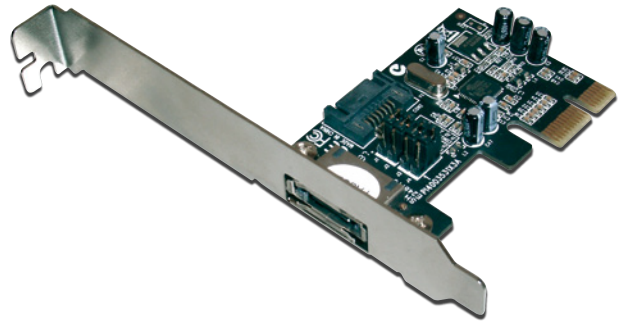

The quick and easy way to add Serial ATA performance to your PC

1 x external eSATA port and 1 x internal SATA port

- Chipset: Sil 3531
- Int. / ext. ports selectable by configuration
- Compliant with PCI Express Base Specification 1.0a
- Compliant with Serial ATA 1.0a specification and with full complement of Serial ATA II optional features
- Installable in any available PCI Express slot with different lane widths
- Supports data transfer rate of up to 300MB/s
- Supports NCQ (Native Command Queuing)
- Hot-Plug and Hot-Swapping features
- Supports Windows 7, Vista and XP



244813 / DS-30101
SATA II PCI Express card, 1-port

DIGITUS® SATA II / PATA PCI Express combo card

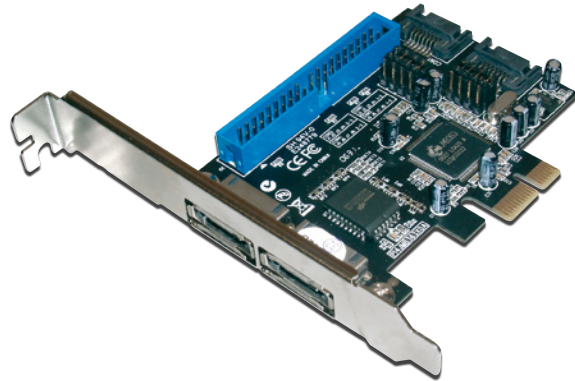

Offers the flexibility to connect almost any type of drive to your computer

2 x external eSATA and 2 x internal SATA ports

- Int. / ext. ports selectable by configuration
- 1 x internal parallel ATA port - supports up to UDMA-6 transfer mode
- Chipset: JMB 363
- Up to 4 devices connectable in total
- Compliant with PCI Express Base Specification 1.0a
- Compliant with Serial ATA 1.0a specification and with full complement of Serial ATA II optional features
- Supports data transfer rate of up to 300MB/s
- Supports RAID levels 0, 1, 0+1
- Installable in any available PCI Express slot with different lane widths
- Supports NCQ (Native Command Queuing)
- Hot-Plug and Hot-Swapping features on SATA ports
- Supports Windows 7, Vista and XP



244950 / DS-30103
SATA II / PATA PCI Express combo card

DIGITUS® SATA II PCI Express card, 4-port

The quick and easy way to add Serial ATA performance to your PC

4 x internal Serial ATA connectors, 2 x external eSATA connectors (selectable)

- Chipset: MARVELL 88SX7042
- Bus specification: PCI-Express x 4
- Compliant with Serial ATA II specifications, up to 300MB/sec
- Supports SATA II Native Command Queuing (NCQ)
- Stand-alone PCI Express to Serial ATA host controller
- Four independent Serial ATA channels, each of them supporting one connection of a Serial ATA device at the same time
- Supports Windows 7, Vista and XP

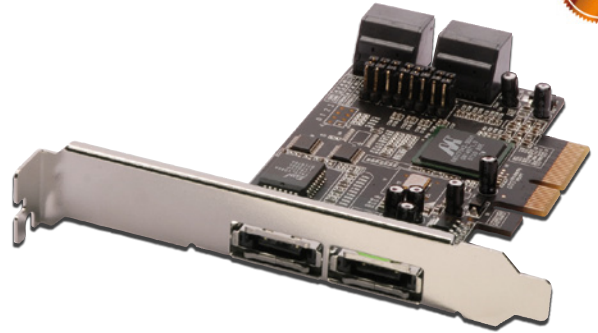

245049 / DS-30104
SATA II PCI Express card, 4-port

DIGITUS® SATA III / PATA PCI Express combo card

Combines the performance boost of the new SATA III with up to 6Gbps with the flexibility to connect almost any type of HDD to your computer

2 x internal SATA III ports

- 1 x internal parallel ATA port - supports up to UDMA-6 transfer mode, ATA and ATAPI
- Chipset: Marvell 88SE9128
- Up to 4 devices connectable in total
- Compliant with PCI-Express Specification v2.0 and backward compatible with PCI-Express 1.x
- Compliant with Serial ATA Specification 3.0
- Supports communication speeds of 6Gbps, 3Gbps and 1.5Gbps
- Supports RAID levels 0 and 1 (only for SATA hard drives)
- Installable in any available PCI Express slot with different lane widths
- Supports NCQ (Native Command Queuing)
- Supports Port Multiplier FIS
- Hot-Plug and Hot-Swapping features on SATA ports
- Incl. Low Profile bracket
- Supports Windows 7, Vista and XP

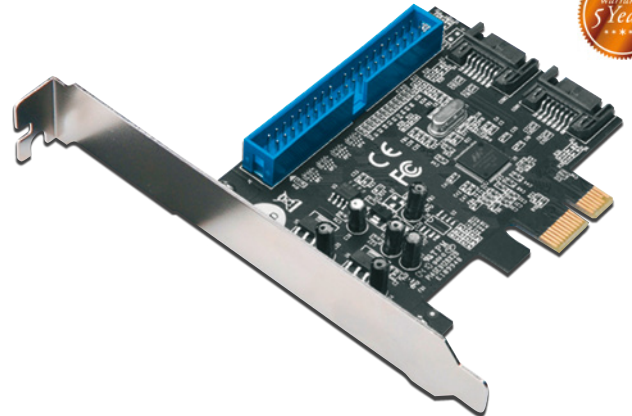

282006 / DS-30106
SATA III / PATA PCI Express combo card



**Enjoy connections
Live.**

DIGITUS® USB 3.0 ExpressCard

The performance boost for the new generation of ultra fast USB peripherals

2 x USB 3.0 Ports

- Chipset: NEC D720200
- Downward compatible to USB 2.0/1.1 devices
- Supported data transfer rates: Super-speed (5Gbps), High-speed (480Mbps), Full-speed (12Mbps) and Low-speed (1.5Mbps)
- Supports plug and play and hot swapping
- Supports Plug and Play and Hot-swap; compliant to ExpressCard Specification 1.0; ExpressCard/34 form factor module
- DC Jack connector for optional power adaptor (+5V/18mA) to meet the USB 3.0 power standard
- Supports: Windows 7, Vista, XP



273707 / DS-31220

USB 3.0 ExpressCard, 2-Port

DIGITUS® USB 2.0 ExpressCard

The quick and easy way to add extra USB Ports to your Notebook

4 x USB 2.0 Typ A Ports

- Chipset: NEC 720114
- ExpressCard/34 form factor
- Data transfer rate up to 480 Mbps
- Support device hotswapping and Plug and Play
- Compliant with EHCI and OHCI standards and specification
- 1 x DC power jack (5V /2A)
- Supports Windows 7, Vista and XP



244943 / DS-31203

DIGITUS USB 2.0 ExpressCard 4 ports

DIGITUS® Combo USB 2.0 / Firewire ExpressCard

1 x USB 2.0 Typ A jack

- 2 x IEEE1394 6-pin Ports
- Chipset: VIA 6315
- ExpressCard/34 form factor
- Data transfer rate: IEEE 1394 100 / 200 / 400 Mbps, USB 2.0 up to 480Mbps
- Support device hotswapping and Plug and Play
- Compliant with IEEE 1394, OHCI 1.1 and ExpressCard 1.0 standards and specification
- 1 x DC power jack (12V /1A)
- Incl. software „Ulead Videostudio“
- Supports Windows 7 / Vista / XP / Server 2003 / 2000



269304 / DS-31202-1

Combo USB 2.0 / Firewire ExpressCard

DIGITUS® IEEE 1394a / Firewire ExpressCard

The quick and easy way to add extra Firewire Ports to your Notebook

2 x IEEE1394 6-pin Ports

- Chipset: VIA 6315
- ExpressCard/34 form factor
- Data transferrate 100 / 200 / 400 Mbps
- Support device hotswapping and Plug and Play
- Compliant with IEEE 1394, OHCI 1.1 and ExpressCard 1.0 standards and specification
- 1 x DC power jack (12V /1A)
- Incl. „Ulead VideoStudio“ Software
- Supports Windows 7 / Vista / XP / Server 2003 / 2000



269298 / DS-31201-2

IEEE 1394a / Firewire ExpressCard

DIGITUS® eSATA II 300 ExpressCard

Mobile Convenience with your portable storages!

eSATA II 300 ExpressCard, slim version

- 1 eSATA port
- Easy install with Plug and Play
- ExpressCard/34 form factor
- SATA data transfer rate up to 3.0 Gbps
- Supports hot plug for connected devices
- Compliant with ExpressCard 1.0 specification
- Supports SATA II Native Command Queuing (NCQ)
- Supports Windows 7, Vista, XP



296881 / DS-31101-1

eSATA II 300 ExpressCard, slim version



*Enjoy connections
Live.*

DIGITUS® RS 232 ExpressCard

Perfect for connecting serial modems, PDAs, digital cameras, printers, ISDN terminal adapters and more

1 x DSUB 9 / RS-232, serial port, male

- Chipset: PL 2303X
- ExpressCard, form factor 34
- Data transfer rate up to 230,400bps
- Supports hot-swapping of devices and plug and play
- Powered via express bus, no separate power supply or battery required
- Works with various types of RS-232 serial devices, including modems, PDAs, label printers, bar code scanners, digital cameras, and more
- Supports Windows 7, Vista and XP



244875 / DS-31204

RS 232 ExpressCard 1 port

244882 / DS-31205

RS 232 ExpressCard 2 ports

DIGITUS® Parallel port ExpressCard

Take full advantage of all your high-speed Parallel devices

1 x DSUB 25, parallel port, jack

- Chipset: PL2305
- ExpressCard, form factor 34
- Supports hot-swapping of devices and plug and play
- Powered via express bus, no separate power supply or battery required
- Works with various types of printers with parallel interfaces
- Supports Windows 7, Vista and XP



244868 / DS-31206

Parallel port ExpressCard

DIGITUS® Seriell, parallel combo ExpressCard

Perfect for connecting any parallel or serial device including printers, scanners and ISDN terminal adapters

1 x DSUB 9 / RS-232, serial port, male

- 1 x DSUB 25, parallel port
- Chipset: MCS 7715
- ExpressCard, form factor 34
- Supports hot-swapping of devices and plug and play
- Powered via express bus, no separate power supply or battery required
- Works with various types of parallel and RS-232 serial devices, including modems, PDAs, printers, bar code scanners, digital cameras, and more
- Incl. adapter cable (DB26 Female to 1 x DB9 Male + 1 x DB25 Female)
- Supports Windows 7, Vista and XP



244851 / DS-31207

Seriell, parallel combo ExpressCard

DIGITUS® USB 2.0, PCI card

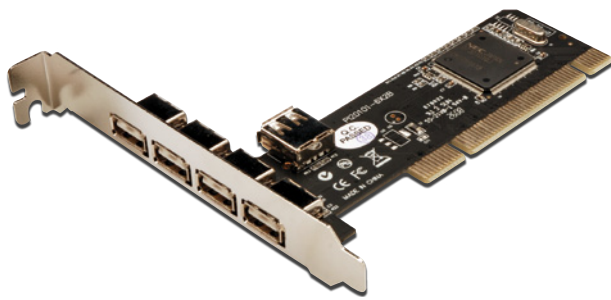

The quick and easy way to add extra USB Ports to your Computer

- 4 x external USB 2.0 type A/female (480Mbps)
- 1 x internal USB 2.0 type A/female (480Mbps)
- Chipset: NEC 720101
- Supports USB high speed (480Mbps), full speed (12Mbps), and low speed (1.5Mbps) data transfer modes
- Compliant with USB specification revision 2.0
- Supports hot-swapping
- Operating systems supported: Windows 2000 / XP / Vista 32-bit/64-bit
- Accessories: 1 x manual



254287 / DS-33220
PCI, USB 2.0 card, 4+1-ports

DIGITUS® USB 2.0 / FireWire Combo card, PCI

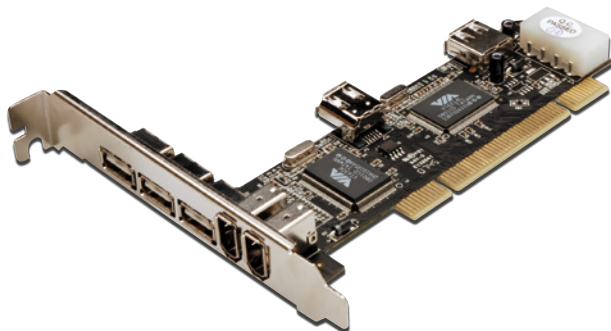

Features high-speed USB and Firewire access for quick and efficient data transmission

- Combo card USB 2.0 and FireWire 400 (1394a)
- 3 x external USB 2.0 type A/female (480Mbps)
- 1 x internal USB 2.0 type A/female (480Mbps)
- 2 x external FireWire 400 (1394a) 6-pin ports (400Mbps)
- 1 x internal FireWire 400 (1394a) 6-pin port (400Mbps)
- Chipsets: VIA6212/6214 + VT6306
- Compliant with USB specification revision 2.0
- Supports USB high speed (480Mbps), full speed (12Mbps), and low speed (1.5Mbps) data transfer modes
- Compliant with IEEE 1394-1995, 1394a-2000, and OHCI 1.1 standards
- Supports FireWire bus data transfer rates of 100, 200, and 400Mbps
- Hot-swapping feature allows you to connect and disconnect devices without shutting down operating system
- Supports Windows 7, Vista and XP



254478 / DS-33230
PCI, USB 2.0 / FireWire Combo interface card

DIGITUS® USB 2.0, PCI card



The quick and easy way to add extra USB Ports to your Computer

- 3 x external USB 2.0 type A/female (480Mbps)
- 1 x internal USB 2.0 type A/female (480Mbps)
- Chipset: VIA 6212
- Supports USB high speed (480Mbps), full speed (12Mbps), and low speed (1.5Mbps) data transfer modes
- Compliant with USB specification revision 2.0
- PCI 32-bit 33MHz interface
- Supports hot-swapping
- Operating systems supported: Windows 2000 / XP / Vista 32-bit/64-bit
- Accessories: 1 x manual, 1 x low profile bracket



254294 / DS-33221
PCI, USB 2.0 card, 3+1-ports

254317 / DS-33222
PCI, USB 2.0 card, 4+1-ports

DIGITUS® Firewire 800 / 400 Combo card, PCI



The quick and easy way to add extra Firewire Ports to your system

- 2 x FireWire 800 (1394b) 9-pin ports and 1x FireWire 400 (1394a) 6-pin port
- Chipsets: TI 82AA + 81BA3
- Data transfer rates of 100, 200, 400, and 800Mbps
- Supports hot-swapping and Plug and play connections of peripheral devices
- Bus interface: PCI bus 32/64bit
- Supports IEEE 1394b, downward compatible with IEEE 1394a
- Isochronous and asynchronous data transfer modes supported
- Works with various types of FireWire 800 (1394b) and FireWire 400 (1394a) devices, including external hard disk drives, DV camcorders, digital cameras, CD-RW/DVD-ROM drives, and other audio/video devices
- Accessories: 1 x manual, 1 x Ulead Video Studio CD
- Supports Windows 7, Vista and XP



254379 / DS-33205
PCI, FireWire 800/400 interface card, 2/1-ports

DIGITUS® Firewire A, PCI Cards

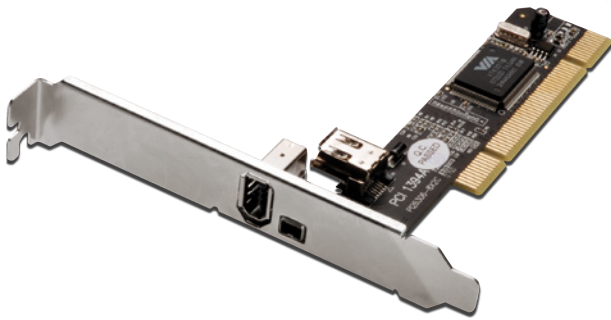

The quick and easy way to add extra Firewire Ports to your system

Extends PC connections with three Firewire ports. Connect easily, for example a DV camcorder or external enclosure, to your PC.

- Adds three IEEE1394a (FireWire) ports to your PC for high-speed I/O connectivity
- One (1) internal IEEE1394a port (Sharing with first external IEEE1394 port)
- External connections: 1x Firewire A, 6-pin/female, 1x Firewire A, 4-pin/female
- Internal connections: 1x Firewire A, 6-pin/female
- Compliant IEEE 1394-1995, 1394a (rev. 1.1) and OHCI Interface Specification 1.0
- Supports data transfer rates of 100, 200 and 400 Mbps
- PCI 32-bit 33MHz interface
- VIA VT6306 chipset
- Hot-swapping features allows you to connect/disconnect devices without powering down your system
- Package contents: 1x User Manual, 1x LowProfile bracket
- OS Supports: Windows 7, Vista 32-bit / Vista 64-bit, XP, 2000



252733 / DS-33201

PCI, Firewire A card, 2+1 ports

252740 / DS-33202

PCI, Firewire A card, 2+1 ports, incl. ULEAD software

DIGITUS® SATA to IDE adapter

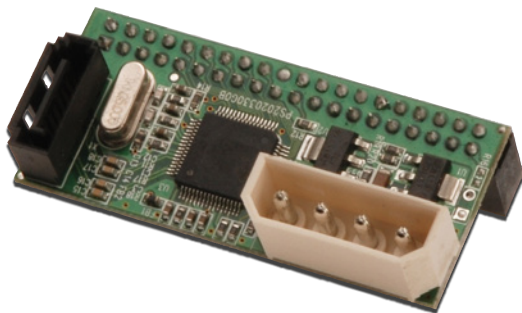

The perfect solution for adding IDE/ATA drives to motherboards with only available SATA controller

Allows you to use all kinds of IDE storage devices featuring 40-pin IDC connectors with a Serial ATA controller.

- Stand alone Serial ATA to Ultra ATA bridge board design
- Conforms to Serial ATA 1.0 specification, revision 2.2
- Chipset: JM20330
- Supports PIO mode 0-4
- Ultra ATA 133 / 100 / 66 / 33 supported
- Supports all types of ATAPI, ATA/133, ATA/100, ATA/66, ATA/33, EIDE and IDE storage devices (DVD, DVD-RAM, MO, CD-ROM, CD-RW, Hard Disk)
- Compact dimensions allowing direct connections to ATA hard drives
- Board design: horizontal version



244967 / DS-33150

SATA to IDE adapter

DIGITUS® Firewire A, PCI Cards

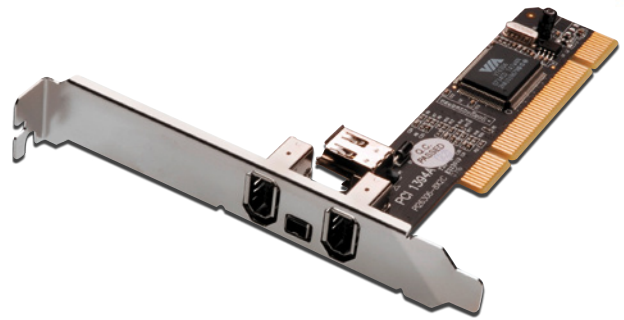

The quick and easy way to add extra Firewire Ports to your system

Add four Firewire-A ports to your PC - e.g. DV camcorders or external enclosures can easily be connected to your computer.

- Adds four IEEE1394a (FireWire) ports to your PC for high speed I/O connectivity
- One (1) internal IEEE1394a port (connection shared with first external IEEE1394 port)
- External connections: 2 x Firewire A, 6-pin/female, 1 x Firewire A, 4-pin/female
- Internal connections: 1 x Firewire A, 6-pin/female
- Compliant with IEEE 1394-1995, 1394a (rev. 1.1), and OHCI interface specification 1.0
- Supports data transfer rates of 100, 200, and 400 Mbps
- PCI 32-bit 33MHz interface
- Chipset: VIA VT6306
- Hot-swapping feature allows you to connect and disconnect devices without shutting down operating system
- Package contents: 1 x User Manual, 1 x Low profile bracket
- Supports Windows 7, Vista and XP



252757 / DS-33203

PCI, Firewire A card, 3+1 ports

252764 / DS-33204

PCI, Firewire A card, 3+1 ports, incl. ULEAD software

DIGITUS® IDE to SATA Adapter

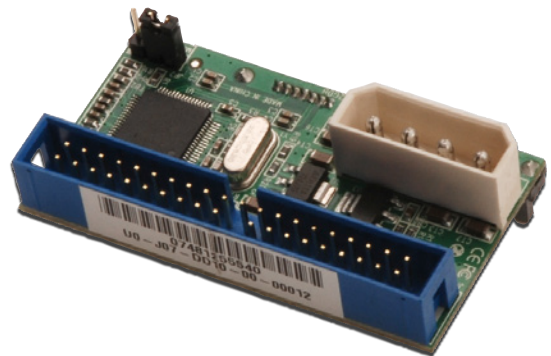

The perfect solution for adding SATA drives to motherboards without available SATA connectivity

Allows you to use all kinds of SATA storage devices with an IDE controller.

- Stand alone Ultra ATA to Serial ATA bridge board design
- Conforms to Serial ATA 1.0 specification, revision 2.2
- Chipset: JM20330
- Transfer rate: 1.5Gb/s
- Supports all types of SATA storage devices (DVD, DVD-RAM, MO, CD-ROM, CD-RW, Hard Disk, ...)
- Compact dimensions allowing direct connections to SATA hard drives
- Board design: horizontal version



244974 / DS-33151

IDE to SATA Adapter

DIGITUS® 2x Serial interface card, PCI

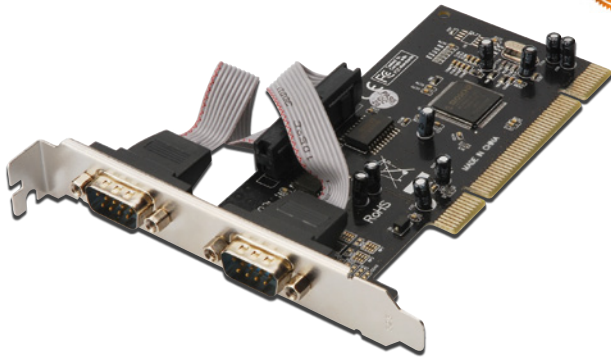

Perfect for connecting serial modems, PDAs, digital cameras, printers, ISDN terminal adapters and many more

This PCI based serial Add-On card allows you to turn a PCI slot into two RS232 (DB9) serial ports. Based on a native single chip design reduces the load applied to the CPU by as much as 48% over conventional serial cards.

- 2 x DSUB 9, serial ports, male
- Chipset: MCS9865
- Data transfer rate up to 115,2Kbps
- Universal PCI interface 3.3V & 5V, 32-bit/64-bit
- Compliant with PCI 33MHz, ver. 3.0/2.3/2.2/2.1 specification
- 128-bytes onboard FIFO buffer
- On-chip hardware autoflow control to guarantee no data loss
- Plug and play, I/O adress and IRQ assigned by BIOS



309369 / DS-33003

PCI, Serial interface card, 2 x DSUB 9

DIGITUS® 2ser. / 1par. interface card, PCI

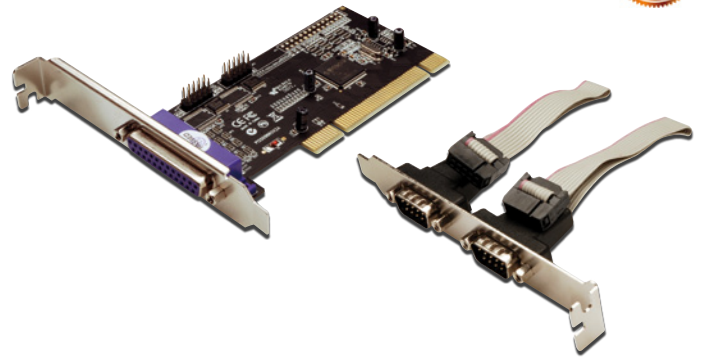

Perfect for connecting any parallel or serial device including printers, scanners and ISDN terminal adapters

Multi I/O PCI card

- 2 x DSUB 9, serial ports, male, UART16C450/550
- 1 x DSUB 25, parallel port, jack
- Chipset: MCS9865
- Serial data transfer rate up to 115,200bps
- Parallel data transfer rate up to 1.5Mbps
- Supports Standard Parallel Port (SPP), Enhanced Parallel Port (EPP) & Enhanced Capability Port (ECP)
- Compliant with PCI Local Bus specifications, Revision 2.3, 32-bit bus
- Easy plug and play
- Automatic assignment of IRQ and I/O addresses
- 1 x manual, 1 x driver CD, 1 x standard bracket with serial ports, 3 x low profile brackets included in delivery
- Supports Windows Vista/Server 2003/XP/2000



254362 / DS-33040

PCI, 2 ser. / 1 par. interface card



DIGITUS® parallel interface card, PCI

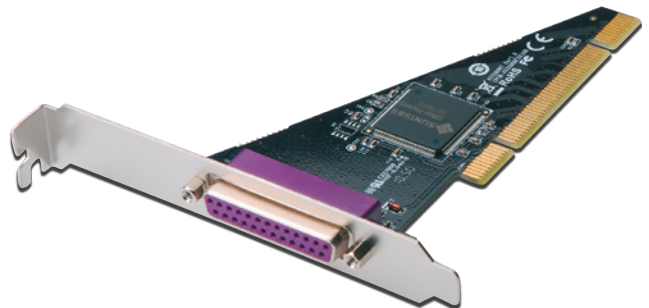

Take full advantage of all your high-speed parallel devices

- 1 x DSUB 25, parallel port, jack
- Chipset: 4037T-SUN1889 IC
- Data transfer rate up to 2.7Mbps
- Supports Standard Parallel Port (SPP), Bi-directional Parallel Port (BPP), Enhanced Parallel Port (EPP) & Enhanced Capability Port (ECP)
- Compatible with IEEE 1284 standards
- Universal PCI interface 3.3V & 5V, 32-bit/64-bit
- Plug and play
- Remap to ISA address 278, 378
- Operating systems supported: Windows CE / 98SE / ME / NT / 2000 / Server 2003 / Vista / Linux, and DOS
- 1 x manual, 1 x driver CD included in delivery



293002 / DS-33010-1

PCI, Parallel interface card 1x DSUB 25

DIGITUS® Ultra ATA 133 RAID Controller, PCI card

The affordable RAID solution for high-performance data storage

Extends your PC system by two additional IDE/ATA interface ports for up to four IDE/ATA devices.

Optionally useable as a standard IDE/ATA controller, or as a RAID controller which supports RAID 0, 1, 0+1, and JBOD functionality.

- 2 x Ultra ATA 133 IDE connectors for up to four IDE/ATA devices
- Compatible with ATA/ATAPI-6 specifications
- Supports Scatter/Gather function using DMA/UDMA
- Supports maximum PCI bus master data transfer rate of 66MB/Sec
- Fully backward compatible with Ultra ATA/133, EIDE/Fast ATA-2 IDE & ATAPI devices
- PCI bus 32-bit
- Silicon Image 0680 chipset
- Supports RAID 0, 1, 0+1 and JBOD functions
- Supports: Windows 7, Vista, XP

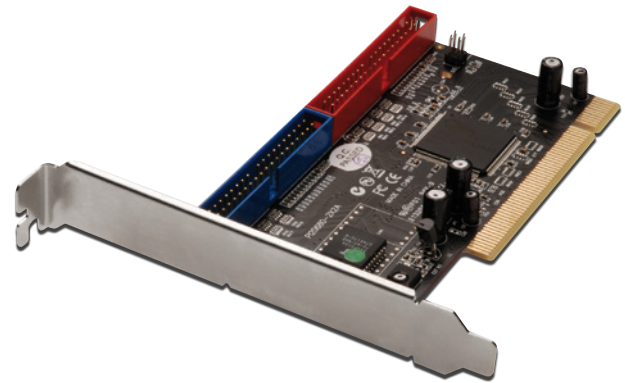
252702 / DS-33104

IDE ATA133 Raid Controller, PCI 32 bit

DIGITUS® SATA 150 RAID PCI card, 4-port

The quick and easy way to add Serial ATA performance to your PC

4 x internal Serial ATA connectors, 2 x external eSATA connectors (selectable)

- Chipset: Sil 3114
- Compliant with SATA, revision 1.0
- Stand-alone PCI to Serial ATA host controller
- Serial ATA generation 1, data transfer rate up to 150MB/sec
- Supports the following Raid levels: 0 = Disk Striping, 1 = Disk Mirroring, 5= Parity Raid, 1+0 = Combination of disk striping and disk mirroring
- Four independent Serial ATA channels, each of them supporting one connection of a Serial ATA device at the same time
- Supports hard drives larger than 137GB
- Compliant with PCI IDE Controller specifications, revision 2.3, 32-bit, 33/66Mhz
- Supports Windows 7, Vista and XP

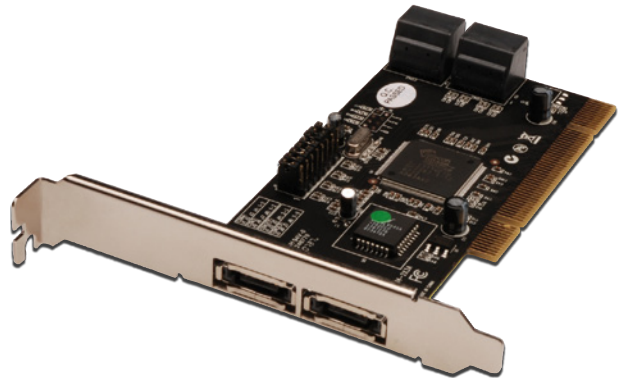
244981 / DS-33102

SATA 150 PCI card, 4-port RAID

DIGITUS® 7.1 PCI Sound Card

Enjoy the true multimedia surround sound experience

Full-duplex playback and recording

- Full-duplex 8CH DAC/2CH ADC
- Support 48/44.1 KHz sampling rate for both playback and recording
- Supports the latest Dolby® Digital EX and DTS ES 6.1/7.1 CH DVD soundtrack playback
- DirectSound™ 3 HW acceleration
- PCI Rev. 2.2 compliant with bus mastering modes
- ACPI compliant power down management
- System requirements: Pentium-class computer with one available PCI slot; DirectX 8.1 above is required
- Supports: Windows 7, Vista, XP

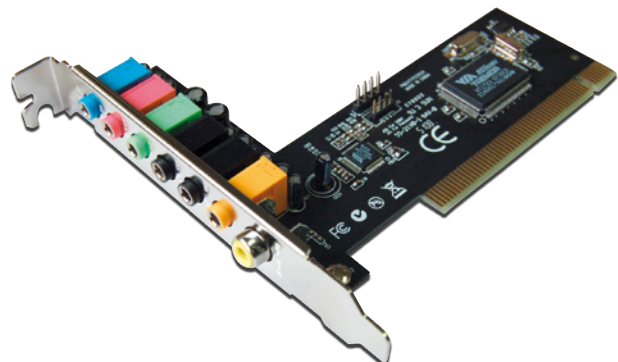
276517 / DS-33700

7.1 PCI Sound Card

DIGITUS® USB 2.0 , Cardbus



Easy Plug-and-Play installation

- 4 x USB 2.0 type A/female (480Mbps)
- 1 x DC jack (for optional power supply)
- Chipset: VIA 6212
- Data transfer rates: USB 1.1 OHCI 1.5Mbps, 12Mbps; USB 2.0 EHCI 480Mbps
- Bus interface: CardBus Type II, 32-bit 33MHz, 3.3V
- Compliant with USB 2.0 EHCI and USB 1.1 OHCI
- Supports hot-swapping and wake up function
- Supports Windows 7, Vista and XP



254324 / DS-32220
Cardbus, USB 2.0 card, 4-ports

DIGITUS® USB 2.0 / FireWire Combo card, Cardbus



Features high-speed USB and Firewire access for quick and efficient data transmission

- Combo card USB 2.0 and FireWire 400 (1394a)
- 2 x USB 2.0 type A/female (480Mbps), 1x FireWire 400 6-pin and 1x 4-pin Port (400Mbps)
 - 1 x DC jack (for optional power supply)
 - Chipsets: VIA 6212 + 6307
 - Bus interface: CardBus Type II
 - Compliant with USB specification revision 2.0
 - Full support of EHCI and OHCI compliant standards
 - Supports USB high speed (480Mbps), full speed (12Mbps), and low speed (1.5Mbps) data transfer modes
 - Compliant with IEEE 1394-1995, 1394a-2000, and OHCI 1.1 standards
 - Supports Windows 7, Vista and XP



254492 / DS-32230
Cardbus, USB 2.0 / FireWire Combo interface card

DIGITUS® Firewire 400, Cardbus



- 3 x FireWire 400 (IEEE1394a) 6-pin ports
- 1 x DC jack (for optional power supply)
 - Chipset: VIA 6306L
 - Data transfer rates of 100, 200, and 400Mbps
 - Bus interface: CardBus Type II, 32-bit 33MHz, 3.3V
 - Supports hot-swapping
 - Works with various types of FireWire 400 (1394a) devices, including external hard disk drives, DV camcorders, digital cameras, CD-RW/DVD-ROM drives, and other audio/video devices
 - Operating systems supported: Windows 98SE / ME / 2000 / XP / Vista 32-bit/64-bit and Mac OS 8.6 or higher
 - Accessories: 1 x manual
 - Supports Windows 7, Vista, XP, Mac OS X



254423 / DS-32200
Cardbus, Firewire 400 card, 3-ports

DIGITUS® serial interface card, Cardbus



Perfect for connecting serial modems, PDAs, digital cameras, printers, ISDN terminal adapters and more

- 1 x DSUB 9, serial port, male
- Chipset: Netmos 9820
- Data transfer rate up to 115,200bps
- Compatible with 32-bit CardBus slot
- CardBus Type II, 32-bit, 33MHz, 3.3V
- Easy installation, plug and play
- Simple solution to connect devices with your notebooks
- Supports Windows 7, Vista and XP



254416 / DS-32000
Cardbus, Serial interface card, 1 x DSUB 9

DIGITUS® parallel interface card, Cardbus



Take full advantage of all your high-speed parallel devices

- 1 x DSUB 25, parallel port, jack
- Chipset: MCS9805
- Data transfer rate up to 1.5Mbps supported
- Supports Standard Parallel Port (SPP), Enhanced Parallel Port (EPP) & Enhanced Capability Port (ECP)
- Compatible with 32-bit CardBus slot
- Easy installation, plug and play
- Simple solution to connect devices with your notebooks
- Supports Windows 7, Vista and XP



254454 / DS-32020
Cardbus, Parallel interface card 1 x DSUB 25



Wireless Projector Server

Presentation via Wireless LAN - quick - easy - comfortable!

Wireless integration of computers into your home cinema! The latest 11n wireless technology offers real image transmission to your projector, TV or monitor. You can watch photos in the highest quality in your home cinema. Make yourself comfortable! Instead of surfing the internet on your computer, transmit images to your TV! According to the motto „Technology must be fun!“ we emphasize the user friendly interface and the simple handling. Perfect presentations! The DIGITUS Wireless Presentation Server lifts your business meetings to a new level of performance. With the integrated access point you can transfer your presentations wirelessly in a user friendly way from your PC to a projector, TV, or monitor. With the VGA interface it is suitable for the most common devices. The software program is installed in only a few seconds. Start your presentations now - without any hassle or swapping! The heading presenter can choose whose turn it is.

- Wireless presentation of your computer projects on a projector, TV screen, or monitor
- Independent from video formats - The video is decoded on the computer directly
- No pre-installed software required - new users can download application from projector server directly and get it installed within 30 seconds.
- Supports all major TV and projector resolutions - 800x600, 1024x768, 1280x800 or 1400x1050
- Simultaneous content projection and web surfing - Integrated 300 Mbps Access Point
- WPS (Wi-Fi Protected Setup) function provides fast, easy, and secure wireless encryption
- Multiple user login supported
- Moderation of a meeting via network or via a push button on the device
- User friendly interface
- Inclusive remote controller
- VGA Video Output - Suitable for the most LCD or Plasma Displays and Projectors
- Audio Output with 3.5mm Stereo Jack
- You can connect external peripherals by USB to assist your presentation - like a wireless mouse
- Supports a direct USB Type B connection with Direct Show function (only for Windows) - Connect your PC directly to the Projector Server
- 10/100Mbps RJ45 LAN port for connections with local networks
- Supports Windows 7, Vista, XP and Mac OS X

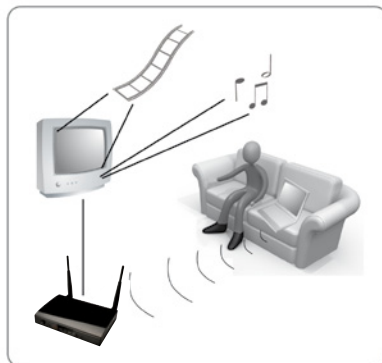

Dual Band 450N Wireless Access Point / Router

Dual Band - parallel using of 2.4GHz and 5GHz frequency bands for less interferences and a stable connection

Wireless LAN Speed up to 450 Mbps

- Supported Standards 802.11a/b/g/n Wireless LAN
- Dual Band - parallel using of 2.4GHz and 5GHz frequency bands for less interferences and a stable connection
- Transmission in the 2.4GHz and 5GHz frequency bands at the same time
- Offers Access Point, Client Mode, Universal Repeater and WDS functions
- Gigabit LAN Connection offers high Bandwidth for Wired Clients
- Advanced Security Features with WPA2/WPA/WEP Encryption, Firewall, MAC Filter and Protection against DoS-Attacks
- Supports WPS (WiFi Protected Setup) - Push button for auto connection to a wireless adapter (adapter must support this feature)
- A hardware switch offers switching on/off of the Wireless LAN
- Integrated Router
- Connection: 4x RJ45 LAN, 1x RJ45 WAN
- Advanced Features: Virtual Server, DMZ, DDNS, VPN pass through, Web User Interface, Port Trigger, Port Forwarding, Upgradeable Firmware
- Additional Features: PPPoE, Static IP, PPTP, DHCP, NAT
- Green Ethernet - Designed for low power consumption



311195 / DN-70690

Dual Band 450N Wireless Access Point / Router

Dual Band 300N Wireless Access Point / Router

Dual Band - parallel using of 2.4GHz and 5GHz frequency bands for less interferences and a stable connection

Wireless LAN Speed up to 300 Mbps

- Supported Standards 802.11a/b/g/n Wireless LAN
- Dual Band - parallel using of 2.4GHz and 5GHz frequency bands for less interferences and a stable connection
- Transmission in the 2.4GHz and 5GHz frequency bands at the same time
- Offers Access Point, Client Mode, Universal Repeater and WDS functions
- Gigabit LAN Connection offers high Bandwidth for Wired Clients
- Advanced Security Features with WPA2/WPA/WEP Encryption, Firewall, MAC Filter and Protection against DoS-Attacks
- Supports WPS (WiFi Protected Setup) - Push button for auto connection to a wireless adapter (adapter must support this feature)
- A hardware switch offers switching on/off of the Wireless LAN
- Integrated Router
- Connection: 4x RJ45 LAN, 1x RJ45 WAN
- Advanced Features: Virtual Server, DMZ, DDNS, VPN pass through, Web User Interface, Port Trigger, Port Forwarding, Upgradeable Firmware
- Additional Features: PPPoE, Static IP, PPTP, DHCP, NAT
- Green Ethernet - Designed for low power consumption



311201 / DN-70590

Dual Band 300N Wireless Access Point / Router

Wireless 450N Dual Band USB 2.0 Adapter

Provides further coverage, less dead spot and higher throughput for the best online and multimedia experience

High speed data transfer rate with up to 450 Mbps

- Complies with 2.4GHz/5GHz 802.11n and downwards compatible with IEEE 802.11a/b/g standards
- Supports 64/128-bit WEP, WPA and WPA2 Encryption with IEEE 802.1x functions
- Suitable for all common network environments
- Product dimensions: 87.1mm x 26.6mm x 18mm
- USB 2.0 compliant
- 2 internal antennas and 1 external antenna (3T3R)
- Ralink RT3573 Chipset
- Supports Windows 7, Vista and XP

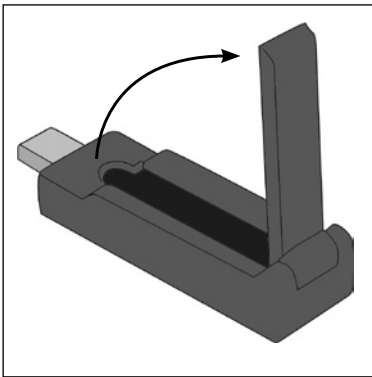

311188 / DN-70650

Wireless 450N Dual Band USB 2.0 Adapter

Wireless 300N Dual Band USB 2.0 Adapter

Provides further coverage, less dead spot and higher throughput for the best online and multimedia experience

High speed data transfer rate with up to 300 Mbps

- Complies with 2.4GHz/5GHz 802.11n and downwards compatible with IEEE 802.11a/b/g standards
- Dual Band - optionally using of 5GHz frequency band for less interferences and a stable connection
- Supports 64/128-bit WEP, WPA and WPA2 Encryption with IEEE 802.1x functions
- Suitable for all common network environments
- Product dimensions: 10mm x 27mm x 83mm
- USB 2.0 compliant
- 2 Antennas (2T2R)
- Ralink RT3572 Chipset
- Supports Windows 7, Vista and XP



311171 / DN-70550

Wireless 300N Dual Band USB 2.0 Adapter

DIGITUS® RedRapid X Wireless Modem Router

All you need for Internet access and networking in one smart package

Integrated modem ITU-T G.992.3 G.992.4 G.992.5 (ADSL2 / ADSL2+)

- Downstream up to 24Mbps and upstream up to 1Mbps
- Compatible to ADSL
- Wireless LAN Speed up to 300 Mbps
- Supported Standards 802.11b/g/n Wireless LAN
- Transmission in the 2.4GHz frequency band
- Offers Access Point and Universal Repeater
- Advanced Security Features with WPA2/WPA/WEP Encryption, Firewall,
- MAC Filter and Protection against DoS-Attacks
- Supports WPS (WiFi Protected Setup) - Push button for auto connection to a wireless adapter (adapter must support this feature)
- 2 detachable antennas with RP-SMA connector
- A hardware switch offers switching on/off of the Wireless LAN
- Integrated Router
- Connection: 4x RJ45 LAN, 1x RJ11 ADSL
- Advanced Features: Virtual Server, DMZ, DDNS, VPN pass through, Web User Interface, Port Trigger, Port Forwarding, Upgradeable Firmware



300 Mbit

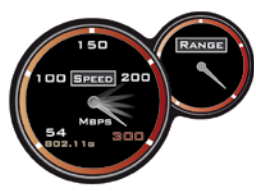

278061 / DN-7060
RedRapid X Wireless 300N ADSL+ Modem Router, Annex B

285618 / DN-7060-A
RedRapid X Wireless 300N ADSL+ Modem Router, Annex A

DIGITUS® WhiteRapid N+ PoE Access Point

Features PoE - no need for power cables, simplifies the installation

Wireless LAN Speed up to 300 Mbps

- Supported Standards 802.11b/g/n Wireless LAN
- Transmission in the 2.4GHz frequency band
- Offers Access Point, Client Mode, Universal Repeater and WDS functions
- Supports four sets of ESSID to group the different wireless networks
- Advanced Security Features with WPA2/WPA/WEP Encryption, Firewall,
- MAC Filter and Protection against DoS-Attacks
- Supports WPS (WiFi Protected Setup) - Push button for auto connection to a wireless adapter (adapter must support this feature)
- 2 detachable antennas with RP-SMA connector
- Connection: 1x RJ45 LAN
- Configuration via Web Interface
- Complies with the 802.3af PoE standard
- Two power supply options: Use Power over Ethernet (PoE) or the included power adapter



300 Mbit

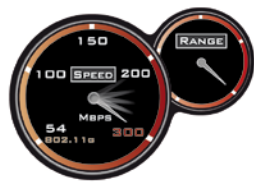

278054 / DN-7058
WhiteRapid N+ PoE Access Point

DIGITUS® BlackRapid N+ Wireless Access Point / Router

Offers incredible speed, range and wide coverage to your wireless network - ideal for HD video streaming, Multimedia and Gaming

Wireless LAN Speed up to 300 Mbps

- Supported Standards 802.11b/g/n Wireless LAN
- Transmission in the 2.4GHz frequency band
- Offers Access Point, Client Mode, Universal Repeater and WDS functions
- Advanced Security Features with WPA2/WPA/WEP Encryption, Firewall, MAC Filter and Protection against DoS-Attacks
- Supports WPS (WiFi Protected Setup) - Push button for auto connection to a wireless adapter (adapter must support this feature)
- 2 detachable antennas with RP-SMA connector
- A hardware switch offers switching on/off of the Wireless LAN
- Integrated Router
- Connection: 4x RJ45 LAN, 1x RJ45 WAN
- Advanced Features: Virtual Server, DMZ, DDNS, VPN pass through, Web User Interface, Port Trigger, Port Forwarding, Upgradeable Firmware
- Additional Features: PPPoE, Static IP, PPTP, DHCP, NAT



300 Mbit

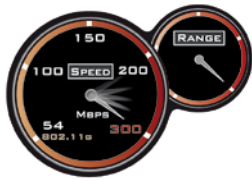

262190 / DN-7059-1
BlackRapid N+, 300N Router

DIGITUS® 150N Wireless Access Point / Router

With dedicated Wireless on/off switch - saves energy and prevents from unwanted radiation

Wireless LAN Speed up to 150 Mbps

- Supported Standards 802.11b/g/n Wireless LAN
- Transmission in the 2.4GHz frequency band
- Offers Access Point, Client Mode, Universal Repeater and WDS functions
- Advanced Security Features with WPA2/WPA/WEP Encryption, Firewall, MAC Filter and Protection against DoS-Attacks
- Supports WPS (WiFi Protected Setup) - Push button for auto connection to a wireless adapter (adapter must support this feature)
- A hardware switch offers switching on/off of the Wireless LAN
- Integrated Router
- Connection: 4x RJ45 LAN, 1x RJ45 WAN
- Advanced Features: Virtual Server, DMZ, DDNS, VPN pass through, Web User Interface, Port Trigger, Port Forwarding, Upgradeable Firmware
- Additional Features: PPPoE, Static IP, PPTP, DHCP, NAT
- Green Ethernet - Designed for low power consumption



310938 / DN-70490
150N Wireless Access Point / Router

DIGITUS® Wireless 300N USB antenna adapter



Most flexible with detachable antenna

High speed data rate with up to 300Mbps

- Complies with 2.4GHz 802.11n and downwards compatible with IEEE 802.11g/b standards
- Detachable 3dBi antenna with RP-SMA connector
- Advanced Security Features with WPA2/WPA/WEP Encryption
- Suitable for all common network environments
- Supports WPS (WiFi Protected Setup)
- Compatible to USB 1.1 and USB 2.0 interface
- Status LEDs for Link and data transfer
- 1 Transmission Channel / 2 Receiver Channel
- Supports Windows 7, Vista, XP, Mac OS X and Linux
- **Connectable with DN-70105 for higher range**



307341 / DN-70540

Wireless 300N USB antenna adapter

DIGITUS® Wireless 300N ExpressCard adapter

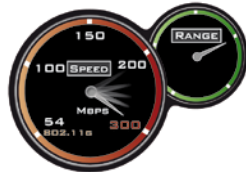

Experience superior Wireless connectivity with high-speed and extended coverage - ideal for HD video streaming and rich multimedia applications

This ExpressCard adapter complies with 802.11n next generation wireless standard. Utilizing the advanced MIMO technology, it can support the data transmission rate of up to 300Mbps and the coverage distance is far than IEEE 802.11g/b products. Stable wireless connection and high bandwidth enable you to enjoy rich media network applications without any interruption.

- High-speed data rate - up to 300Mbps
- Complies with 2.4GHz 802.11n and downwards compatible with IEEE 802.11g/b standards
- Supports 64/128-bit WEP Encryption and WPA-PSK, WPA2-PSK Security
- Suitable for all common network environments
- Supports advanced MIMO technology, enhancing the throughput and coverage range significantly
- Supports QoS-WMM, WMM-PS function to meet the multimedia data bandwidth requirements
- Supports WPS (WiFi Protected Setup)
- ExpressCard interface
- Status LEDs for Link and data transfer
- Supports Windows 7, Vista and XP



221876 / DN-7052

Wireless 300N ExpressCard adapter

DIGITUS® Wireless 300N USB adapter

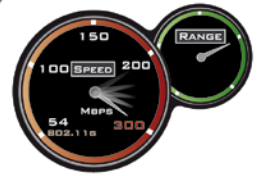

Provides further coverage, less dead spot and higher throughput for the best online and multimedia experience

High speed data rate with up to 300Mbps

- Complies with 2.4GHz 802.11n and downwards compatible with IEEE 802.11g/b standards
- Supports WPS (WiFi Protected Setup) - Push button for auto connection to the network
- Supports 64/128-bit WEP, WPA and WPA2 Encryption
- Suitable for all common network environments
- Product dimensions: (W x D x H): 2.4cm x 5.2cm x 1.0cm
- 2 Antennas (1T2R)
- Supports Windows 7, Vista, XP, Mac OS X and Linux



285328 / DN-7053-2

Wireless 300N USB adapter

DIGITUS® Wireless 300N PCI adapter

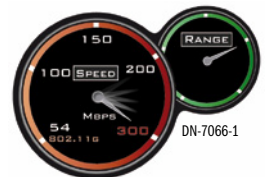
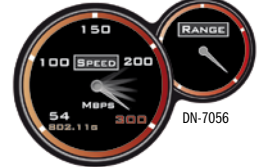

Maximize your Wireless Network in Range and Speed with the 802.11n standard

High speed data rate with up to 300Mbps

- Complies with 2.4GHz 802.11n and downwards compatible with IEEE 802.11g/b standards
- Supports WPS (WiFi Protected Setup) - Push button for auto connection to the network
- Supports 64/128-bit WEP, WPA and WPA2 Encryption
- Suitable for all common network environments
- 32-bit PCI interface
- Status LEDs for Link and data transfer
- Supports Windows 7, Vista, XP and Mac OS 10.x



279600 / DN-7066-1

Wireless 300N PCI adapter, 2 antennas

221845 / DN-7056

Wireless 300N PCI adapter, 3 antennas

DIGITUS® Wireless 150N USB adapter

Smallest Wireless LAN USB Adapter - Plug it in once and forget about it!

High speed data rate with up to 150Mbps

- Complies with 2.4GHz 802.11n and downwards compatible with IEEE 802.11g/b standards
- Supports 64/128-bit WEP, WPA and WPA2 Encryption
- Suitable for all common network environments
- Product dimensions: (W x D x H): 1.5cm x 1.9cm x 0.7cm
- Compatible to USB 1.1 and USB 2.0 interface
- Status LEDs for Link and data transfer
- 1 Antenna (1T1R)
- Supports Windows 7, Vista, XP and Mac OS 10.x



Tinysize



2301691 / DN-7042-1
Wireless 150N USB adapter

DIGITUS® Wireless 150N USB adapter

Enjoy proven Wireless N speed and reliability in a compact design

High speed data rate with up to 150Mbps

- Complies with 2.4GHz 802.11n and downwards compatible with IEEE 802.11g/b standards
- Supports 64/128-bit WEP, WPA and WPA2 Encryption
- Suitable for all common network environments
- Product dimensions: 59mm x 19mm x 9mm
- USB 2.0 compliant
- 1 Antenna (1T1R)
- Realtek Chipset
- Supports Windows 7, Vista, XP, Mac OS X and Linux

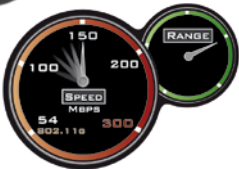
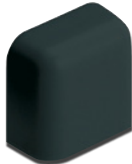

291640 / DN-7045
Wireless 150N USB adapter



**Enjoy connections.
Live.**

DIGITUS® Wireless 150N USB antenna adapter

Most flexible with detachable antenna

High speed data rate with up to 150Mbps

- Complies with 2.4GHz 802.11n and downwards compatible with IEEE 802.11g/b standards
- Detachable 3dBi antenna with RP-SMA connector
- Advanced Security Features with WPA2/WPA/WEP Encryption
- Suitable for all common network environments
- Supports WPS (WiFi Protected Setup)
- Compatible to USB 1.1 and USB 2.0 interface
- Status LEDs for Link and data transfer
- 1 Transmission Channel / 1 Receiver Channel
- Supports Windows 7, Vista, XP, Mac OS X and Linux



307358 / DN-70440

Wireless 150N USB antenna adapter

DIGITUS® Wireless 150N USB antenna adapter

Best Wireless LAN connectivity and coverage due to the integrated high performance antenna

High speed data rate with up to 150Mbps

- Complies with 2.4GHz 802.11n and downwards compatible with IEEE 802.11g/b standards
- Integrated 3 dBi antenna
- Supports 64/128-bit WEP, WPA and WPA2 Encryption
- Suitable for all common network environments
- Supports QoS-WMM, WMM-PS function to meet the multimedia data bandwidth requirements
- Supports WPS (WiFi Protected Setup) - Push button for auto connection to the network
- Compatible to USB 1.1 and USB 2.0 interface
- Status LEDs for Link and data transfer
- 1 Antenna (1T1R)
- Supports Windows 7, Vista, XP and Mac OS 10.x



262909 / DN-7044

Wireless 150N USB adapter

264569 / DN-7044-1

Wireless 150N USB adapter with USB docking ball

DIGITUS® Wireless 150N PCI adapter

Up to three times faster than Wireless G solutions!

High speed data rate with up to 150Mbps

- Complies with 2.4GHz 802.11n and downwards compatible with IEEE 802.11g/b standards
- Supports WPS (WiFi Protected Setup) - Push button for auto connection to the network
- Supports 64/128-bit WEP, WPA and WPA2 Encryption
- Suitable for all common network environments
- 32-bit PCI interface
- Status LEDs for Link and data transfer
- Supports Windows 7, Vista, XP and Mac OS 10.x

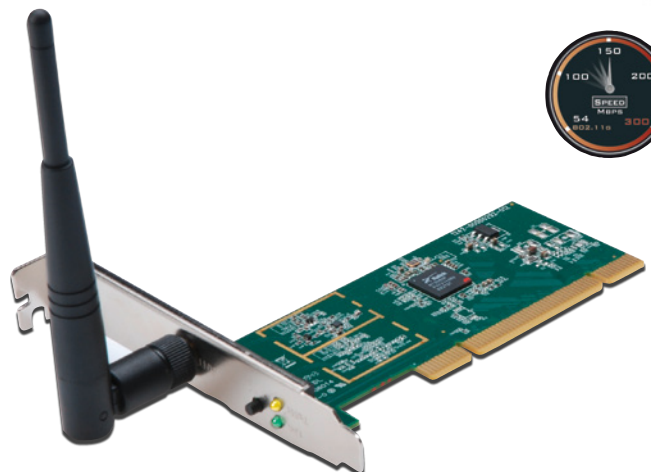

279617 / DN-7046-1

Wireless 150N PCI adapter

DIGITUS® Wireless LAN rod antenna



Expands the Wireless LAN in range and coverage - Improves the wireless signal quality

Wireless LAN high performance rod antenna

- Frequency range: 2.4GHz - 2.4835GHz
- Gain: 5dBi (reception)
- Omnidirectional
- Suitable for 2.4GHz Wireless LAN
- Connection via RP-SMA socket
- Length: 19.7cm, diameter: 12mm
- Suitable for all DIGITUS Wireless LAN products
- Suitable stands for antenna: DN-70101 or DN-70106

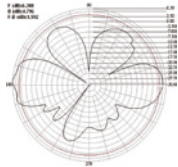

179221 / DN-70100
Wireless LAN rod antenna, 5 dBi

DIGITUS® Wireless LAN rod antenna

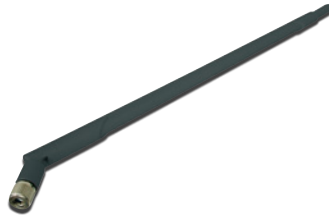

Expands the Wireless LAN in range and coverage - Improves the wireless signal quality

Wireless LAN high performance rod antenna

- Frequency range: 2.4GHz - 2.4835GHz
- Gain: 7 dBi (reception)
- Omnidirectional
- Suitable for 2.4GHz Wireless LAN
- Connected via RP-SMA socket
- Length: 30cm
- Diameter: 1.3cm
- Suitable for all DIGITUS Wireless LAN products
- Suitable stand: DN-70106

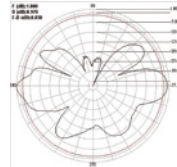

200550 / DN-70104
Wireless LAN rod antenna, 7 dBi

DIGITUS® Wireless LAN rod antenna



Expands the Wireless LAN in range and coverage - Improves the wireless signal quality

- Frequency range: 2.4GHz - 2.4835GHz
- Omnidirectional
- Gain: 9 dBi (reception)
- Suitable for 2.4GHz Wireless LAN
- Connected via RP-SMA socket
- Length: 38.5cm
- Diameter: 1.3cm
- Suitable for all DIGITUS® Wireless LAN products
- Suitable stand: DN-70106
- e.g. as additional repeater for DN-70540

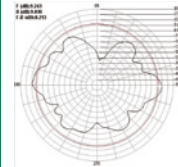

200567 / DN-70105
Wireless LAN rod antenna, 9 dBi

DIGITUS® Wireless LAN flat antenna



Expands the Wireless LAN in range and coverage - Improves the wireless signal quality

Wireless LAN high performance flat antenna

- Frequency range: 2.4GHz - 2.4835GHz
- Gain: 5 dBi (reception)
- Omnidirectional
- Suitable for 2.4GHz Wireless LAN
- Connection via RP-SMA socket
- Dimensions: 16.5x2.6x0.6cm
- Delivery includes hook and loop fastener
- Suitable for use with all DIGITUS Wireless LAN products

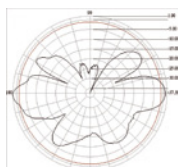

233497 / DN-70107
Wireless LAN flat antenna, 5dBi

DIGITUS® Wireless LAN patch antenna



Expands the Wireless LAN in range and coverage - Improves the wireless signal quality

Wireless LAN high performance patch antenna

- Frequency range: 2.4GHz - 2.4835GHz
- Gain: 10dBi (reception)
- Directional antenna
- Suitable for 2.4GHz Wireless LAN
- Connection via RP-SMA socket
- Dimensions: 10cm x 7.5cm x 2.2cm
- Adjustable wall bracket and adaptor included in delivery
- Can be used indoors and outdoors
- Suitable for all DIGITUS Wireless LAN products

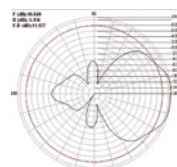

187530 / DN-70102
Wireless LAN patch antenna, 10 dBi

DIGITUS® Wireless LAN sector antenna



Expands the Wireless LAN in range and coverage - Improves the wireless signal quality

Wireless LAN heavy-duty sector antenna

- Frequency range: 2.4GHz - 2.4835GHz
- Gain: 12dBi (reception)
- Impedance: 50 ± 5
- Directional antenna
- Polarization: Vertical
- Weight: 300g ± 20g
- Connector type: RP-SMA socket
- Cable Type: RG-316
- Cable length: 1m
- Dimension: 23.3x11x5cm
- Color: grey
- Suitable for use with all DIGITUS Wireless LAN products

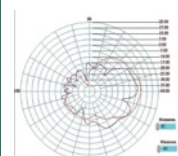

192749 / DN-70103
Wireless LAN sector antenna, 12 dBi

DIGITUS® Magnetic stand for Wireless LAN antennas

Expands the Wireless LAN in range and coverage
- Improves the wireless signal quality

Suitable for 2.4 GHz Wireless LAN - for all DIGITUS® Wireless LAN Products

- RP-SMA connectors
- Strong magnetic metal stand
- Cable length 1.50m
- Low loss cable



271192 / DN-70101-1

Magnetic stand for Wireless LAN antennas

DIGITUS® Stand for Wireless LAN antennas

Expands the Wireless LAN in range and coverage
- Improves the wireless signal quality

Suitable for 2.4 GHz Wireless LAN - for all DIGITUS® Wireless LAN Products

- RP-SMA connectors
- Cable length: 0.75m
- Low loss cable



200574 / DN-70106

Stand for Wireless LAN antennas



Wireless LAN coaxial cable CFD200 - low loss

SMA reversed jack to SMA reversed plug

- Signal loss 0,3dB/m
- Gold plated contacts
- CFD200 coaxial cable



285083 / DB-560200-010-S

Wireless LAN coaxial cable 1m, low loss

285144 / DB-560200-020-S

Wireless LAN coaxial cable 2m, low loss

285151 / DB-560200-030-S

Wireless LAN coaxial cable 3m, low loss

285168 / DB-560200-050-S

Wireless LAN coaxial cable 5m, low loss

285175 / DB-560200-100-S

Wireless LAN coaxial cable 10m, low loss

Antenna adapter RP TNC to RP SMA

Antenna adapter to connect RP SMA antenna with devices based on RP TNC connector

- TNC male reverse to SMA female reverse
- Length 5cm
- To connect some types of Linksys router with standard antenna



285182 / DB-560400-005-S

Antenna adapter RP TNC to RP SMA

Antenna adapter IPEX to SMA

Antenna adapter to connect SMA antenna with devices based on IPEX connector

- IPEX to SMA female reverse
- Length 10cm
- For example to connect a Fritzbox router with standard antenna

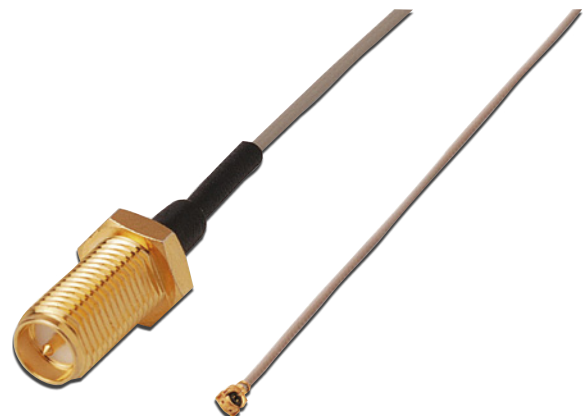

285199 / DB-560401-010-E

Antenna adapter IPEX to SMA

DIGITUS® High-speed Powerline Ethernet adapter, 500 Mbps

The easy Plug and Play adapter expands powerline network and offers network access from any power outlet

Adapter with network connection (RJ-45) for shared Internet access via DSL modem over the existing indoor power network

- Data transmission rates of up to 500Mbps over the building's own power network
- Gigabit Ethernet Network Connection
- Range of up to 300 meters across rooms and floors
- Bug proof security through integrated encryption process
- Particularly compact shape - no larger than a plug-in power adapter
- Compliant to the Home Plug AV standard
- Also suitable for game consoles with Ethernet connection or IPTV Set-Top-Boxes



302223 / DN-15024

High-speed Powerline Ethernet adapter, 500 Mbps

302230 / DN-15025

High-speed Powerline Ethernet adapter, 500 Mbps

DIGITUS® High-speed Powerline Ethernet adapter, 200 Mbps

The easy Plug and Play adapter expands powerline network and offers network access from any power outlet

Adapter with network connection (RJ-45) for shared Internet access via DSL modem over the existing indoor power network

- Data transmission rates of up to 200Mbps over the building's own power network
- Range of up to 300 meters across rooms and floors
- Bug proof security through integrated encryption process
- Particularly compact shape - no larger than a plug-in power adapter
- Compliant to the Home Plug AV standard
- Also suitable for game consoles with Ethernet connection
- Security push button for software free configuration
- Power packet utility provides unsophisticated users a way to graphically manage



309802 / DN-15026

High-speed Powerline Ethernet adapter, 200 Mbps

309819 / DN-15027

High-speed Powerline Starter Kit, 200 Mbps



DIGITUS® High-Speed 300N Powerline Access Point

Make power outlet become a Wireless LAN access point in your preferred room

This product features a wireless LAN access point and a Powerline adapter in a single device! It offers numerous and flexible opportunities to create or extend a local / in-house network by making wireless LAN available even in distant parts of your house. Plug and play - this device can easily be installed as an extension of your existing in-house power supply system - there is no need to reinstall your cable system! This device turns every wall socket in your house into a wireless access point, connecting it with the internet or a local network!

- 300 Mbps wireless LAN access point
- 200 Mbps Powerline adapter
- Highest security features due to the support of all common encryption methods
- Extension of existing wireless LAN networks featured by the WDS Repeater mode
- Compliant with Wireless LAN IEEE 802.11b/g/n standards
- Provides 128-bit AES Link Encryption with key management for secure Powerline communications
- Integrated enhanced Quality of Service (QoS) features
- Web user interface (remote configuration)
- Supports WPS (WiFi Protected Setup) - Push button for auto connection to the network
- Particularly compact shape - no larger than a plug-in power adapter
- Compliant to the Home Plug AV standard
- Also suitable for game consoles with Ethernet connection



276524 / DN-15018-1
High-Speed 300N Powerline Access Point

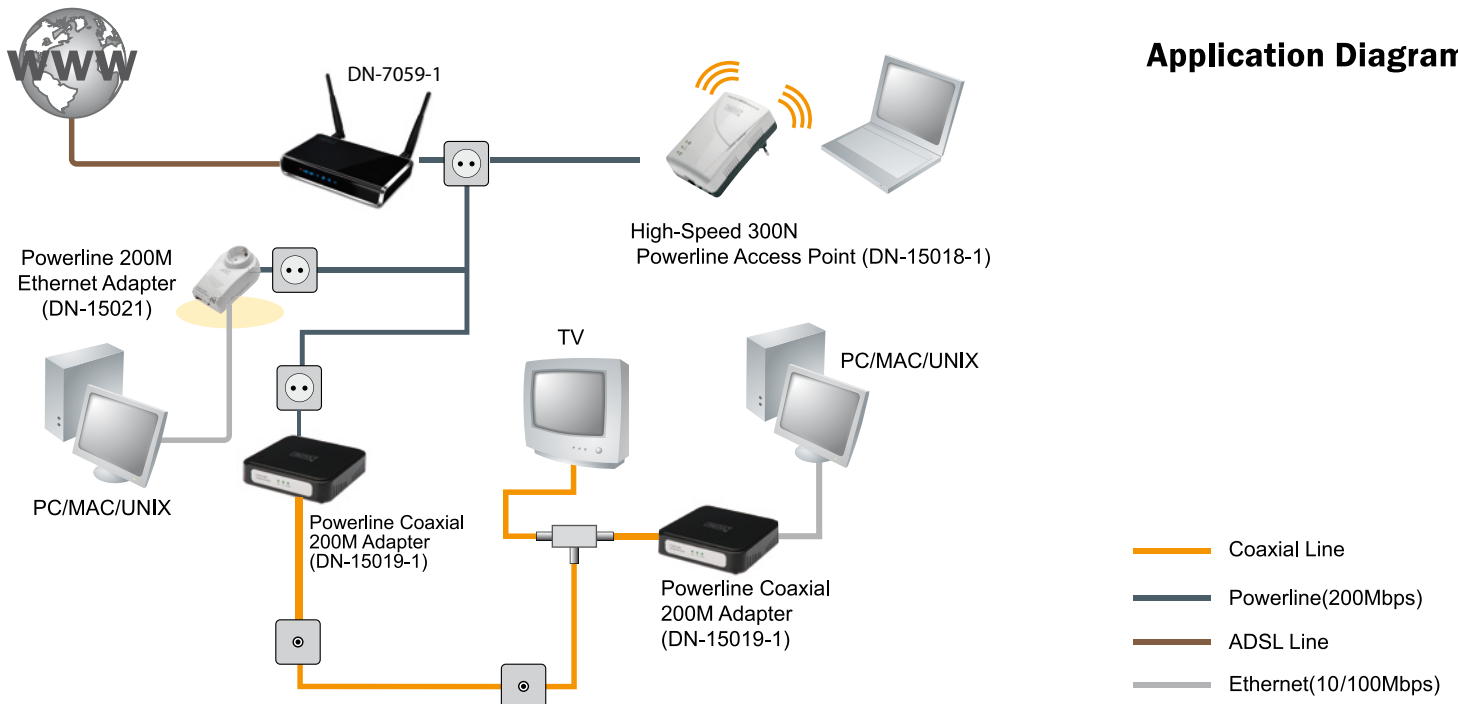

Application Diagram

DIGITUS® BlackRapid 1000 Switch

Brings Gigabit speed and bandwidth to your existing network

DIGITUS housing design

- IEEE802.3 Ethernet, IEEE802.3u Fast Ethernet, IEEE802.3ab Gigabit Ethernet compatible
- Automatic speed and half / full duplex recognition / adjustment
- 20 / 200 / 2000 Mbit in full duplex mode
- Auto MDI / MDI-X function
- External power supply



251750 / DN-80071
5-port Gigabit Ethernet BlackRapid 1000 Switch

251743 / DN-80061
8-port Gigabit Ethernet BlackRapid 1000 Switch

DIGITUS® Gigabit Switch N-Way

Best for quick and easy network expansion!

10/100/1000Mbps Gigabit Ethernet Switch

- Compliant to the network standards IEEE 802.3, IEEE 802.3u and IEEE 802.3ab
- Auto-Negotiation for 10/100/1000Mbps
- Auto-MDI/MDI-X for cable detection
- Advanced store-and-forward packet switching ensures an optimized data transfer
- External power supply



293453 / DN-80072
Gigabit Switch N-Way 5-port

293446 / DN-80062
Gigabit Switch N-Way 8-port

DIGITUS® Gigabit Ethernet 16-Port Switch

Ideal for sharing workgroups with multiple high-speed servers!

16-port 10/100/1000Mbps Gigabit Ethernet Switch

- Compliant to the network standards IEEE 802.3, IEEE 802.3u, IEEE 802.3ab and IEEE 802.3x
- Provides non-blocking, non-head-of-line forwarding
- Supports back pressure and bandwidth control on each port
- Advanced store-and-forward packet switching ensures an optimized data transfer
- Auto-Negotiation for 10/100/1000Mbps
- Auto-MDI/MDI-X for cable detection
- Provides 16K MAC address and 4 Mbit RAM buffer
- Power, Link/Active, Speed indicators for network status
- 483mm (19") Rack Mount Kit included



293460 / DN-80100
Gigabit Ethernet 16-port Switch

DIGITUS® Gigabit Ethernet 24-port Switch

Ideal for sharing workgroups with multiple high-speed servers!

24-port 10/100/1000Mbps Gigabit Ethernet Switch

- Compliant to the network standards IEEE 802.3, IEEE 802.3u, IEEE 802.3ab and IEEE 802.3x
- Provides non-blocking, non-head-of-line forwarding
- Supports back-pressure and 802.3x Flow control
- Advanced store-and-forward packet switching ensures an optimized data transfer
- Auto-Negotiation for 10/100/1000Mbps
- Auto-MDI/MDI-X for cable detection
- Provides 16K MAC address and 4 Mbit RAM buffer
- Power, Link/Active, Speed indicators for network status
- 483mm (19") Rack Mount Kit included



293477 / DN-80110
Gigabit Ethernet 24-port Switch

DIGITUS® Gigabit Ethernet PCI network card

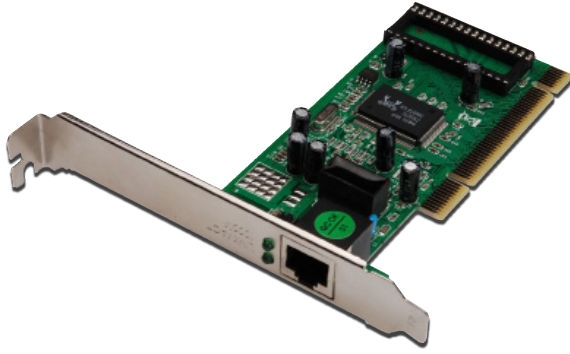

Unprecedented speed is now available over your existing network cabling - Built to run the fastest network applications.

Supports 10/100/1.000 Mbps auto negotiation.

- IEEE 802.3, IEEE 802.3u, IEEE 802.3ab compatible
- IEEE 802.3x full-duplex Flowcontrol
- Supports Autonegotiation and Crossover detection
- Realtek Chipset
- PCI Local Bus Master Rev.2.1 and 2.2 compatible
- Suitable for all common network environments
- Additional Low Profile Bracket to use the Card also in Thin Computers
- Supports Windows 7, Vista, XP, Mac OS X and Linux



310778 / DN-10110
Gigabit Ethernet PCI network card

DIGITUS® Gigabit Ethernet PCI Express network card

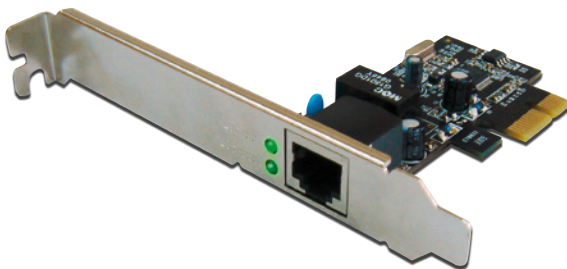

Unprecedented speed is now available over your existing network cabling - Built to run the fastest network applications

Compliant with 10/100/1.000 IEEE 802.3 specification

- Supports 10/100/1.000 Mbps auto negotiation
- Chipset: Realtek RTL8111DL
- Supports Auto MDI/MDIX crossover at all speed
- Compliant with PCI Express Base Specification 1.0a
- Installable in any available PCI Express slot with different lane widths
- Supports Wake On LAN (WOL) power management
- Supports Windows 7, Vista, XP and Mac OS 10.x



276555 / DN-1013-2
Gigabit Ethernet PCI Express network card

DIGITUS® USB 2.0 to Gigabit Ethernet Adapter



Integrate your computer into a Gigabit Ethernet network!

This USB to Gigabit Ethernet adapter enables you to convert any USB port to an Ethernet port. Thanks to this, you can connect your PC or notebook easily to your home network system or internet router. Therefore, you can share data within your network and enjoy multiplayer gaming.

- Ethernet IEEE 802.3, 802.3u and 802.3ab (10Base-T, 100Base-TX and 1000 Base-T) compatible, with auto negotiation
- Auto-MDI(X) capable (straight and cross network cable auto-detection)
- Supports USB 2.0 Full Speed and High Speed (USB bus powered)
- Supports „Full-duplex“ and „Half-duplex“ operation
- LAN 7500 chipset
- 1 x RJ-45 (STP) port, USB female type A
- USB bus powered, plug and play
- LED status indicators
- Suitable for all common network environments
- Supports Windows 7, Vista, XP, Mac OS X and Linux



306313 / DN-10150
USB 2.0 to Gigabit Ethernet Adapter

DIGITUS® Gigabit Ethernet ExpressCard



Unprecedented speed is now available over your existing network cabling - Built to run the fastest network applications

The DIGITUS GIGABIT ExpressCard connects your Notebook to the world of GIGABIT LAN speed!

- 1 x RJ 45 connector for 10/100/1000Mbps transmissions
- Chipset: Realtek 8111DL
- ExpressCard, form factor 34
- Supports Full Duplex flow control
- Fully compliant with IEEE 802.3, IEEE 802.3u, IEEE 802.3ab
- Fully compliant with ExpressCard Specification 1.0
- Supports Wake On LAN (WOL) power management (optional)
- LEDs indicate activity and data transmissions
- Supports Windows 7, Vista and XP



276562 / DN-10141-1
Gigabit Ethernet ExpressCard

DIGITUS® BlackRapid 100 Switch

Expand your home network - Adds up to five network devices like computers, printers, game consoles, hard disks, cameras, etc.

Housing in DIGITUS design

- IEEE 802.3 and IEEE 802.3u compatible
- 20/200Mbit full duplex
- Automatic speed and half/full duplex detection/configuration
- Store and forward architecture
- Auto MDI/MDI-X function
- External power supply
- Externes Netzteil



251729 / DN-50011
5-Port Fast Ethernet BlackRapid 100 Switch

251736 / DN-50021
8-Port Fast Ethernet BlackRapid 100 Switch

DIGITUS® Fast Ethernet N-Way desktop switch

5-port 10/100Mbps Fast Ethernet Switch

- Compliant to the network standards IEEE 802.3 and IEEE 802.3u
- Auto-Negotiation for 10/100Mbps
- Auto-MDI/MDI-X for cable detection
- Advanced store-and-forward packet switching ensures an optimized data transfer



DN-50012



DN-50022



272786 / DN-50012
Fast Ethernet N-Way 5-port desktop switch

272793 / DN-50022
Fast Ethernet N-Way 8-port desktop switch



DIGITUS® Fast Ethernet Switch N-Way 16-port

Ideal for sharing workgroups with multiple high-speed servers!

16 RJ45 ports

- Up to 20/200 Mbps in Full Duplex Mode
- Compatible to the following standards: IEEE 802.3, 802.3u, 802.3az and 802.3x
- Very low power consumption due to the EEE (Energy Efficient Ethernet) Technology
- Automatic Cable detection - Auto MDI / MDI-X function
- 8K MAC addresses
- Auto-Negotiation of Full- and half-duplex
- Power, Link/Active, Speed indicators for network status
- Shielded Metal Housing
- Noiseless design - without fan
- Built-in Power Supply
- Suitable for rack mount (incl. mounting bracket)



293422 / DN-60011-1

Fast Ethernet Switch N-Way 16 Port

DIGITUS® Fast Ethernet N-Way 24-port switch

Ideal for sharing workgroups with multiple high-speed servers!

24 RJ45 ports

- Up to 20/200 Mbps in Full Duplex Mode
- Compatible to the following standards: IEEE 802.3, 802.3u, 802.3az and 802.3x
- Very low power consumption due to the EEE (Energy Efficient Ethernet) Technology
- Automatic Cable detection - Auto MDI / MDI-X function
- 8K MAC addresses
- Auto-Negotiation of Full- and half-duplex
- Power, Link/Active, Speed indicators for network status
- Shielded Metal Housing
- Noiseless design - without fan
- Built-in Power Supply
- Suitable for rack mount (incl. mounting bracket)



293439 / DN-60021-1

Fast Ethernet N-Way 24-port switch

DIGITUS® Fast Ethernet PCI network card

Turns your Desktop PC into a high-bandwidth workstation or a power server running at full-duplex speed

Realtek chipset

- IEEE 802.3 and IEEE 802.3u compatible
- Supports 20/200 Mbps full duplex
- PCI Local Bus Rev.2.1 and 2.2 compatible
- Suitable for all typical network environments

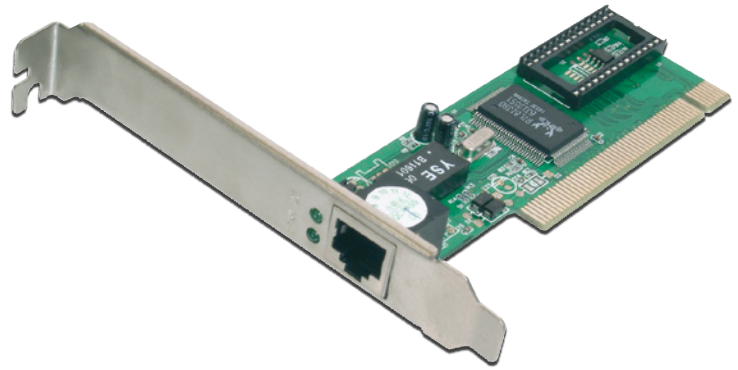

228677 / DN-1001J

Fast Ethernet PCI network card

DIGITUS® Fast Ethernet USB 2.0 adapter

Easily connect your computer, game console, or other device to a wired network

Ethernet IEEE 802.3 10BaseT compatible

- USB 2.0 high speed (up to 100Mbps)
- 1 x RJ45 port, USB female type A
- Chipset: MCS7832
- Plug and play
- Power supply via USB bus
- Suitable for all typical network environments
- Supports Windows 7, Vista, XP, Mac OS X and Linux



287889 / DN-10050

Fast Ethernet USB 2.0 adapter

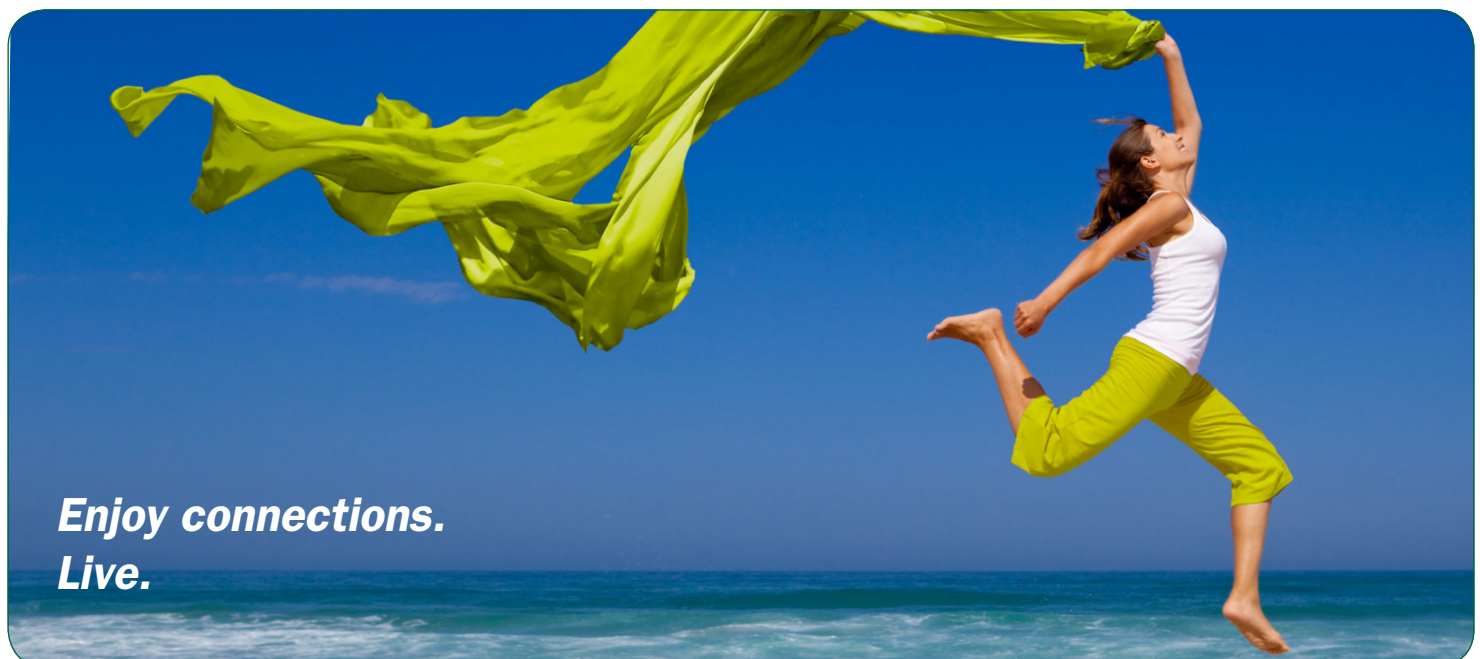

*Enjoy connections.
Live.*



DIGITUS® network USB hub

Use and share USB devices over the network - wherever you want

Easy configuration over web-interface

- Integrates 4 USB 2.0 high speed devices in the network
- No differences compared to directly connected devices
- Supports printers, USB speakers, hard drives, flash memory drives, card readers as well as a lot of other devices
- Monitoring the connected USB devices over a web browser or the included software
- Use the connected USB devices with any computer in the network, whether the connection is done via cable or wireless
- 4 x USB 2.0 Ports
- Downwards compatible to legacy USB devices
- LAN: 10/100 Mbps
- DHCP Client for easy network configuration
- Supports Windows 7, Vista and XP

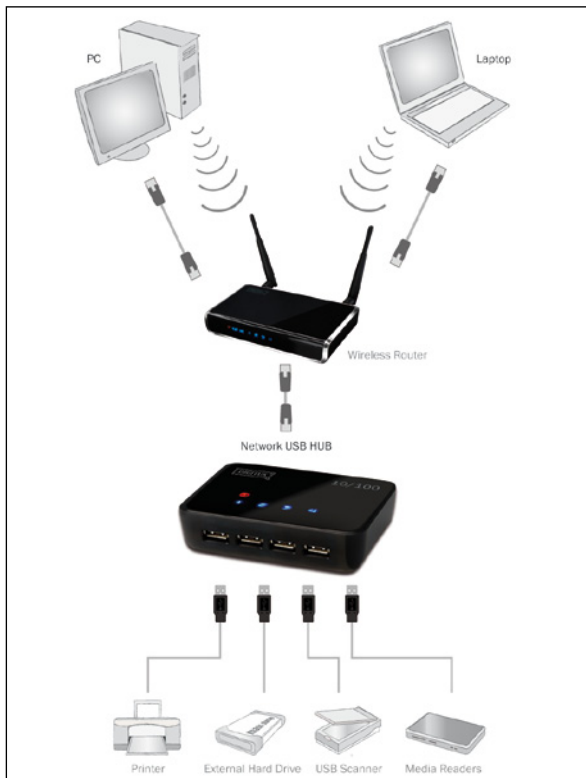

287896 / DN-13009-1
Fast Ethernet network USB hub

276593 / DN-13010
Gigabit network USB hub

DIGITUS® 1-Port USB 2.0 Multifunction Network Server

The all-in-one Solution: Integrated Print Server, NAS and Network USB Hub

Print Server - ideal for multifunction Printers

- NAS - connect your storage drives and turn it into a Network Attached Storage. Access your data over the network and internet. Wherever you want!
- Network USB Hub - connect and use USB devices over the network. No more cable hassle for Mobile Users!
- Supports all kind of printers, scanners, DVD drives, storages, cameras, webcams, digital TV tuners, iPods, iPads, iPhones and many more...
- Offers FTP, SMB and CIFS Server
- Provides 1 USB 2.0 Port, extension by USB Hub supported
- LAN: 10/100Mbps
- Supports Windows 7, Vista, XP and Mac OS X
- Easy setup through web browser

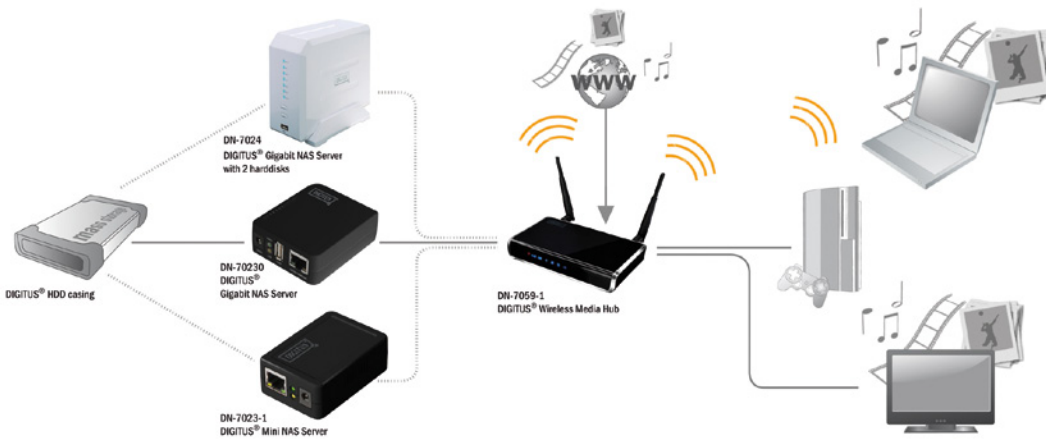

- 292913 / DN-13020**
1-Port USB 2.0 Multifunction Network Server
- 292920 / DN-13021**
1-Port USB 2.0 Wireless Multifunction Network Server
- 292937 / DN-13022**
4-Port USB 2.0 Multifunction Network Server
- 292944 / DN-13023**
4-Port USB 2.0 Wireless Multifunction Network Server



DIGITUS® Fast Ethernet print server, parallel

Easily turns a workplace printer into a network printer for all connected users

Complies with IEEE 802.3, IEEE 802.3u Wired Ethernet standards

- One parallel port suitable for printer connections
- Supports TCP/IP, IPX/SPX, NetBEUI, and AppleTalk network protocols
- Supports LPR, IPP, SMB/TCP, Raw Printing, and Unix Logical printing protocols
- Supports peer-to-peer printing (TCP/IP/IPX/NetBEUI/AppleTalk)
- Supports server based printing (Novell NetWare and Windows)
- Compatible with all major operating systems: Windows 98 / ME / NT / 2000 / XP / Vista / NetWare 3.x and higher / Unix / Linux
- Supports DHCP server and client protocols
- Supports web based management, Windows configuration utility, and SNMP protocol
- Offers a simple installation procedure, setup programs, and diagnostic programs
- Incl. power supply



209782 / DN-13001-W

Fast Ethernet print server, parallel

DIGITUS® Fast Ethernet print server, USB 2.0

Easily turns a workplace printer into a network printer for all connected users

Complies with IEEE 802.3, IEEE 802.3u Wired Ethernet standards

- One USB 2.0 port suitable for printer connections
- Supports TCP/IP, IPX/SPX, NetBEUI, and AppleTalk network protocols
- Supports LPR, IPP, SMB/TCP, Raw Printing, and Unix Logical printing protocols
- Supports peer-to-peer printing (TCP/IP/IPX/NetBEUI/AppleTalk)
- Supports server based printing (Novell NetWare and Windows)
- Compatible with all major operating systems: Windows 98 / ME / NT / 2000 / XP / Vista / NetWare 3.x and higher / Unix / Linux
- Supports DHCP server and client protocols
- Supports web based management, Windows configuration utility, and SNMP protocol
- Offers a simple installation procedure, setup programs, and diagnostic programs
- Incl. power supply



221913 / DN-13003-W

Fast Ethernet print server, USB 2.0

278016 / DN-13014-2

Wireless LAN print server with USB 2.0 interface

DIGITUS® 3-Port Fast Ethernet Print Server

Easily turns a workplace printer into a network printer for all connected users

Complies with IEEE 802.3, IEEE 802.3u Wired Ethernet standards

- Offers two USB 2.0 ports and one parallel port suitable for printer connections
- Supports TCP/IP, IPX/SPX, NetBEUI, Rendezvous, AppleTalk, and IPv6 network protocols
- Supports LPR, IPP, SMB/TCP, Raw Printing, and Unix Logical printing protocols
- Supports peer-to-peer printing (TCP/IP/IPX/NetBEUI/AppleTalk)
- Supports server based printing (Novell NetWare and Windows)
- Compatible with all major operating systems: Windows 98 / ME / NT / 2000 / XP / Vista / NetWare 3.x and higher / Unix / Linux
- Supports DHCP server and client protocols
- Supports web based management and the Windows configuration utility
- Offers a simple installation procedure, setup programs, and diagnostic programs
- Incl. power supply



221883 / DN-13006-W

Fast Ethernet print server, 2-port USB, 1-port parallel

DIGITUS® NAS, 2-port SATA HDD enclosure

Easy share, exchange and access files over the network
- also suitable as a Backup solution, Mediaserver or filesharing on the internet

This powerful Network Attached Storage System allows comfortable access to your data. With Gigabit connection nothing obstructs a passage at lightning speed. Offer all your multimedia matters in your network. Transferring your data to NAS couldn't be easier. Via USB-Connection you copy by push of a button. So a backup of your personal and commercial data becomes a child's play.

- Two drawer drive bays designed to easily customize for various storage needs
- Built-in FTP and Samba server
- Gigabit Ethernet
- Supports CIFS, FAT32, EXT2, EXT3 file systems
- Provides USB mass storage sharing function
- Share files via FTP or Network Neighborhood
- FTP/HTTP download agent
- Supports P2P download (Bit Torrent)
- Supports Media Server
- Supports iTunes Server
- Supports USB disk Auto-Copy function
- Web Configuration



243250 / DN-7024

NAS for 2 SATA HDDs, 2 USB mass storage devices

DIGITUS® Mini NAS server for external USB HDD

The compact and energy efficient NAS Server for sharing your files on the network!

The mini NAS Server enables USB 2.0 HDDs to access the network

- NAS function (Network Attached Storage) to provide centralized data access and storage to the network
- Easy provides storage space for expansion, sharing and backup to the whole network
- RJ45 network connector for Fast Ethernet 10/100 Mbps
- Samba and FTP Server for easy file access
- BitTorrent Server for automatic downloads, even when the computer is switched off
- Easy access of photos, movies or music over iTunes, Xbox 360 and Playstation 3
- Supports Windows 7, Vista, XP, Mac OS X and Linux
- Energy consumption 2.5 Watt



272977 / DN-7023-1

NAS server for external USB HDD

DIGITUS® Gigabit NAS server for external USB HDD

The compact and energy efficient NAS Server for sharing your files on the network!

The Gigabit NAS Server enables USB 2.0 HDDs to access the network

- NAS function (Network Attached Storage) to provide centralized data access and storage to the network
- Easy provides storage space for expansion, sharing and backup to the whole network
- Two USB Ports for up to two external Hard Disk Drives
- RJ45 network connector for Gigabit Ethernet 10/100/1000 Mbps
- Easy data backup between the connected HDDs by push button
- Samba and FTP Server for easy file access
- BitTorrent Server for automatic downloads, even when the computer is switched off
- Easy access of photos, movies or music over iTunes, Xbox 360 and Playstation 3
- Supports FAT 32 file system with up to 127 GB file size
- Supports Windows 7, Vista, XP, Mac OS X and Linux



308362 / DN-70230

Gigabit NAS Server für externe USB Festplatten

DIGITUS® Internet IP Camera

Highly sensitive motion detection

Video recording and image capturing via LAN network and internet

- Advanced motion detection - record and save events via Email/FTP-Server
- Integrated webservice supports standalone operation with direct internet connection
- Supported Protocols: DDNS, PPPoE, DHCP, NTP, ICMP, SMTP, HTTP, RTP, RTSP, ICMP, SNTP, TCP/IP, FTP
- Resolution up to 640 x 480 pixel
- 1/4" CMOS high quality image sensor
- Lens with F2,8 and 60 deg. viewing angle
- Automatic exposure and white balance
- MJPEG image compression, 3x digital Zoom
- 1x RJ45 10/100 Mbps network connector
- Easy mounting due to the included accessories
- Suitable for the most common browsers
- Powerful Windows Software included



291367 / DN-16024

Internet IP Camera

291374 / DN-16025

Internet Wireless IP Camera

DIGITUS® Internet Wireless IP Camera

Day and night home security without any cable clutter

The most complete, full featured and all-in-one network camera system. Ideal for all purpose of remote surveillance and security applications.

- Video recording and image capturing via LAN network and internet
- IR LED illumination for night vision and low light capability
- High sensitivity microphone for audio transmission
- Loudspeaker output for two-way communication
- Wireless LAN according to the newest 11n Standard for fluent image transmission
- Convenient installation to the wireless network due to the WPS function.
(The Wireless Access Point needs to support this feature)
- Meets the highest security requirements (WPA2 Encryption)
- Advanced motion detection - record and save events via Email/FTP-Server
- Integrated webservice supports standalone operation with direct internet connection
- Supported Protocols: DDNS, PPPoE, DHCP, NTP, ICMP, SMTP, HTTP, RTP, RTSP, ICMP, SNTP, TCP/IP, FTP
- Resolution up to 640 x 480 pixel
- 1/4" CMOS high quality image sensor
- Lens with F2,8 and 60 deg. viewing angle
- Automatic exposure and white balance
- MJPEG image compression, 3x digital Zoom
- 1x RJ45 10/100 Mbps network connector
- Detachable Antenna
- Easy mounting due to the included accessories
- Suitable for the most common browsers
- Powerful Windows Software included



291374 / DN-16025

Internet Wireless IP Camera

DIGITUS® Internet Pan & Tilt IP Camera

Advanced vision network camera for perfect home security

Video recording and image capturing via LAN network and internet

- Motorized pan and tilt function
- High sensitivity microphone for audio transmission
- Loudspeaker output for two-way communication
- Advanced motion detection - record and save events via Email/FTP-Server
- Integrated webserver supports standalone operation with direct internet connection
- Supported Protocols: DDNS, PPPoE, DHCP, NTP, ICMP, SMTP, HTTP, RTP, RTSP, ICMP, SNTP, TCP/IP, FTP
- Resolution up to 640 x 480 pixel
- 1/4" CMOS high quality image sensor
- Lens with F1,8 and 64 deg. viewing angle
- Automatic exposure and white balance
- Horizontal left / right pan +/-165 deg.
- Vertical up / down tilt +90 / -15 deg.
- MJPEG image compression, 3x digital Zoom
- 1x RJ45 10/100 Mbps network connector
- Easy mounting due to the included accessories
- Suitable for the most common browsers
- Powerful Windows Software included



291381 / DN-16033

Internet Pan & Tilt IP Camera

291398 / DN-16034

Internet Pan & Tilt Wireless IP Camera

DIGITUS® Internet Pan & Tilt Wireless IP Camera

Advanced vision wireless network camera for perfect home security at day & night

The most complete, full featured and all-in-one network camera system with motorized pan & tilt function. Ideal for all purpose of remote surveillance and security applications.

- Video recording and image capturing via LAN network and internet
- Motorized pan and tilt function
- IR LED illumination for night vision and low light capability
- High sensitivity microphone for audio transmission
- Loudspeaker output for two-way communication
- Wireless LAN according to the newest 11n Standard for fluent image transmission
- Convenient installation to the wireless network due to the WPS function. (The Wireless Access Point needs to support this feature)
- Meets the highest security requirements (WPA2 Encryption)
- Advanced motion detection - record and save events via Email/FTP-Server
- Integrated webserver supports standalone operation with direct internet connection
- Supported Protocols: DDNS, PPPoE, DHCP, NTP, ICMP, SMTP, HTTP, RTP, RTSP, ICMP, SNTP, TCP/IP, FTP
- Resolution up to 640 x 480 pixel
- 1/4" CMOS high quality image sensor
- Lens with F1,8 and 64 deg. viewing angle
- Automatic exposure and white balance
- Horizontal left / right pan +/-165 deg.
- Vertical up / down tilt +90 / -15 deg.
- MJPEG image compression, 3x digital Zoom
- 1x RJ45 10/100 Mbps network connector
- Detachable Antenna
- Easy mounting due to the included accessories
- Suitable for the most common browsers
- Powerful Windows Software included



291398 / DN-16034

Internet Pan & Tilt Wireless IP Camera

DIGITUS® Internet Wireless 11n HD IP Camera

Wireless home security without any cable clutter

The most complete, full featured all-in-one network camera system. Ideal for all purposes of remote surveillance and suitable for security applications.

- Crystal clear HD Video Resolution (SXVGA 1280x960, VGA 640x480, QVGA 320x240)
- Powerful mobile surveillance supporting iOS and Android devices
- Low-latency video streaming for sharp and clear images
- Wireless LAN according to the newest 11n Standard for fluent image transmission
- Convenient installation to the wireless network due to the WPS function. (The Wireless Access Point needs to support this feature)
- Meets the highest security requirements (WPA2 Encryption)
- Advanced motion detection - record and save events via Email/FTP-Server
- Integrated webserver supports standalone operation with direct internet connection
- High quality Megapixel CMOS sensor
- MJPEG image compression, 4x digital Zoom
- Supports up to 30 fps Video Frame Rate at QVGA and VGA, 10-15 fps at HD Resolution
- LAN Speed: 10/100Base-TX Ethernet
- Easy mounting due to the included accessories
- Suitable for the most common browsers
- Powerful Windows Software included
- Operating Temperature: 0°C - 40°C
- Power Source (±10%): DC5V / 1.0A
- Dimensions (mm): 27(L) x 65(W) x 80(H)



310785 / DN-16026

Internet Wireless 11n HD IP Camera

DIGITUS® Internet Pan & Tilt Wireless HD IP Camera

Advanced vision network camera for perfect home security

The most complete, full featured all-in-one network camera system with motorized pan and tilt functions. Ideal for all purposes of remote surveillance and suitable for security applications.

- Crystal clear HD Video Resolution (SXGA 1280x1024, VGA 640x480, QVGA 320x240)
- Video recording and image capturing via LAN network and internet
- Motorized pan and tilt functions, controllable by network devices
- High sensitivity microphone for audio transmission
- Loudspeaker output for two-way communication
- Powerful mobile surveillance supporting iOS and Android devices
- Low-latency video streaming for sharp and clear images
- Supports H.264, MPEG4 and MJPEG Compressions
- Wireless LAN according to the newest 11n Standard for fluent image transmission
- Convenient installation to the wireless network due to the WPS function. (The Wireless Access Point needs to support this feature)
- Meets the highest security requirements (WPA2 Encryption)
- 2 detachable antennas with RP-SMA connector
- Supports SD Cards with up to 8GB Space
- Advanced motion detection - record and save events via Email/FTP-Server
- Integrated webserver supports standalone operation with direct internet connection
- High quality 1.3 Megapixel CMOS sensor
- 5mm Lens with F2.8
- Supports up to 30 fps Video Frame Rate at QVGA and VGA, 10-15 fps at HD Resolution
- LAN Speed: 10/100Base-TX Ethernet
- Easy mounting due to the included accessories
- Suitable for the most common browsers
- Powerful Windows Software included
- Horizontal pan up to 355°
- Vertical tilt up to 120°
- Operating Temperature: 0°C - 40°C
- Power Source (±10%): DC12V / 1A
- Dimensions (mm): 108 x 112 x 108
- Connectable with DN-70105 for higher range



311119 / DN-16035

Internet Pan & Tilt Wireless HD IP Camera

DIGITUS® Advanced Network Camera



Suits your surveillance needs at day and night

Feeling safe is priceless. For this reason you should never compromise on security. Do we not have enough worries these days? Hand a part over: This camera is ideal for reliable indoor monitoring. The robust design raises no doubts that this might be a toy. The H.264 video standard ensures smooth, crystal clear images at a lower network load compared to legacy technologies. Thanks to infrared lighting the high resolution offers details even at night. Equipped with 2-way audio system the camera can also be deployed for hands-free intercom operation. Not only the hardware is convincing: With auto motion detection and supplied software your equipment is future-proof and you save a lot of time! Just focus on the essential instead of painstakingly going through the daily recordings! Video images are only generated in case of activity.

- True Day and Night surveillance
- Large aperture lens (F1.9)
- Prime lens: f4.6mm
- Viewing Angle: 60°
- High resolution and best video performance
- Enhanced motion detection and alarm notification functions
- Alarm and event notification by FTP and Email
- Powerful mobile surveillance supporting iPhone, Blackberry and WinCE devices
- Wireless LAN function with the usage of a wireless LAN USB Stick with Ralink Chipset (e.g. the DIGITUS Antenna adapter DN-7044)
- Low-latency video streaming with H.264 compression format
- Hybrid digital / analog video output
- Built-in microphone & external microphone input
- External audio output
- External alarm input
- LAN Speed: 10/100Base-TX Ethernet
- Supported Protocols: DDNS, PPPoE, DHCP, NTP, SNTP, TCP/IP, ICMP, SMTP, FTP, HTTP, RTP, RTSP
- Frame Rate NTSC: 30, PAL: 25
- Number of Online Users: 10
- Security: Multiple user access levels with password protection
- Management by web browser or CMS software for up to 16 network cameras control simultaneously
- Compatible to the future proof ONVIF Standard
- Image Sensor: 1/3" HR color CCD sensor
- Resolution: 768x494 pixel NTSC / 752x582 pixel PAL
- Min Illumination 0 Lux (IR ON)
- Shutter Speed 1/60 (1/50) to 1/100,000 sec.



- IR effective distance up to 10 meters
- Operating Temperature: 0°C - 40°C
- Power Source (±10%): DC12V / 1A
- Dimensions (mm): 152.5(L) x 115.2(W) x 40.2(H)



292821 / DN-16061-1
Advanced Network Camera

DIGITUS® HD Network Camera



High Resolution - For a crisp view of the smallest details

Feeling safe is priceless. For this reason you should never compromise on security. Do we not have enough worries these days? Hand a part over: This camera is ideal for reliable indoor monitoring. The H.264 video standard ensures smooth, crystal clear images at a lower network load compared to legacy technologies. Thanks to infrared lighting in the dark the camera automatically switches to night mode. The megapixel sensor is inspiring: superior image quality and highest definition show even the tiniest detail. Not only the hardware is convincing: With auto motion detection and supplied software your equipment is future-proof and you save a lot of time! Just focus on the essential instead of painstakingly going through the daily recordings! Video images are only generated in case of activity. Even automatic face recognition is possible!

- True Day and Night surveillance
- Large aperture lens (F1.5)
- Prime lens: f4.0mm
- Viewing Angle: 75°
- High resolution and best video performance
- Future Proof - Compatible to all ONVIF devices
- Enhanced motion detection and alarm notification functions
- Alarm and event notification by FTP and Email
- Powerful mobile surveillance supporting iPhone, Blackberry and WinCE devices
- Low-latency video streaming with H.264 compression format
- LAN Speed: 10/100Base-TX Ethernet
- Supported Protocols: DDNS, PPPoE, DHCP, NTP, SNTP, TCP/IP, ICMP, SMTP, FTP, HTTP, RTP, RTSP
- Frame Rate NTSC: 30, PAL: 25
- Number of Online Users: 10
- Security: Multiple user access levels with password protection
- Management by web browser (Support for all common browser, like Firefox, Safari, Chrome, Internet Explorer) or CMS software (Supports Windows 7, Vista, XP) for up to 16 network cameras control simultaneously
- Image Sensor: 1/3" 1.3 Megapixel HR color MOS sensor
- Resolution: 1024x768 pixel NTSC / PAL
- Min Illumination 0.1 Lux / F1.5, 0 Lux (LED ON)
- Shutter Speed 1/60 (1/50) to 1/100,000 sec.
- Effective Night View distance up to 10 meters with white LED
- Operating Temperature: 0°C - 40°C
- Power Source (±10%): DC5V / 1.2A
- Dimensions (mm): 41(L) x 59(W) x 95.4(H)



292753 / DN-16062
HD Network Surveillance Camera

DIGITUS® Camera Mounting Bracket, 120mm



DIGITUS® original accessory

Bracket for Indoor mount

- 6,4mm (1/4") Tripod screw
- 360° Swivel Joint
- Material: Aluminum
- Maximum loading capacity: 2kg
- Weight: 0.09kg



287544 / DN-16090

Kamerahalterung, 120mm

DIGITUS® Camera Mounting Bracket, 242x204mm



DIGITUS® original accessory

Bracket for Indoor mount

- 6,4mm (1/4") Tripod screw
- 360° Swivel Joint
- Integrated cable duct
- Material: Aluminum
- Maximum loading capacity: 4kg
- Weight: 0.47kg



287568 / DN-16092

Camera Mounting Bracket, 242x204mm

DIGITUS® Camera Mounting Bracket, 130mm

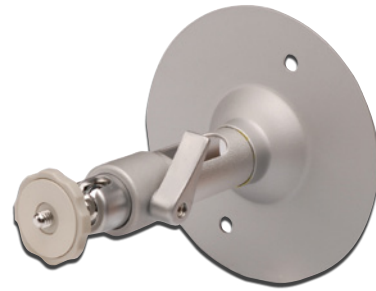

DIGITUS® original accessory

Bracket for Indoor mount

- 6,4mm (1/4") Tripod screw
- 360° Swivel Joint
- Integrated cable duct
- Material: Aluminum
- Maximum loading capacity: 4kg
- Weight: 0.33kg



287551 / DN-16091

Camera Mounting Bracket, 130mm

DIGITUS® Camera Mounting Bracket, 305-465mm



DIGITUS® original accessory

Bracket for Indoor mount

- Sliding from 305 up to 465mm
- 6,4mm (1/4") Tripod screw
- 360° Swivel Joint
- Integrated cable duct
- Material: Aluminum
- Maximum loading capacity: 4kg
- Weight: 0.56kg



287575 / DN-16093

Camera Mounting Bracket, 305-465mm

DIGITUS® Passive PoE cable kit



Simplifies your Ethernet-enabled device installations by combining power and data onto one cable

- 1x Incoming cable, featuring RJ45 plug, DC jack and RJ45 jack
- 1x Outgoing cable for the device, featuring RJ45 plug, DC plug and RJ45 jack
- Suitable for 5.5mm DC plugs
- Connection speed: 10/100 Mbit/s
- PVC coating
- RJ45 plug
- Assignment: 1/2/3/6 for data transfer, 4/5/7/8 for power supply



260240 / DN-95001
Passive PoE cable kit

DIGITUS® PoE Injector, 802.3af



Reduce cabling for Wireless APs, IP Phone and any PoE-ready device

- Complies with the 802.3af PoE standard
- 48V output voltage, 15.4 Watt
- LAN(RJ45) input jack
- LAN(RJ45) output jack
- Connection: 10/100 Mbit/s
- Each output port has output current limited, short-circuit protection, complete Powered Device (PD) detection and classification



279303 / DN-95102
PoE Injector, 802.3af

DIGITUS® 8-Port Fast Ethernet Switch with 4 PoE Ports



Integrated Power over Ethernet (PoE) for small and medium network environments

- 8-Port 10/100BaseTX with 4-Port PoE
- PoE Power Output 48V/DC, max. 15.4W per Port
- Maximum Power Consumption 65 Watts
- Supported Standards: IEEE 802.3x Flow Control, IEEE 802.3af Power over Ethernet (PoE)
- Store and Forward technology
- Inclusive Mounting Accessories for Rack Installation



291947 / DN-95321
8-Port Fast Ethernet Switch with 4 PoE Ports

DIGITUS® PoE Splitter, 802.3af



Integrates Power over Ethernet technology to legacy network devices

- Complies with the 802.3af PoE standard
- PoE(RJ45) input jack
- Selectable output voltages: 5V 2A, 7.5V 1.4A, 9V 1.2A and 12V 0.9A
- LAN(RJ45) output jack
- DC output jack, 2.5mm (plug / plug cable included in delivery)
- Connection: 10/100 Mbit/s



279396 / DN-95202
PoE Splitter, 802.3af

DIGITUS® Premium CAT 5e patch cables

- 4 x 2 AWG 26/7, twisted pair, 100 Ohm
- 2 x RJ45 connectors
- Boot with kink protection and strain relief
- Spot length on boot
- Connection 1:1
- Qualified for 1 Gbit Ethernet
- Ready for PoE

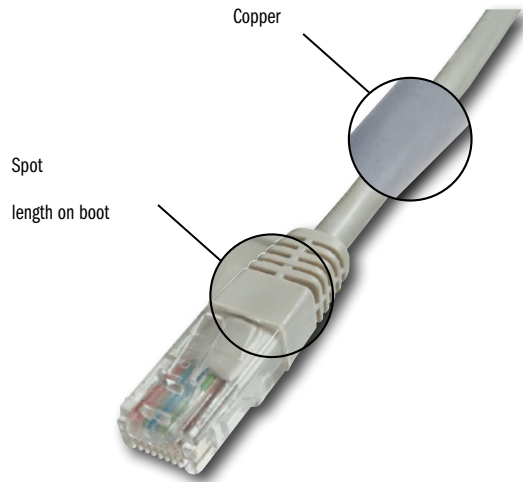

Ready for
PoE



CAT 5e U-UTP, unshielded

	grey	red	yellow	green	blue	black	white
0,25 m	DK-1511-0025	DK-1511-0025/R	DK-1511-0025/Y	DK-1511-0025/G	DK-1511-0025/B	DK-1511-0025/BL	DK-1511-0025/WH
0,5 m	DK-1511-005	DK-1511-005/R	DK-1511-005/Y	DK-1511-005/G	DK-1511-005/B	DK-1511-005/BLACK	DK-1511-005/WH
1,0 m	DK-1511-010	DK-1511-010/R	DK-1511-010/Y	DK-1511-010/G	DK-1511-010/B	DK-1511-010/BLACK	DK-1511-010/WH
1,5 m	DK-1511-015	DK-1511-015/R	DK-1511-015/Y	DK-1511-015/G	DK-1511-015/B	DK-1511-015/BLACK	DK-1511-015/WH
2,0 m	DK-1511-020	DK-1511-020/R	DK-1511-020/Y	DK-1511-020/G	DK-1511-020/B	DK-1511-020/BLACK	DK-1511-020/WH
3,0 m	DK-1511-030	DK-1511-030/R	DK-1511-030/Y	DK-1511-030/G	DK-1511-030/B	DK-1511-030/BLACK	DK-1511-030/WH
5,0 m	DK-1511-050	DK-1511-050/R	DK-1511-050/Y	DK-1511-050/G	DK-1511-050/B	DK-1511-050/BLACK	DK-1511-050/WH
7,0 m	DK-1511-070	DK-1511-070/R	DK-1511-070/Y	DK-1511-070/G	DK-1511-070/B	DK-1511-070/BLACK	DK-1511-070/WH
10,0 m	DK-1511-100	DK-1511-100/R	DK-1511-100/Y	DK-1511-100/G	DK-1511-100/B	DK-1511-100/BLACK	DK-1511-100/WH
15,0 m	DK-1511-150	DK-1511-150/R	DK-1511-150/Y	DK-1511-150/G	DK-1511-150/B	DK-1511-150/BLACK	DK-1511-150/WH
20,0 m	DK-1511-200	DK-1511-200/R	DK-1511-200/Y	DK-1511-200/G	DK-1511-200/B	DK-1511-200/BLACK	DK-1511-200/WH
25,0 m	DK-1511-250						
30,0 m	DK-1511-300	DK-1511-300/R	DK-1511-300/Y	DK-1511-300/G	DK-1511-300/B	DK-1511-300/BLACK	DK-1511-300/WH

CAT 5e F-UTP, foil shielded

	grey	red	yellow	green	blue	black	white	crossover
0,25 m	DK-1521-0025	DK-1521-0025/R	DK-1521-0025/Y	DK-1521-0025/G	DK-1521-0025/B	DK-1521-0025/BL	DK-1521-0025/WH	
0,3 m								DK-1521-003-CO
0,5 m	DK-1521-005	DK-1521-005/R	DK-1521-005/Y	DK-1521-005/G	DK-1521-005/B	DK-1521-005/BL		DK-1521-005-CO
1,0 m	DK-1521-010	DK-1521-010/R	DK-1521-010/Y	DK-1521-010/G	DK-1521-010/B	DK-1521-010/BL		DK-1521-010-CO
2,0 m	DK-1521-020	DK-1521-020/R	DK-1521-020/Y	DK-1521-020/G	DK-1521-020/B	DK-1521-020/BL		DK-1521-020-CO
3,0 m	DK-1521-030	DK-1521-030/R	DK-1521-030/Y	DK-1521-030/G	DK-1521-030/B	DK-1521-030/BL		DK-1521-030-CO
5,0 m	DK-1521-050	DK-1521-050/R	DK-1521-050/Y	DK-1521-050/G	DK-1521-050/B	DK-1521-050/BL		DK-1521-050-CO
7,0 m	DK-1521-070							
10,0 m	DK-1521-100	DK-1521-100/R	DK-1521-100/Y	DK-1521-100/G	DK-1521-100/B	DK-1521-100/BL		DK-1521-100-CO
15,0 m	DK-1521-150	DK-1521-150/R	DK-1521-150/Y	DK-1521-150/G	DK-1521-150/B	DK-1521-150/BL		DK-1521-150-CO
20,0 m	DK-1521-200	DK-1521-200/R	DK-1521-200/Y	DK-1521-200/G	DK-1521-200/B	DK-1521-200/BL		DK-1521-200-CO
30,0 m	DK-1521-300							DK-1521-300-CO
50,0 m	DK-1521-500							

CAT 5e SF-UTP, foil and braid shielded

	grau	rot	gelb	grün	blau	schwarz	weiß	crossover
0,25 m	DK-1531-0025	DK-1531-0025/R	DK-1531-0025/Y	DK-1531-0025/G	DK-1531-0025/B	DK-1531-0025/BL	DK-1531-0025/WH	
0,5 m	DK-1531-005	DK-1531-005/R	DK-1531-005/Y	DK-1531-005/G	DK-1531-005/B	DK-1531-005/BL		DK-1531-005-CO
1,0 m	DK-1531-010	DK-1531-010/R	DK-1531-010/Y	DK-1531-010/G	DK-1531-010/B	DK-1531-010/BL		DK-1531-010-CO
2,0 m	DK-1531-020	DK-1531-020/R	DK-1531-020/Y	DK-1531-020/G	DK-1531-020/B	DK-1531-020/BL		DK-1531-020-CO
3,0 m	DK-1531-030	DK-1531-030/R	DK-1531-030/Y	DK-1531-030/G	DK-1531-030/B	DK-1531-030/BL		DK-1531-030-CO
5,0 m	DK-1531-050	DK-1531-050/R	DK-1531-050/Y	DK-1531-050/G	DK-1531-050/B	DK-1531-050/BL		DK-1531-050-CO
7,0 m	DK-1531-070	DK-1531-070/R	DK-1531-070/Y	DK-1531-070/G	DK-1531-070/B	DK-1531-070/BL		
10,0 m	DK-1531-100	DK-1531-100/R	DK-1531-100/Y	DK-1531-100/G	DK-1531-100/B	DK-1531-100/BL		DK-1531-100-CO
15,0 m	DK-1531-150	DK-1531-150/R	DK-1531-150/Y	DK-1531-150/G	DK-1531-150/B	DK-1531-150/BL		DK-1531-150-CO
20,0 m	DK-1531-200	DK-1531-200/R	DK-1531-200/Y	DK-1531-200/G	DK-1531-200/B	DK-1531-200/BL		DK-1531-200-CO
30,0 m	DK-1531-300	DK-1531-300/R	DK-1531-300/Y	DK-1531-300/G	DK-1531-300/B	DK-1531-300/BL		DK-1531-300-CO

DIGITUS® Premium CAT 5e unshielded flat patch cable

- Unshielded CAT 5e patch cable
- Spot length on boot
- Boot with strain relief
- Connection 1:1

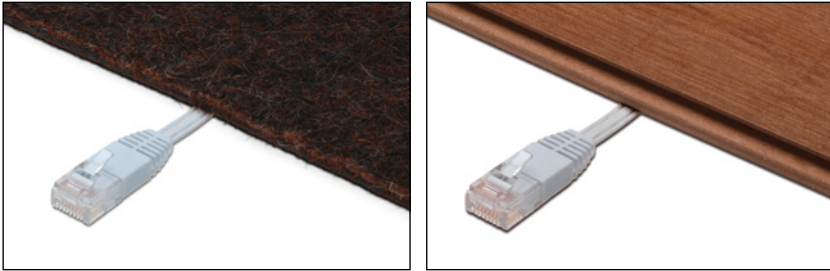

The premium flat patch cable is perfect to lay under laminate, carpets or behind skirting boards



	yellow	green	black	white
0.5m	DK-1511-005F/Y	DK-1511-005F/G	DK-1511-005F/BL	DK-1511-005F/WH
1.0m	DK-1511-010F/Y	DK-1511-010F/G	DK-1511-010F/BL	DK-1511-010F/WH
2.0m	DK-1511-020F/Y	DK-1511-020F/G	DK-1511-020F/BL	DK-1511-020F/WH
3.0m	DK-1511-030F/Y	DK-1511-030F/G	DK-1511-030F/BL	DK-1511-030F/WH
5.0m	DK-1511-050F/Y	DK-1511-050F/G	DK-1511-050F/BL	DK-1511-050F/WH
7.5m	DK-1511-075F/Y	DK-1511-075F/G	DK-1511-075F/BL	DK-1511-075F/WH



DIGITUS® CAT 5e F-UTP twisted pair installation cable

Best performance and link quality for your network

4 x 2 x AWG24 F-UTP CAT5e 100MHz, installation cable

Suitable for building structured cabling in the secondary and tertiary area.
 Suitable for installations of class D cable lines, 100MHz.
 Conforming to ISO/IEC 11801, DIN EN 50173, DIN EN 50288-2-1

- Basic conductor: solid AWG 24/1
- Insulation: PE
- Total number of insulated conductors: 8, twisted in 4 pairs
- Color code: blue-white, orange-white, green-white, brown-white
- Individual pair shielding: none
- Overall shielding: aluminum foil
- Outer jacket: PVC
- Color: gray
- Mean impedance: 100±50hm at 100MHz
- Capacitance unbalance to ground: 1600pF/100m min.
- Insulation resistance: 0.5G0hm*Km min.
- DC loop resistance: 190hm/100m max. (2% max. resistance unbalance)

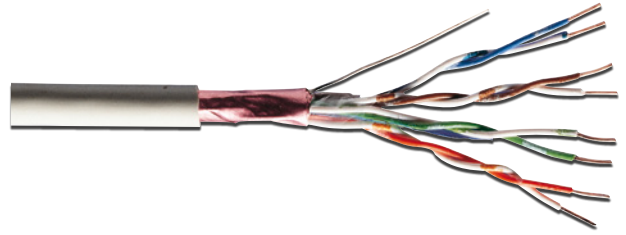

241119 / DK-1521-V-1

100m paper box, PVC outer jacket

241126 / DK-1521-V-305

305m paper box, PVC outer jacket

241133 / DK-1521-P-1

100m paper box, PVC outer jacket

DIGITUS® CAT 5e SF-UTP LSOH twisted pair installation cable

Best performance and link quality for your network

4 x 2 x AWG24 SF-UTP CAT5e 100MHz, installation cable

Suitable for building structured cabling in the secondary and tertiary area.
 Suitable for installations of class D cable lines, 100MHz.
 Conforming to ISO/IEC 11801, DIN EN 50173, DIN EN 50288-2-1

- Basic conductor: solid AWG 24/1
- Insulation: PE
- Total number of insulated conductors: 8, twisted in 4 pairs
- Color code: blue-white, orange-white, green-white, brown-white
- Individual pair shielding: none
- Overall shielding: aluminum foil and tin-coated copper wire braid
- Outer jacket: low-smoke, zero-halogen, flame retardant, non corrosive compound for indoor use
- Color: gray
- Mean impedance: 100±150hm at 1MHz - 250MHz
- Capacitance unbalance to ground: 1600pF/100m min.
- Insulation resistance: 0.5G0hm*Km min.
- DC loop resistance: 190hm/100m max. (2% max. resistance unbalance)

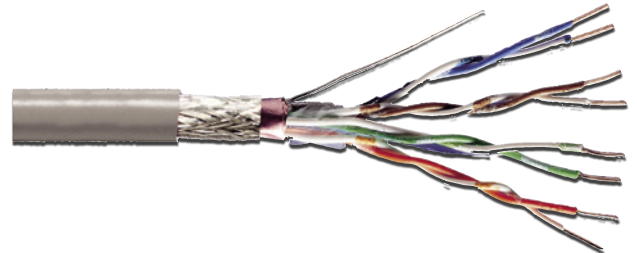

241201 / DK-1531-VH-1

100m paper box, halogenfree outer jacket

DIGITUS® CAT 6 F-UTP twisted pair installation cable

Best performance and link quality for your network

4 x 2 x AWG24 F-UTP CAT6 250MHz, twisted pair installation cable

Suitable for building structured cabling in the secondary and tertiary area.
 Class E CAT 6, up to 250 MHz, ISO IEC 11801, EN 50173
 Conforming to ISO/IEC 11801, DIN EN 50173, DIN EN 50288-2-1

- Basic conductor: solid AWG 24/1
- Insulation: PE
- Total number of insulated conductors: 8, twisted in 4 pairs
- Color code: blue-white, orange-white, green-white, brown-white
- Individual pair shield: none
- Overall shielding: aluminum foil
- Outer jacket: halogenfree (LSZH)
- Color: orange (RAL 2000)
- Mean impedance: 100±50hm at 100MHz
- Capacitance unbalance to ground: 1.6 pF/m max. at 1KHz
- Insulation resistance: 0.5G 0hm/km min.
- DC loop resistance: 19 0hm/100m max. (2% max. resistance unbalance)

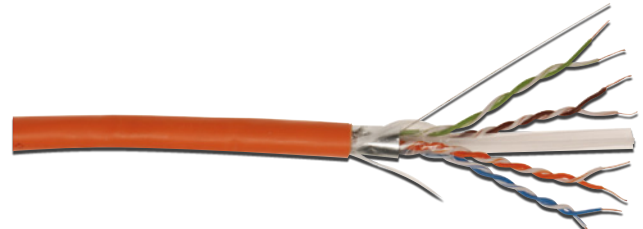

256205 / DK-1621-VH-1

100m drum, halogenfree outer jacket

DIGITUS® CAT 5e wall outlet, flush mount

Full compatible design

Applicable for horizontal cabling systems acc. ISO/IEC 11801.2 Class Link-D

- CAT 5e, EIA TIA 568 and ISO IEC 11801 / EN 50173
- Suitable for up to 100MHz
- Complete shielding of RJ45 sockets and LSA strips from enclosed metal die cast housing
- Integrated installation cable strain relief
- 40° socket angle
- Trunking system, surface / flush mount possible
- Cable installation via LSA strips, color coded according to EIA/TIA 568 A & B
- Frame 80x80mm incl. central plate 50x50mm according to DIN 49075
- Horizontal cable entry
- Color RAL 9010



175650 / DN-9001-N

CAT 5e outlet, flush mount

175704 / DN-9001/B5-N

CAT 5e Outlet, Flush mount, 5 pcs.

DIGITUS® CAT 6 wall outlet, flush mount

Full compatible design

Tested for Link Performance Class E, for up to 250MHz, EN 50173 and ISO/IEC 11801

- CAT 6, EIA/TIA 568 und ISO/IEC 11801 / EN 50173
- Suitable for up to 250MHz
- Complete shielding of RJ45 sockets and LSA strips from enclosed metal die cast housing
- Integrated installation cable strain relief
- 40° socket angle
- Trunking system, surface / flush mount ready
- Cable installation via LSA strips, color codes based on EIA/TIA 568 A & B
- Frame 80x80mm incl. central plate 50x50mm according to DIN 49075
- Horizontal cable entry
- Color RAL 9010



175711 / DN-9005-N

CAT 6 Outlet, flush mount

175759 / DN-9005/B5-N

CAT 6 Outlet, Flush mount, 5 pcs.

DIGITUS® CAT 5e Wall Outlets shielded, surface mount

CAT 5e, EIA TIA 568 and ISO IEC 11801 / EN 50173

- Suitable up to 100MHz
- Complete shielding of RJ45 sockets and LSA strips from enclosed metal die cast housing
- Integrated installation cable strain relief
- 40° socket angle
- On wall / in wall ready
- Cable installation via LSA strips, colour codes based on EIA/TIA 568 A & B



175681 / DN-9002-N

Cat5e Outlet, surface mount

175698 / DN-9002/B5-N

Cat5e Outlet, Surface mount, 5 pcs.

DIGITUS® Desktop CAT 5e patch panel, shielded



Applicable for SOHO solutions

Manufactured acc. Link Performance Class D, for up to 100MHz, EN 50173 and ISO/IEC 11801

- Class D, up to 100 MHz, ISO IEC 11801, EN 50173
- Material housing: SECC, 1,5mm ElectroGalvanized, Cold-rolled Steel accc. EN1.4301, UNS S30400, AISI 304 and LMSAD110
- Shielded RJ45 sockets, 8P8C
- Cable installation via LSA strips, color coded according to EIA/TIA 568 A & B
- Fixing option for cable ties
- Central ground connection
- Desktop version



108931 / DN-10001

8-port, shielded, Desktop version

DIGITUS® Network- and communication cable tester, RJ45 and BNC



Specifically designed for quick and easy testing of your network cables

Test function for cables with RJ45, RJ12, RJ11 and BNC plug

- Auto-scan and step by step testing
- Loop-back: for testing and localising of already laid network or communication cables
- Continuity: for continuity testing of network or communication cables
- Open: for localising of disconnected single wires
- Shorts: locating of short-circuited single wires
- Miss-wire: identification of non-conform wire assignment
- Pin to pin configuration: 1:1 assignment testing
- Main device with 2x RJ45 jack, remote unit with 1x RJ45 jack
- Various LEDs for status display, operates with 9 Volt block battery
- Includes two-language manual and modular BNC adapter



126454 / DN-14001

Cable tester, RJ-45 and BNC

DIGITUS® Desktop CAT 6 patch panel, shielded



Applicable for SOHO solutions

Manufactured acc. Link Performance Class E, for up to 250MHz, EN 50173 and ISO/IEC 11801

- Class E, up to 250 MHz, ISO IEC 11801, EN 50173
- 1 Gbit Ethernet
- Material housing: SECC, 1,5mm ElectroGalvanized, Cold-rolled Steel accc. EN1.4301, UNS S30400, AISI 304 and LMSAD110
- Shielded RJ45 sockets, 8P8C
- Cable installation via LSA strips, color coded according to EIA/TIA 568 A & B
- Fixing option for cable ties
- Central ground connection
- Desktop version



241584 / DN-91608SD

8-port, shielded, Desktop version

DIGITUS® Modular tool set in case



The DIGITUS Modular Tool Kit in a plastic suit case is the ideal solution for service technicians. This tool kit contains the most common tools for the modular cabling technology.

- Multi modular crimping tool
- Stripper
- Plastic case with compartments
- 20x8P8C plugs
- 20x6P6C plugs
- 40x4P4C plugs



254607 / DN-94010

Modular tool set

254591 / DN-94011

Network tool kit, arranged in plastic case

DIGITUS® Surface Mountbox 80/80mm



Surface mount frame for additional Key Stone Jack Wall Outlet.

- Compatible with DIGITUS Outlets, Keystone Faceplates 80x80mm
- Shining structured surface parts
- Color: White RAL 9010



259367 / DN-93803

Surface Mount Box for walloutlets 80x80mm

DIGITUS® LSA punch tool



Punch tool for LSA strips

- Cable insulation and cutting of the extending cable ends
- Includes synthetic leather carry case
- Includes Extraction- and Unlocking Device



206569 / DN-LSA-PT

LSA punch tool

DIGITUS® SoHo slim wall mount cabinet

The DIGITUS Slim Line wall mount cabinets are ideal housings for active and passive 483mm (19") components. The installation is easy and saves time. The elegant design fits into every modern office or home. Four mounting positions possible.

- 483mm (19") device mounting capacity for 5U: 3U horizontal and 2U vertical
- Lockable Safety-glass door with steel frame
- Strong sheet steel with high load capacity, powder coated
- Ventilation slots for active and passive ventilation and exhaustion
- Protection rating IP 20
- Color: light grey, RAL 7035
- Loading capacity: 80 Masse
- Units: 5
- Dimensions (HxWxD): 497 x 140 x 475 mm



200109 / DN-19 04U-PB

Wallmount cabinet

DIGITUS® SoHo PC cabinet

DIGITUS SoHo PC cabinets offer an excellent solution for workshops, factories, processes, warehouses and laboratories.

- 1.5mm strong sheet steel with high load capacity, powder coated
- Side sections detachable and lockable
- Ventilation slots for active and passive ventilation and exhaustion
- Framed and lockable safety glass front & steel door
- Delivered with castor group



200109 / DN-19 04U-PB

Wandgehäuse

200109 / DN-19 04U-PB

Wandgehäuse

DIGITUS® Wall mounting patch bracket

The DIGITUS Wall mounting patch brackets are economical solutions for the safe installation of 483mm (19") components. The depth of the mounting rails is adjustable, which offers variable mounting possibilities.

- 2mm strong sheet steel with high load capacity, powder coated
- 483mm (19") Profile rails adjustable in depth up to 350mm
- Hinged, rotatable
- Bracket width: 530mm
- Delivered in flat package
- Color: light grey, RAL 7035
- Units: 2



205982 / DN-19 PB-2U

Patch Bracket 2U, 530x350mm, Color grey RAL 7035

205999 / DN-19 PB-4U

Patch Bracket 4U, 530x350mm, Color grau RAL 7035

206002 / DN-19 PB-8U

Patch Bracket 8U, 530x350mm, Color grey RAL 7035

257325 / DN-19 PB-2U-SW

2U, 530x350mm, Color black RAL 9005

250371 / DN-19 PB-4U-SW

4U, 530x350mm, Color black RAL 9005

228806 / DN-19 PB-8U-SW

8HE, 530x350mm, Farbe schwarz RAL 9005

DIGITUS® Wall mounting cabinet

The DIGITUS wall mounting cabinets are made of a robust steel sheet construction with a minimum of seams. The side sections are detachable and lockable. It is fast and easy to mount the cabinet. Separately there are levelling feet or castors available. Due to their flexibility the cabinets are ideal for all current IT- and Telecommunication applications.

- 1.1 - 1.5mm strong sheet steel with high load capacity, powder coated
- Side sections detachable and lockable
- Ventilation slots for active and passive ventilation and exhaustion
- IP 40 rating
- Lockable Safety-glass door with steel frame
- 483mm (19") profile rails on the front side, adjustable in depth
- Cable entry on top and bottom
- Inclusive 8 pieces mounting set
- Extensive range of accessories available
- Color: lichtgrau, RAL 7035
- Units: 7
- Dimensions (HxWxD): 402 x 600 x 450 mm



135203 / DN-19 07-U

Wallmount cabinet 7U, 402x600x450mm

135210 / DN-19 09-U

Wallmount cabinet 9U, 491x600x450mm

135227 / DN-19 12-U

Wallmount cabinet 12U, 624x600x450mm

135234 / DN-19 16-U

Wallmount cabinet 16U, 802x600x450mm

205968 / DN-19 20-U

Wallmount cabinet 20U, 980x600x450mm

190103 / DN-19 07U-6/6

Wallmount cabinet 7U, 402x600x560mm

157519 / DN-19 09U-6/6

Wallmount cabinet 9U, 491x600x560mm

180517 / DN-19 12U-6/6

Wallmount cabinet 12U, 624x600x560mm

174097 / DN-19 16U-6/6

Wallmount cabinet 16U, 802x600x560mm

205975 / DN-19 20U-6/6

Wallmount cabinet 20U, 980x600x560mm

DIGITUS® SoHo wall mounting cabinet, unmounted

The completely unmounted DIGITUS wall cabinets save space and enormously save transport costs. They can easily and swiftly be mounted. The mounting angles are adjustable in depth. Due to this flexibility the wall mounting cabinets are ideal for all current IT and telecommunication applications.

- 1.1 - 1.5mm strong sheet steel with high load capacity, powder coated
- Ventilation slots for active and passive ventilation and exhaustion
- Lockable Safety-glass door with steel frame
- 483mm (19") profile rails on the front side, adjustable in depth
- Cable entry on top and bottom
- Inclusive 1 piece brush for cable entry
- Inclusive 8 pieces mounting set
- Extensive range of accessories available
- Color: light grey, RAL 7035
- Units: 7
- Dimensions (HxWxD): 360 x 520 x 400 mm



135241 / DN-19 07-U-S

Wallmount cabinet 7U, 360x520x400mm

135258 / DN-19 09-U-S

Wallmount cabinet 9U, 448x520x400mm

135432 / DN-19 12-U-S

Wallmount cabinet 12U, 581x520x400mm

Product comparison table - Pocket and Compact KVMs

	Consoles- / Working side				Supported PC connections					useable cables *	Specifics
	Monitor	Keyboard	Mouse	Sound	Anzahl PCs	Monitor	Keyboard	Mouse	Sound		
DS-16101	VGA	USB			2	VGA	USB			USB cable to connect 2 PCs	KM-Switch, switching by mouse moving possible
DC 0C12	VGA	PS/2	PS/2		2	VGA	PS/2	PS/2		Permanently integrated PC connection cables	
DC 0C12A	VGA	PS/2	PS/2	Speaker	2	VGA	PS/2	PS/2	Speaker	Permanently integrated PC connection cables	Audio-support
DC 0C12U	VGA	PS/2	PS/2		2	VGA	USB			Permanently integrated PC connection cables	Integrated PS/2 to USB converter
DS-11200	VGA	PS/2	USB		2	VGA	USB			Permanently integrated PC connection cables	
DS-12200	VGA	PS/2	USB		4	VGA	USB			Permanently integrated PC connection cables	
DS-11402-1	VGA	PS/2	USB	Speaker	2	VGA	USB	Speaker		Integrated PC connection cables, removable	Audio-support - audio separately switchable
DS-11404	VGA	PS/2	USB	Speaker	2	VGA	USB	Speaker		Permanently integrated PC connection cables	Datentransfer zwischen den angeschlossenen PCs, Bild-in-Bild-Funktion
DC 1C612I	VGA	PS/2	PS/2		2	VGA	PS/2	PS/2		Integrated PC-connection cables, removable, alternative cables: ●	
DC 1C614I	VGA	PS/2	PS/2		4	VGA	PS/2	PS/2		Integrated PC-connection cables, removable, alternative cables: ●	
DS-11802-1	DVI	USB	USB	Speaker	2	DVI	USB	Speaker		Integrated PC connection cables, removable	DVI; audio-support - audio separately switchable
DS-11900	HDMI	USB	USB	Speaker *2	2	HDMI	USB	Speaker		Integrated PC connection cables, removable	*2 Sounds over HDMI connection

* Cabletypes on page 100

DIGITUS® KM Switch with File Transfer

The easy control and file transfer solution for your Notebook and Desktop computer

The Console switching cable let you conveniently access two computers at the same time with only one mouse and one keyboard by using both screens simultaneously. Built-in file transfer utility for Backups, syncing and transferring files between the connected computers. The KM Cable also features a shared Clipboard function for easy „copy and paste“ and an integrated Picture-in-Picture mode.

- KM function allows user to control two computers and associated monitors with only one keyboard and one mouse
- File and data transfer between two computers
- Copy and Paste text between two computers
- Picture in Picture (PIP) function
- Portable all-in-one cable design, needs only one USB 2.0 connection on each computer
- USB 2.0 compatible
- Built-in driver and software, works without driver installation from CD-ROM
- No external power supply needed
- Switching between computers via mouse movement or application
- Supports Windows 7, Vista and XP



Datatransfer

273837 / DS-16101
KM Switch with File Transfer

DIGITUS® pocket KVM switch PS/2, 2-port

Ready to work right out of the box - Unclutter your desktop and simplify your workspace

Controls two PCs with one PS/2 keyboard, one PS/2 mouse, and one monitor

- Simple installation - no additional software required
- PC selection via hot key
- Excellent video quality - up to 1920 x 1440 pixels, 200MHz bandwidth
- Supports DDC, DDC2, DDC2B, DDC2AB
- Hot plug and play
- Keyboard and mouse emulation ensuring an error-free boot-up procedure of the computer
- Auto-scan function (5, 10, 15, 20, 25, 30 sec. selectable) / auto-skip function
- No external power supply needed
- KVM cable integrated for connection of two PCs, 1.2m
- Supports standard PS/2 mouse, Microsoft IntelliMouse, and full support of Microsoft IntelliPoint 5.0 mouse driver & Logitech Mouse Ware driver
- Operating systems supported: Windows 95 / 98 / 98SE / ME / NT 4.0 / 2000 / XP / Vista / DOS / Linux / Novell Netware / FreeBSD

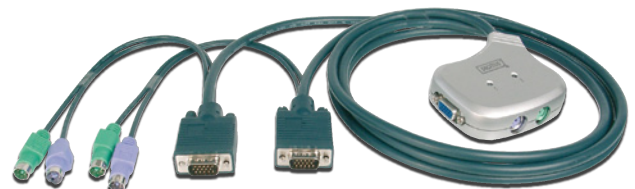

Warranty 5 Years
CERTIFIED HI-SPEED USB 2.0
BLEETER

159056 / DC 0C12
Pocket KVM switch PS/2, 2-port

159063 / DC 0C12A
Pocket KVM switch PS/2 with audio, 2-port

174325 / DC 0C12U
Pocket KVM switch PS/2, 2-port for USB PC

DIGITUS® USB pocket KVM switch, 2-Port

The easiest and fastest way to combine two PCs/Notebooks with one workplace.

Controls two PCs with one USB keyboard, one USB mouse and one VGA monitor

- Simple installation - no additional software required
- PC selection via hotkey or push-button
- Excellent video quality - up to 2048x1536 pixels at 85Hz
- Supports DDC, DDC2, DDC2B, DDC2AB
- Audio IN/OUT - support, separately switchable
- Hot plug and play
- Keyboard and mouse emulation for error free system boot
- Autoscan (5 to 60 sec., selectable)
- No external power supply required for operation
- Integrated KVM cable for connection of two PCs 1.2m
- Supports all Windows-, Linux- and Mac operating systems with USB support



273295 / DS-11402-1
USB pocket KVM switch, 2-Port

DIGITUS® USB pocket KVM switch for DVI, 2-port

The easiest and fastest way to combine two PCs/Notebooks with one workplace.

Controls two PCs with one USB keyboard, one USB mouse and one DVI monitor

- Complete DVI-D feature support
- Simple installation - no additional software required
- PC selection via hotkey or push-button
- Excellent video quality - up to 1920x1080 pixel at 60Hz
- Supports DDC, DDC2 monitors
- Audio IN/OUT - support, separately switchable
- Plug and Play and hot-swappable
- Keyboard and mouse emulation for error free booting
- Autoscan (5 to 60 sec., selectable)
- No external power supply required for operation
- Integrated KVM cable for connection of two PCs 1.2m
- Supports all Windows-, Linux- and Mac operating systems with USB support



273301 / DS-11802-1
USB pocket KVM switch for DVI, 2-port

DIGITUS® USB pocket KVM switch for HDMI, 2-port

HDMI 1080p support

Enjoy FullHD video and audio sound from two PCs sharing one set of HDMI monitor, keyboard and mouse.

- Controls two PCs with one USB keyboard, one USB mouse and one HDMI monitor
- Complete HDMI feature support
- Compliant with HDMI High Speed
- Simple installation - no additional software required
- Excellent video quality - up to 1920x1200 pixel at 60Hz or 1080p
- Audio support via HDMI connection
- Plug and Play and hot-swappable
- Keyboard and mouse emulation for error free booting
- Autoscan (Interval 10 sec.)
- No external power supply required for operation
- Integrated KVM cable for connection of two PCs 1.2m
- Supports all Windows-, Linux- and Mac operating systems with USB support



290773 / DS-11900
USB pocket KVM switch for HDMI, 2-port

DIGITUS® Pocket KVM switch with Data Link function

The easiest and fastest way to combine two PCs/Notebooks with one workplace.

This KVM combines a standard KVM switch with a data link cable. Copy easily files via "Drag and Drop" using the Picture in Picture function from one PC to another. Using only one set of keyboard, mouse, monitor and speaker for two PCs makes this product to the optimal solution for handling two PCs.

- Access two PCs with one set of keyboard, mouse, monitor and speaker
- Perform Data Transfer between two computers
- Data Link function conforms to the High Speed USB specification
- Compatible to USB 1.1/2.0 specifications
- Supports PIP function
- Select PCs by using push button or Hot-key commands or software application
- Independent switching of KVM and Audio
- Max. resolution is up to 2048x1536 pixels
- Supports DDC, DDC2, and DDC2B.
- No external power supply needed
- Integrated cable set, length 1,2m
- Dimensions (LxWxH, weight): 82x88x25mm, 355g
- Supports Windows 7, Vista and XP

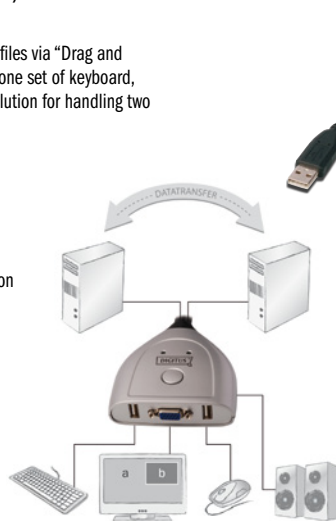

AUDIO + Datatransfer



285502 / DS-11404

Pocket KVM switch with Data Link function

DIGITUS® pocket KVM switch USB, 2-port

Ready to work right out of the box - Unclutter your desktop and simplify your workspace

Controls two PCs with one USB keyboard, one USB mouse, and one monitor

- Simple installation - no additional software required
- PC selection via hot keys or mouse click function
- Excellent video quality - up to 2048x1536 pixels, 200MHz bandwidth
- Supports DDC, DDC2, DDC2B, DDC2AB
- Hot plug and play
- Keyboard and mouse emulation ensuring an error-free boot-up procedure of the computer
- Auto-scan function (5, 10, 15, 20, 25, 30 sec. selectable) / auto-skip function
- No external power supply needed
- KVM cable integrated for connection of two PCs, 1.2m
- Supports Windows, Mac and Linux



DS-11200



DS-12200



289517 / DS-11200

Pocket KVM switch USB, 2-port

289555 / DS-12200

Pocket KVM switch USB, 4-port

DIGITUS® compact KVM switch PS/2, 2-port

Ready to work right out of the box - Unclutter your desktop and simplify your workspace

Controls several PCs with one PS/2 keyboard, one PS/2 mouse, and one monitor

- Simple installation - no additional software required
- PC selection via push buttons or hot key
- Excellent video quality - up to 1920 x 1440 pixels, 200MHz bandwidth
- Supports DDC, DDC2, DDC2B, DDC2AB
- Hot plug and play
- Keyboard and mouse emulation ensuring an error-free boot-up procedure of the computer
- Auto-scan function (5, 10, 15, 20, 25, 30 sec. selectable) / auto-skip function
- No external power supply needed
- Incl. cable sets
- Supports standard PS/2 mouse, Microsoft IntelliMouse, and full support of Microsoft IntelliPoint 5.0 mouse driver & Logitech Mouse Ware driver
- Operating systems supported: Windows 95 / 98 / 98SE / ME / NT 4.0 / 2000 / XP / Vista / DOS / Linux / Novell Netware / FreeBSD
- Optional KVM cable: DS-19121 (1.8m), DS-19122 (3.0m), DS-19123 (5.0m), DS-19124 (7.0m), DS-19125 (10.0m)



DC IC614I



DC IC612I



Usable cabletype: p.: 100

117766 / DC IC612I

KVM switch PS/2, 2-port

117773 / DC IC614I

KVM switch PS/2, 4-port

Product comparison table Desktop KVMs - Basic-Line

	Consoles- / Working side				Supported PC connections					useable cables *	Specifics
	Monitor	Keyboard	Mouse	Sound	Number of PCs	Monitor	Keyboard	Mouse	Sound		
DS-11110	VGA	PS/2	PS/2		2	VGA	PS/2	PS/2		cables: ●●●	Switching by mouse clicking possible; with adapter cable ● also usable with USB-PCs
DS-12110	VGA	PS/2	PS/2		4	VGA	PS/2	PS/2		cables: ●●●	Switching by mouse clicking possible; with adapter cable ● also usable with USB-PCs
DS-13110	VGA	PS/2	PS/2		6	VGA	PS/2	PS/2		cables: ●●●	Switching by mouse clicking possible; with adapter cable ● also usable with USB-PCs
DS-13111	VGA	PS/2	PS/2		8	VGA	PS/2	PS/2		cables: ●●●	Switching by mouse clicking possible; with adapter cable ● also usable with USB-PCs
DS-11310	VGA	PS/2	PS/2	●	2	VGA	PS/2	PS/2	●	cables: ●●●● (2 cable sets included)	Switching by mouse clicking possible; with adapter cable ● also usable with USB-PCs
DS-12310	VGA	PS/2	PS/2	●	4	VGA	PS/2	PS/2	●	cables: ●●●● (4 cable sets included)	Switching by mouse clicking possible; with adapter cable ● also usable with USB-PCs
DS-13112	VGA	PS/2	PS/2		8	VGA	PS/2	PS/2		cables: ●●●	Switching by mouse clicking possible; with adapter cable ● also usable with USB-PCs; OSD
DC-11403	VGA	USB	USB	●	2	VGA	USB		●	cables: ●●	Switching by mouse clicking possible
DC-12402	VGA	USB	USB	●	4	VGA	USB		●	cables: ●●	Switching by mouse clicking possible
DS-11510	DVI	PS/2	PS/2		2	DVI	PS/2	PS/2		cables: ●	
DS-12510	DVI	PS/2	PS/2		4	DVI	PS/2	PS/2		cables: ●	

* cable-types on page 100/101

DIGITUS® USB-KVM switch with audio

Unclutter your desktop and simplify your workspace - saves space and money

Controls PCs with one USB keyboard, one USB mouse, and one monitor

- Speaker & microphone can be connected
- Simple installation - no additional software needed
- Selection of PC via push buttons, hot keys, or mouse click (hot key function can be switched off)
- Excellent video quality - up to 1920 x 1440 pixels, 200MHz bandwidth
- DDC, DDC2, DDC2B, DDC2AB support
- Hot pluggable, plug and play
- Operating systems supported: Windows / Linux / MacOS
- Optional KVM cable: AK 82301 (1.8m), AK 82302 (3.0m), AK 82303 (5.0m)
- Optional audio cable: AK 82101 (1.8m), AK 82102 (3.0m), AK 82103 (5.0m)

AUDIO



Usable cabletype: p.: 100



223863 / DC-11403
USB-KVM switch with audio and mouseclicking, 2-port

223870 / DC-12402
USB-KVM switch with audio and mouseclicking, 4-port

DIGITUS® desktop KVM switch PS/2, with mouse clicking function

Simplify your workspace with only one monitor, keyboard and mouse for all connected computers - saves space and money

Controls simply, comfortably and cost-saving several PCs with one console with one monitor, one keyboard and one mouse.

- Controls PCs via a PS/2 keyboard, a PS/2 mouse and a monitor
- Easy installation - no software required
- PC selection via buttons, hot keys or mouse click (hot key function can be switched off)
- Excellent video quality - up to 1920x1440 pixels, 200MHz bandwidth
- Supports DDC, DDC2, DDC2B, DDC2AB
- Hot plug and play
- Keyboard and mouse emulation for error free booting of the computer
- Autoscan (5,10,15,20,25,30 sec. options) / autoskip function
- No external power supply required (optional power supply 9V DC, 300mA - Art.-Nr. DS-15100)
- Supports Standard-PS/2-mouse, Microsoft IntelliMouse plus complete support for Microsoft IntelliPoint 5.0 mouse drivers & Logitech Mouse ware-drivers
- Optional KVM cable: DS-19121 (1.8m), DS-19122 (3.0m), DS-19123 (5.0m), DS-19124 (7.0m), DS-19125 (10.0m)



Usable cabletype: p.: 100



- 258117 / DS-11110**
KVM switch PS/2 with mouseclicking, 2-port
- 258131 / DS-12110**
KVM switch PS/2 with mouseclicking, 4-port
- 258162 / DS-13110**
KVM switch PS/2 with mouseclicking, 6-port

DIGITUS® KVM switch PS/2 with audio

AUDIO



Usable cabletype: p.: 100

Simplify your workspace with only one monitor, keyboard and mouse for all connected computers - saves space and money

Controls simply, comfortably and cost-saving several PCs with one console with one monitor, one keyboard and one mouse and offers audio support for speaker and microphone.

- Controls PCs via a PS/2 keyboard, a PS/2 mouse and a monitor
- PC selection via buttons, hot keys or mouse click (hot key function can be switched off)
- Excellent video quality - up to 1920x1440 pixels, 200MHz bandwidth
- Supports DDC, DDC2, DDC2B, DDC2AB - Hot plug and play
- Keyboard and mouse emulation for error free booting of the computer
- Autoscan (5,10,15,20,25,30 sec. options) / autoskip function
- Supports Standard-PS/2-mouse, Microsoft IntelliMouse plus complete support for Microsoft IntelliPoint 5.0 mouse drivers & Logitech Mouse ware-drivers
- Audio support for speakers and microphone
- Package Content: 1x KVM switch; 1x user manual; 1x power supply DC 9V 300mA; 2x cable sets
- Optional cables:
KVM: DS-19121 (1.8m), DS-19122 (3m), DS-19123 (5m), DS-19124 (7m), DS-19125 (10m)
Audio: AK 82101 (1.8m), AK 82102 (3.0m), AK 82103 (5.0m)



- 258148 / DS-11310**
KVM switch PS/2 with audio and mouseclicking, 2-port
- 258155 / DS-12310**
KVM switch PS/2 with audio and mouseclicking, 4-port

DIGITUS® KVM switch DVI

DVI



Usable cabletype: p.: 100

Simplify your workspace with only one monitor, keyboard and mouse for all connected computers - saves space and money

Controls simply, comfortably and cost-saving several PCs with one console with one monitor, one keyboard and one mouse.

- Access and controls PCs with one PS/2 keyboard, mouse and one DVI monitor
- Supports standard PS/2 mouse, Microsoft IntelliMouse, and full support of Microsoft IntelliPoint 5.0 mouse driver & Logitech Mouse Ware driver
- Resolution up to 1280x1024 pixels, DDC2
- Selection via Push button and Hotkey
- Easy installation - no software required
- Hot plug and play
- Keyboard and mouse emulation for error free system boot
- Autoscan (5,10,15,20,25,30 sec. options) / autoskip function
- Optional KVM cable: AK 809 (1.8m), AK 809 3M, AK 809 5M



- 258193 / DS-11510**
KVM switch PS/2 DVI, 2-port
- 258209 / DS-12510**
KVM switch PS/2 DVI, 4-port

Product comparison table Desktop KVMs - Combo-Line

	Consoles - / Working side				Supported PC connections				useable cables *	Specifics	
	Monitor	Keyboard	Mouse	Sound	Number of PCs	Monitor	Keyboard	Mouse			Sound
DC-11202-1	VGA	PS/2 USB	PS/2 USB		2	VGA	PS/2 and / or USB (Combo-switch)			cables (2 x 1,8m cable sets included)	Keyboard and mouse connections freely selectable
DC-12202-1	VGA	PS/2 USB	PS/2 USB		4	VGA	PS/2 and / or USB (Combo-switch)			cables (2 x 1,8m cable sets included)	Keyboard and mouse connections freely selectable
DS-13202	VGA	PS/2 USB	PS/2 USB		8	VGA	PS/2 and / or USB (Combo-switch)			cables (2 x 1,8m cable sets included)	Keyboard and mouse connections freely selectable; firmware upgradable
DS-14202	VGA	PS/2 USB	PS/2 USB		16	VGA	PS/2 and / or USB (Combo-switch)			cables (2 x 1,8m cable sets included)	Keyboard and mouse connections freely selectable; firmware upgradable
DC-11401-1	VGA	PS/2 USB	PS/2 USB		2	VGA	PS/2 and / or USB (Combo-switch)			cables (2 x 1,8m cable sets included)	Keyboard and mouse connections freely selectable; audio support, audio separately switchable
DC-12401-1	VGA	PS/2 USB	PS/2 USB		4	VGA	PS/2 and / or USB (Combo-switch)			cables (2 x 1,8m cable sets included)	Keyboard and mouse connections freely selectable; audio support, audio separately switchable
DC-11201-1	VGA	PS/2 USB	PS/2 USB		2	VGA	USB			cables (2 x 1,8m cable sets included)	Keyboard and mouse connections freely selectable at the KVM; incl. 3-port USB 2.0 Hub
DC-12201-1	VGA	PS/2 USB	PS/2 USB		4	VGA	USB			cables (2 x 1,8m cable sets included)	Keyboard and mouse connections freely selectable at the KVM; incl. 3-port USB 2.0 Hub
DS-12403	VGA	PS/2 USB	PS/2 USB		4	VGA	USB			cables (2 x 1,8m cable sets included)	Keyboard and mouse connections freely selectable at the KVM; audio support, audio separately switchable; incl. 2-port USB 2.0 Hub
DS-12404	2x VGA	PS/2 USB	PS/2 USB		4	2x VGA	USB			cables (4 x 1,8m cable sets included)	Keyboard and mouse connections freely selectable at the KVM; audio support, audio separately switchable; incl. 2-port USB 2.0 Hub, supports 2 monitors
DC-11801-1	DVI	PS/2 USB	PS/2 USB		3	DVI	USB			cables (2 x 1,8m cable sets included)	Keyboard and mouse connections freely selectable at the KVM; audio support, audio separately switchable
DS-12800	DVI	PS/2 USB	PS/2 USB		4	DVI	USB			cables (2 x 1,8m cable sets included)	Keyboard and mouse connections freely selectable at the KVM; audio support, audio separately switchable; incl. 2-port USB 2.0 Hub

* cable-types on page 100

DIGITUS® audio USB-PS/2 Combo-KVM switch

Unclutter your desktop and simplify your workspace - saves space and money

Controls several PCs with one PS/2 or USB keyboard, one PS/2 or USB mouse, and one monitor, incl. audio support

- Simple installation - no additional software needed
- Selection of PC via push buttons or hot key
- Excellent video quality - up to 2048 x 1536 pixels at 85Hz
- Supports DDC, DDC2 monitors
- Hot plug and play
- Keyboard and mouse emulation ensuring an error-free boot-up procedure of the computer
- Autoscan (5 to 250 sec., selectable)
- No external power supply needed, self-powered by PS/2 or USB connection (optional power supply 5V; 2.0A - Art.-Nr. DN-R-PS-1)
- Fully compliant with USB 1.1/2.0 specifications
- Two cable sets included in delivery, length: 1.8m
- Supports Windows®, Mac, Linux and Sun Micro Systems
- Optional KVM cable: AK 82001 (1.8m), AK 82002 (3.0m), AK 82003 (5.0m), AK 82004 (PS/2 - 10.0m), AK 82304 (USB - 10.0m)
- Optional audio cable: AK 82101 (1.8m), AK 82102 (3.0m), AK 82103 (5.0m)

AUDIO

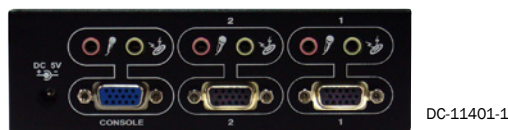

- Usable cabletype: p.: 100
- Usable cabletype: p.: 100
- Usable cabletype: p.: 100

222651 / DC-11401-1
Audio USB-PS/2 Combo-KVM switch, 2-port

222668 / DC-12401-1
Audio USB-PS/2 Combo-KVM switch, 4-port



DIGITUS® USB 2.0-KVM switch, 2-port

USB 2.0 Hub



Usable cabletype: p.: 100

Unclutter your desktop and simplify your workspace - saves space and money

Controls up to two PCs with one keyboard, one mouse, and one monitor

- Universal use with USB and PS/2 devices
- Integrated 3-Port USB 2.0 Hub
- Simple installation - no additional software required
- PC selection via push buttons, hot key, or OSD utility
- Excellent video quality - up to 1920x1440 pixels, 200MHz bandwidth
- Supports DDC, DDC2
- Hot plug and play
- Keyboard and mouse emulation ensuring an error-free boot-up procedure of the computer
- Auto-scan function (5 to 250 sec., selectable)
- Delivery incl. two cable sets with 1,8m length
- Supports Windows®, Mac, Linux and Sun Micro Systems
- Optional KVM cable: AK 82301 (1.8m), AK 82302 (3.0m), AK 82303 (5.0m)



222583 / DC-11201-1

USB 2.0-KVM switch, 2-port

DIGITUS® USB-PS/2 Combo-KVM switch



Usable cabletype: p.: 100

Usable cabletype: p.: 100

Unclutter your desktop and simplify your workspace - saves space and money

Controls several PCs with one PS/2 or USB keyboard, one PS/2 or USB mouse, and one monitor

- Simple installation - no additional software required
- PC selection via push buttons or hot key
- Excellent video quality - up to 2048 x 1536 pixels at 85Hz
- Supports DDC, DDC2 monitors
- Hot plug and play
- Keyboard and mouse emulation ensuring an error-free boot-up procedure of the computer
- Auto-scan function (5 to 250 sec., selectable)
- No external power supply needed, self-powered via PS/2 or USB connection (optional power supply 5V; 2.0A - Art.-Nr. DN-R-PS-1)
- Fully compliant with USB 1.1 and USB 2.0 specifications
- Two cable sets included in delivery, 1.8m each cable
- Supports Windows®, Mac, Linux and Sun Micro Systems
- Optional KVM cable: AK 82001 (1.8m), AK 82002 (3.0m), AK 82003 (5.0m), AK 82004 (PS/2 - 10.0m), AK 82304 (USB - 10.0m)



222637 / DC-11202-1

USB-PS/2 Combo-KVM switch, 2-port

222644 / DC-12202-1

USB-PS/2 Combo-KVM switch, 4-port

DIGITUS® USB 2.0-KVM switch, 4-port

USB 2.0 Hub



Usable cabletype: p.: 100

Unclutter your desktop and simplify your workspace - saves space and money

Controls up to four PCs with one keyboard, mouse and monitor

- Universal use with USB and PS/2 devices
- Integrated 3-Port USB 2.0 Hub
- Simple installation - no additional software required
- PC selection via push buttons, hot key, or OSD utility
- Excellent video quality - up to 1920x1440 pixels, 200MHz bandwidth
- Supports DDC, DDC2
- Hot plug and play
- Emulates a keyboard and a mouse on each PC to allow your computers to boot normally without a keyboard error
- Auto-scan function (5 to 250 sec., selectable)
- Incl. external Power DC 5V 2A
- Delivery incl. two cable sets with 1,8m length
- Supports Windows®, Mac, Linux and Sun Micro Systems
- Optional KVM cable: AK 82301 (1.8m), AK 82302 (3.0m), AK 82303 (5.0m)



222590 / DC-12201-1

USB 2.0-KVM switch, 4-port

DIGITUS® audio combo KVM switch - DVI, 3-port

DVI



Usable cabletype: p.: 100

Usable cabletype: p.: 100

Unclutter your desktop and simplify your workspace - saves space and money

Controls up to three PCs with one PS/2 or USB keyboard, one PS/2 or USB mouse, and one DVI monitor, incl. audio support

- Simple installation - no additional software needed
- Selection of PC via push buttons or hot key
- Excellent video quality - up to 1600 x 1200 pixels at 60Hz
- DDC, DDC2, DVI, UXGA support
- Hot plug and play
- Emulates a keyboard and a mouse on each PC to allow your computers to boot normally without a keyboard error
- Autoscan (5 to 250 sec., selectable)
- No external power supply needed, self-powered by PS/2 or USB connection (optional power supply 5V; 2.0A - Art.-Nr. DN-R-PS-1)
- Fully compliant with USB 1.1/2.0 specifications
- Two cable sets included in delivery, length: 1.8m
- Supports Windows®, Mac, Linux and Sun Micro Systems
- Optional USB / Audio cable: AK 82201 (1.8m), AK 82202 (3.0m), AK 82203 (5.0m)
- Optional DVI cable: AK-110019 (1.8m), AK-110020 (3.0m), AK-110021 (5.0m)



222620 / DC-11801-1

Audio combo KVM switch DVI, 3-port

DIGITUS® Audio-USB-KVM switch, 2-port, with integrated USB 2.0 Hub

Simplify your workspace with only one monitor, keyboard and mouse for all connected computers - saves space and money

This high-qualitative KVM-switch allows the simultaneous or separate control of up to two PCs, supports audio and additional two USB-peripherals like scanner, printer, camera or something else..

- Controls two computers from a single console (keyboard/mouse) over USB
- Integrated USB-Hub - two computers can share two USB downstream ports
- USB 2.0 compliant
- Provides HUB switching in independent method or combination with the host switching (USB HUB Auto-Switch mode)
- Provides audio switching in independent method
- Supports VGA interface
- Superior video quality - resolutions up to WUXGA 1920x1200 at 60Hz
- PC selection via push button on front panel and/or hot keys on USB keyboard
- Auto scan function (Time interval can be adjusted between 5-20 seconds when the Auto-Scan function is enabled)
- LED display for easy status monitoring
- Plug and play
- Supports Windows®, Mac, Linux and Sun Micro Systems
- Optional KVM cable: AK 82301 (1.8m), AK 82302 (3.0m), AK 82303 (5.0m)
- Optional audio cable: AK 82101 (1.8m), AK 82102 (3.0m), AK 82103 (5.0m)



307235 / DS-12423
USB 2.0-Audio-KVM switch, 2-port

307242 / DS-12443
USB 2.0-Audio-KVM switch, 4-port

DIGITUS® DVI-Audio-USB-KVM switch, 2-port, with integrated USB 2.0 Hub

Simplify your workspace with only one monitor, keyboard and mouse for all connected computers - saves space and money

This high-qualitative DVI-KVM-Switch allows the simultaneous or separate control of up to two PCs, supports audio and additional two USB-peripherals like scanner, printer, camera or something else.

- Controls two computers with DVI video from a single console (keyboard/mouse) over USB
- Integrated USB-Hub - two computers can share two USB downstream ports
- USB 2.0 compliant
- Provides HUB switching in independent method or combination with the host switching (USB HUB Auto-Switch mode)
- Provides audio switching in independent method
- Supports DVI interface
- Superior video quality - resolutions up to WUXGA 1920x1200 at 60Hz
- PC selection via push button on front panel and/or hot keys on USB keyboard
- Auto scan function (Time interval can be adjusted between 5-20 seconds when the Auto-Scan function is enabled)
- LED display for easy status monitoring
- Plug and play
- Supports Windows®, Mac, Linux and Sun Micro Systems
- Optional USB / Audio cable: AK 82201 (1.8m), AK 82202 (3.0m), AK 82203 (5.0m)
- Optional DVI cable: AK-320102-020-S (2.0m), AK-320102-030-S (3.0m), AK-320102-050-S (5.0m)



307259 / DS-12820
USB 2.0-DVI-Audio-KVM switch, 2-port

307266 / DS-12840
USB 2.0-DVI-Audio-KVM switch, 4-port

DIGITUS® Dual VGA Combo KVM Switch, 4-port, with audio support and USB Hub

USB 2.0 Hub
+ AUDIO
+ 2 Display



The perfect KVM for Multimedia- and Graphic workstations with two monitors

This KVM allows you to pair up to four computers with dual-screen support with two VGA displays, one set of keyboard and mouse, a microphone and a speaker set. Furthermore you can share any desired USB device which is connected to the integrated USB hub with your computers.

- Controls up to four dual-video (VGA) enabled computers from a single console with two monitors
- Supports PS/2 keyboard / mouse and USB keyboard / mouse
- Easy installation - no software required
- Integrated USB 2.0 hub, independent switchable
- Hot plug and play
- PC selection via hotkey or push-button
- Excellent video quality - up to 2048x1536 pixels at 85Hz
- Supports DDC and DDC2 monitors
- Audio IN/OUT - support, separately switchable
- Keyboard and mouse emulation for error free booting
- Autoscan- (5 to 60 sec.)
- Supports all Windows-, Linux- and Mac operating systems with USB support
- Optional KVM cable: AK 82301 (1.8m), AK 82302 (3.0m), AK 82303 (5.0m)



Usable
cabletype:
p.: 100



275824 / DS-12404
4-Port Dual VGA Combo KVM Switch, audio, USB Hub

KVM - example of use

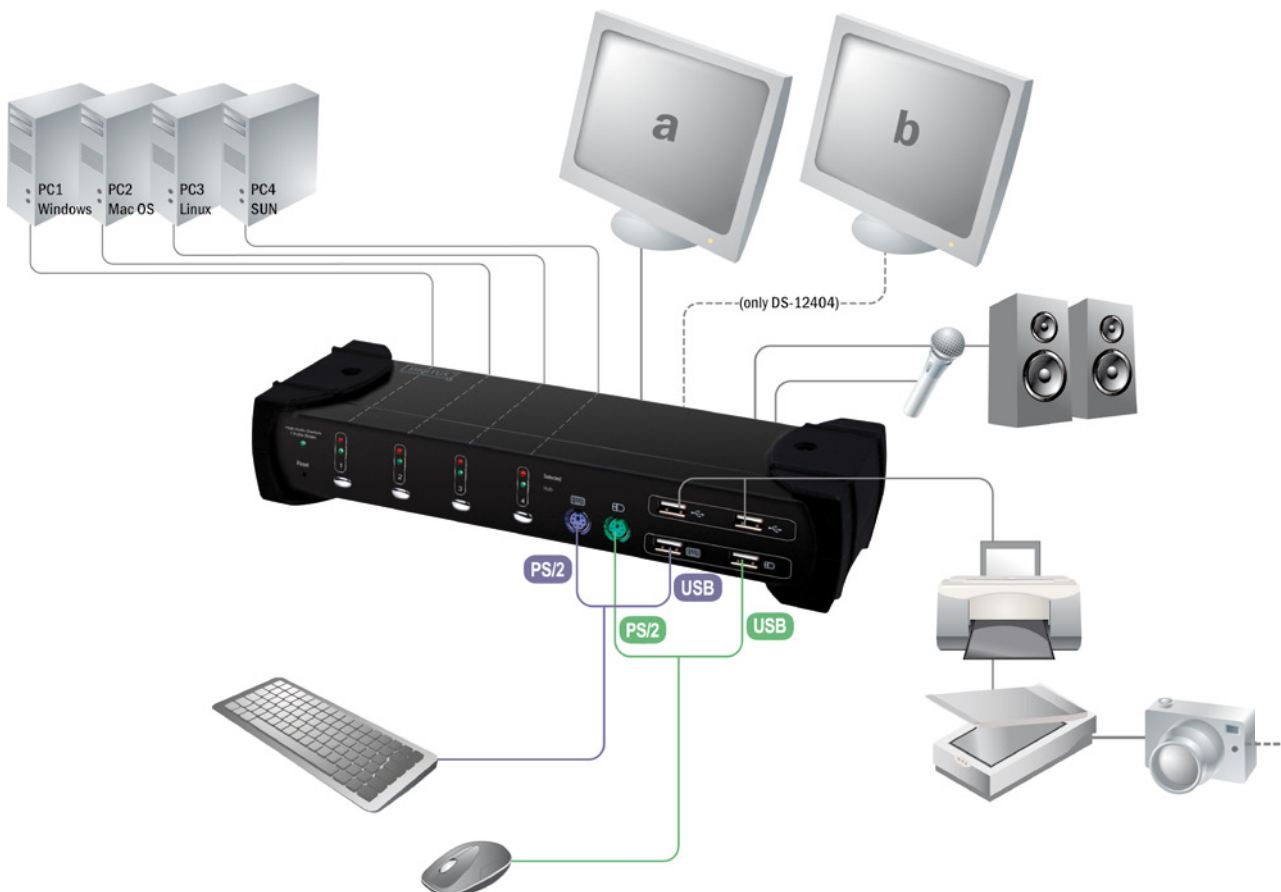

DIGITUS® Combo KVM Extender with USB and PS/2

This Combo KVM Extender allows an extension of VGA video, USB, and / or PS/2 signals up to a distance of 200 meters away from the signal source. With the built-in video and keyboard/mouse signal amplifiers an excellent quality of video resolutions can be achieved.

- Extends keyboard, video, and mouse signals via Cat5 cables
- Dual console operation possible - controls your system locally and remotely
- Push button at local side to select active console
- Options available to control console settings: local / remote / local and remote
- Local and remote consoles allow connections of USB and / or PS/2 keyboards / computer mice
- Allows computer connections via USB and / or PS/2 interfaces at local console
- Supports high video resolutions of up to 1920x1080 pixels at max. 75m; 1280x1024 pixels up to 200m, at 60Hz
- Remote monitor DDC2B supported
- Control of focus, brightness, and color skew at remote side ensures perfect video quality
- No software or driver installations required
- Supports access to BIOS level
- LEDs on both devices indicate active console and connection status
- Firmware upgradeable
- Supports Windows®, Mac, Linux and Sun Micro Systems
- Dimensions local / remote (L x W x H): 125mm x 78mm x 46mm

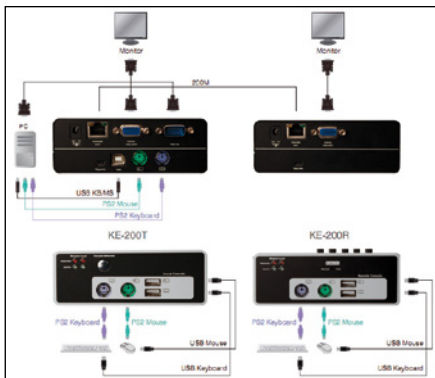

Local



Remote



263142 / DS-51110
Combo KVM Extender

DIGITUS® USB KVM Extender over Cat 5

Move your console to the most convenient place – Enjoy flexibility!

Extends the Video, USB Keyboard and Mouse signal by Cat 5 up to 200m

- High resolution video up to 1280x1024 @ 60Hz for distances of up to 200 meters
- High quality resolutions thanks to the built-in video, keyboard and mouse signal enhancement
- Dual console operation - Control your system from both the local and remote unit
- Selection of the active console via push button at local side
- Three active console options: local console / remote console / both consoles
- Supports keyboard/mouse connection of USB interface to computer at local side
- DDC2B support for remote monitor
- No software or driver installation required
- Supports BIOS level operation
- Firmware upgradeable
- Compatible with most commonly used operating systems like DOS, Windows 98SE/ME/2000/XP/2003 Server/Vista/7, Linux, Mac OS9/OSX and Sun Microsystems



Local



Remote



306054 / DS-51200
USB KVM Extender over Cat 5 up to 200m

DIGITUS® KVM extender over Cat 5

Perfect for moving the console away from KVM switch to the most convenient place

The extension of VGA, PS/2 keyboard, PS/2 mouse signal up to 300 meter away by using the KVM Extender and one CAT 5 cable.

- Max. resolution 1280x1024 pixels
- Support Auto/Manual video quality adjustment
- Support video gain, equalization and RGB skew adjust
- Support three hot keys to combine other equipment
- Two control privilege modes - „Share“ & „Local only“
- Extra console port is available on Local side
- Auto console selection between Local and Remote



223825 / DC-51101

KVM extender 300m, local + remote

232711 / DC-51102

KVM extender 180m, local + remote

DIGITUS® RS232 extender, 1000m

Ideal for connecting distant placed devices and machines equipped with RS232 serial interface

Compatible with all RS232 protocols

- Full-duplex data communication
- Sends RS232 data at 230kbps up to 1000m (3300ft.)
- Pure hardware solution - real time data transfer, no software conflicts
- Transfer data or files between PCs, equipments
- Extension over CAT 5 cable
- Connections locale and remote side: 1x DB-9 Female; 1x RJ45 Female; power supply



223887 / DC-52101

RS232 extender

DIGITUS® Cat 5 Audio Extender

Uses a simple Ethernet cable to extend audio and microphone signals

With the DIGITUS® CAT 5 Audio Extender you are able to extend audio stereo and microphone signals up to 300 meter away by using the Audio Extender and one CAT 5 cable.

- Extension of audio signals up to 300m
- Audio Out supports multimedia speakers, Headphones or Earphones
- Mic In supports Condenser Microphone and Dynamic Microphone
- Built-in Microphone preamplifier
- Microphone gain can be adjustable



254768 / DC-56100

Cat 5 Audio Extender, 300m

DIGITUS® Octopus KVM Cable set

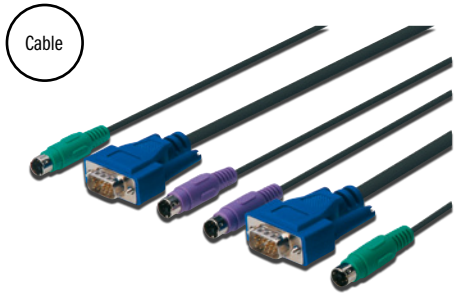

DIGITUS® original accessory

Octopus cable set for KVM switches with PS/2-connectors and VGA-female connectors

- 2 x MiniDIN6 (PS/2), plug <-> 2 x MiniDIN6 (PS/2), plug
- 1 x HD DSUB, 15-pin, plug <-> 1 x HD DSUB, 15-pin, plug
- Color: black
- Connectors color coded: keyboard (violet), mouse (green), and monitor (blue)
- Suitable for DIGITUS® consoles DC-72101xx and console module DS-11210



274797 / DS-19131
KVM Cable set, PS/2 - 1.8m

274803 / DS-19132
KVM Cable set, PS/2 - 3.0m

274827 / DS-19133
KVM Cable set, PS/2 - 5.0m

274834 / DS-19134
KVM Cable set, PS/2 - 7.0m

274841 / DS-19135
KVM Cable set, PS/2 - 10.0m

DIGITUS® Octopus KVM Cable set



DIGITUS® original accessory

Octopus cable set for KVM switches with PS/2-connectors and VGA-jack connectors.

- 2 x MiniDIN6 (PS/2), plug <-> 2 x MiniDIN6 (PS/2), plug
- 1 x HD DSUB, 15-pin, plug <-> 1 x HD DSUB, 15-pin, jack
- Color: black
- Connectors color coded: keyboard (violet), mouse (green), and monitor (blue)



274612 / DS-19121
KVM Cable set, PS/2 - 1.8m

274711 / DS-19122
KVM Cable set, PS/2 - 3.0m

274742 / DS-19123
KVM Cable set, PS/2 - 5.0m

274773 / DS-19124
KVM Cable set, PS/2 - 7.0m

274780 / DS-19125
KVM Cable set, PS/2 - 10.0m

KVM cable for DIGITUS® KVM switches (Combo series)



DIGITUS® original accessory

DC-11101, DC-12101, DC-11301, DC-12301, DC-13101, DC-14101, DC-11202, DC-11202-1, DC-12202, DC-12202-1, DC-11401, DC-11401-1, DC-12401, DC-12401-1, DC-13201, DC-14201

- Color: black
- Connectors KVM side 1x HD DSUB, 15-pin, plug
- Connectors PC side 2x MiniDIN, 6-pin, plug; 1x USB A, plug; 1x HD DSUB, 15-pin, plug



201151 / AK 82001
KVM Cable set, PS/2 and USB - 1.8m

201168 / AK 82002
KVM Cable set, PS/2 and USB - 3.0m

201175 / AK 82003
KVM Cable set, PS/2 and USB - 5.0m

KVM cable for DIGITUS® KVM switches with audio (Combo series)

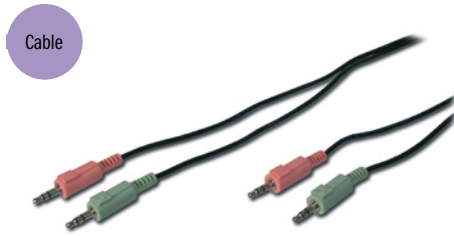

DIGITUS® original accessory

2 x 3.5mm stereo plug, male <=> 2 x 3.5mm stereo plug, male

- Color: black
- Suitable for: DC-11301, DC-11401, DC-11401-1, DC-12301, DC-12401, DC-12401-1, DC-11403, DC-12402
- Connections PC side 2x 3.5mm stereo plug
- Connections 2 x 3.5 mm stereo KVM side, plug
- Length 1.8 m



201182 / AK 82101
1.8m

201199 / AK 82102
3.0m

201205 / AK 82103
5.0m

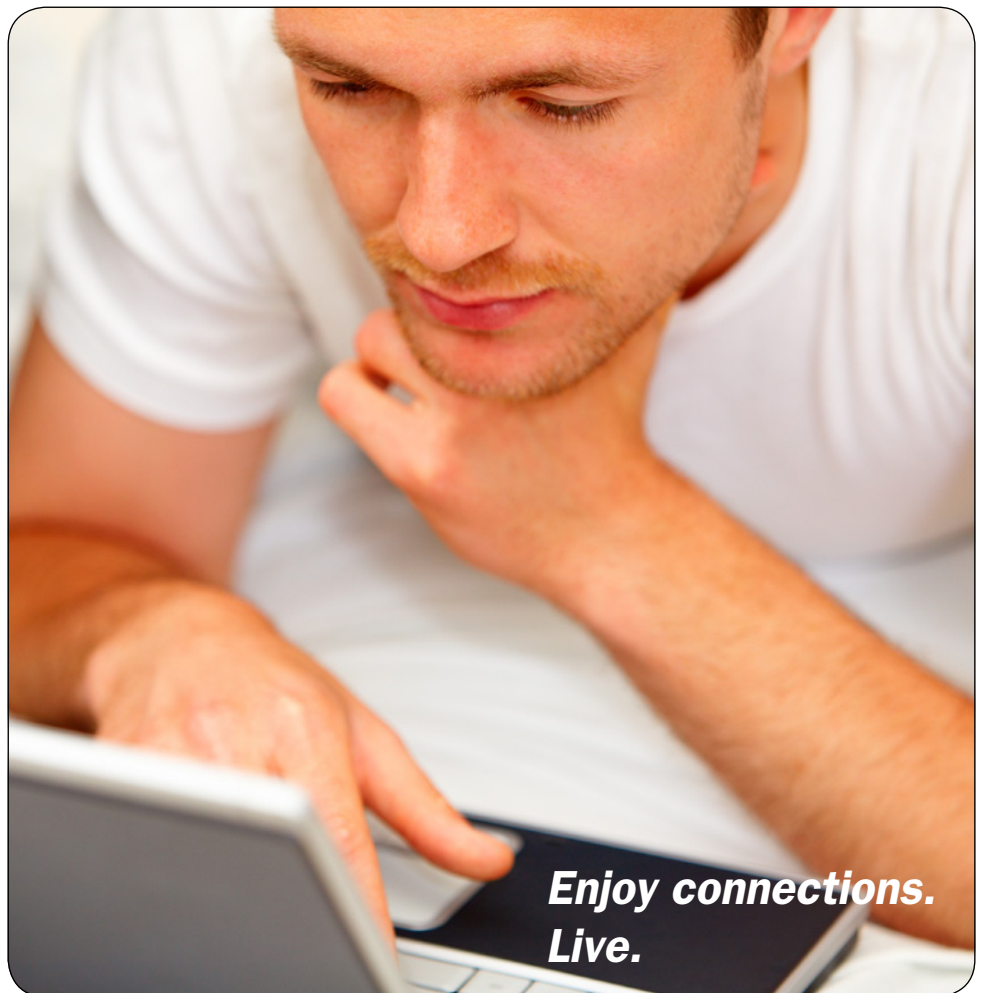

*Enjoy connections.
Live.*

KVM cable for DIGITUS® USB-KVM switches (Combo series)

Cable



DC-11201, DC-11201-1, DC-12201, DC-12201-1, DC-11403, DC-12402

- Color: black
- Connectors PC side 1x USB A, plug; 1x HD DSUB, 15-pin plug
- Connectors KVM side 1x USB B, plug; 1x HD DSUB, 15-pin, jack



201243 / AK 82301
KVM Cable set, USB - 1.8m

201250 / AK 82302
KVM Cable set, USB - 3.0m

201267 / AK 82303
KVM Cable set, USB - 5.0m

DIGITUS® KVM mounting frame



DIGITUS® original accessory

1 set of mounting frame composed of two brackets and mounting screws

- Suitable for DC-12202-1, DC-12401-1, DC-11801-1



206125 / DC-15001
KVM mounting frame for 4-port Combo KVMs

206132 / DC-15002
Mounting frame for 8-/16-port KVMs

KVM cable for DIGITUS® USB-KVM switches with audio (Combo series)

Cable



DC-11801, DC-11801-1

- Color: black
- Connectors PC side 1x USB A, plug; 2x 3,5mm, plug
- Connectors KVM side 1x USB B, plug; 2x 3,5mm, plug
- Length 1.8 m



201212 / AK 82201
1.8m

201229 / AK 82202
3.0m

201236 / AK 82203
5.0m

Rack Mount Kit for DIGITUS® USB KVM Extender



Two-Piece Rack Mount Kit consisting of a magnetic plate and a Rack Mount Bracket. This Kit enables you to integrate your DIGITUS® USB KVM Extender into a standard 19" Rack!

- Suitable for DS-51200 DIGITUS® USB KVM Extender
- Set: Magnetic plate and Rack Mount Bracket



306245 / DS-15003
Rack Mount Kit for DIGITUS® USB KVM Extender

DVI connection cable, DVI(24+5)/M to DVI(24+5)/M

Cable



This analog and digital, Full HD suitable DVI cable (Dual Link), is used to connect audio/video equipment with DVI(24+5) interface, such as PC, notebook, monitor, TV or a projector, for example.



298359 / AK-320102-020-S
2,0m

298366 / AK-320102-030-S
3,0

298373 / AK-320102-050-S
5,0

DIGITUS® Power Supply



Power Supply for DIGITUS® KVM (BASIC Line), DC 9V 1A, (Level V)



280736 / DS-15100
Power Supply, 9V 1A

223818 / DN-R-PS-1
Power Supply, 5V 2A

296775 / DS-15101
Power supply, DC 12V 1A (Level V)

286103 / DS-59900
Power supply 5V DC 4A

DIGITUS® HDMI Splitter, 2-Port

The best choice for carrying and splitting the HDMI signal to more than one display

Simultaneous display of one HDMI video signal on different output devices

- Easy to Use: Install in seconds, no need of setting
- Cascadeable: Large distribution achieved by cascading the HDMI Amplifier Splitter
- Highest supported video resolution 1080p
- Supports 3D all format, including 1080p@23.98/24Hz, 720p@59.94/60Hz/50Hz
- Bandwidth: 225MHz/2.25Gbps per channel(6.75Gbps all channel)
- Supports 12bit per channel (36bit all channel) deep color
- Supports HDCP
- Supports uncompressed audio such as LPCM
- Supports compressed audio such as DTS Digital, Dolby Digital (including DTS-HD and Dolby True HD)
- Dimensions (LxWxH; Weight): 155x70x23mm; 260g



271536 / DS-41300

HDMI Splitter, 2-Port

271543 / DS-42300

HDMI Splitter, 4-Port

DIGITUS® DIGITUS HDMI Video Switch with integrated PC connection

The convenient HDMI switch solution for your entertainment and home cinema system with full PC integration!

The solution to integrate your notebook or PC seamlessly into your home entertainment system! This USB 2.0 4+1 port HDMI Switch offers four HDMI inputs, one USB input port and one HDMI output. With our DS-45310 you can easily select source between HDMI and USB 2.0 with the Remote Control or the manual button.

- The ideal solution for comprehensively equipped home cinema and entertainment systems with Blue-Ray Player, Mediaplayer, Play Station, Receiver etc.
- The integrated Plug & Play USB 2.0 graphic adapter displays the picture of the PC on the connected television or monitor and therefore facilitates direct monitoring of the replayed videos (up to HD resolution)
- Four HDMI inputs, one USB 2.0 input and HDMI output
- Offers connection options for up to four devices with HDMI output and one PC via USB 2.0 interface to the HDMI compatible television, monitor or beamer
- Enables simple and seamless integration of a PC or notebook into the home cinema system via USB 2.0 connection
- The required source can be selected comfortably with the delivered remote control, or directly with the switch, to be displayed on the television or monitor
- Reduces the installation's wire mess and avoids replugging while switching between the different devices
- Share full HD video and audio from the computer on an HDTV
- 225MHz/2.25Gbps per channel (6.75Gbps all channels) bandwidth
- 12bit per channel (36bit all channels) deep color
- 3D all formats, including 1080p@23.98/24Hz, 720p@59.94/60Hz/50Hz



- USB 2.0 480Mbps bandwidth for connecting to computers
- USB 2.0 resolution max up to 1920x1080, including 1600x1200, 1.65Gbps/165MHz/24bits bandwidth
- Supported USB monitor modes: Primary, Extended, Mirror, Rotate
- Supports Windows 7, Vista, XP and Mac OS X



306085 / DS-45310

HDMI Matrix Switch, 4 x 2-Port

DIGITUS® HDMI Switch, 3-Port

Convenient switching between different HDMI sources without cable clutter

Select one HDMI video source out of several different to display it on one display

- Multi-switching methods: intelligent automatic, IR remote control or by touch button
- IR remote control included
- Highest supported video resolution 1080p
- Bandwidth: 250MHz/2.5Gbps per channel (7.5Gbps all channel)
- Supports 12bit per channel (36bit all channel) deep color
- Supports 3D all format, including 1080p@23.98/24Hz, 720p@59.94/60Hz/50Hz
- Supports HDCP
- Supports uncompressed audio such as LPCM
- Supports compressed audio such as DTS Digital, Dolby Digital (including DTS-HD and Dolby True HD)
- Dimensions (LxWxH; Weight): 80x58x18mm; 55g



271550 / DS-44300

HDMI Switch, 3-Port

271567 / DS-45300

HDMI Switch, 5-Port

DIGITUS® HDMI Matrix Switch, 4 x 2-Port

The convenient and complete HDMI distributing solution for Home Entertainment

This HDMI Matrix Switch combines the advantages of an ordinary HDMI switch and a HDMI splitter. It routes one or two HDMI video signals from four available inputs to one or two selectable HDMI displays. This offers highest versatility for all integrated systems. All inputs are adapted for high definition video sources like HD-DVD, receivers, set-top boxes, game consoles, etc.

- Switch easily between any of up to four HDMI sources
- Distributes any of the four inputs to any or any combination of the two HDMI output displays
- Multi-switching methods: intelligent automatic, IR remote control or by touch button
- Highest supported video resolution 1080p
- Compatible to High Speed HDMI (1.3b)
- Bandwidth: 225MHz/2.25Gbps per channel(6.75Gbps all channel)
- Supports 12bit per channel (36bit all channel) deep color
- Supports HDCP
- Supports uncompressed audio such as LPCM
- Supports compressed audio such as DTS Digital, Dolby Digital (including DTS-HD and Dolby True HD)
- Dimensions (DxWxH; Weight): 128x220x25mm; 350g

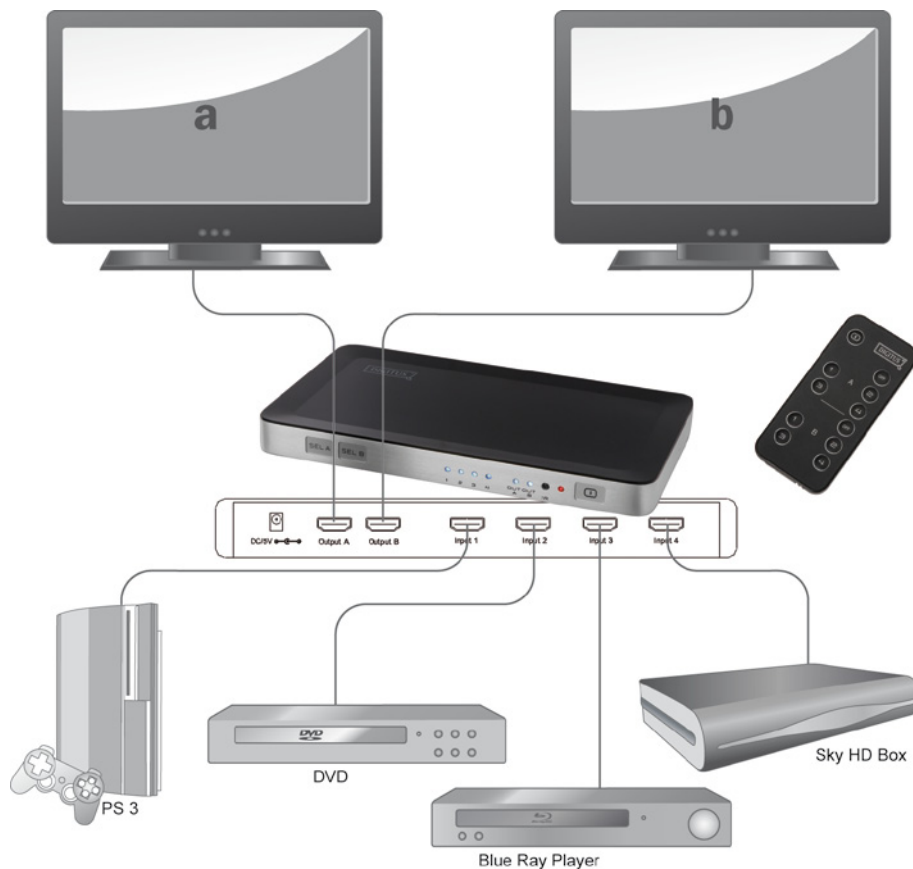

Fast Switching Home Entertainment System

Turn your home theatre into an inimitably adventure!

This 4 x 1-Port HDMI Switch with HEAC offers high speed switching between 4 HDMI sources without the need to redo the HDCP authentication. Besides, it provides you with 3D function as well as HEC and ARC splitting (HDTV to Ethernet and HDTV to Coaxial, Toslink or Stereo Audio signals) thanks to the built-in HDMI Ethernet and Audio Return Channel.

- 4 HDMI inputs and 1 HDMI output
- HDMI 1.4a with HEAC, 3D, CEC
- Built-in HDCP engine for Instant Port Switching (IPS)
- Highest video resolution 1080p
- Supports 225MHz/2.25Gbps per channel (6.75Gbps all channel) bandwidth and 12bit per channel (36bit all channel) deep color
- Supports 3D all format, including 1080p@23.98/24Hz, 720p@59.94/60Hz/50Hz, bandwidth up to 225MHz
- Compressed audio formats like DTS Digital, Dolby Digital (including DTS-HD and Dolby True HD) and uncompressed audio formats such as LPCM
- Supports digital audio Toslink and COAX output simultaneously as well as Stereo audio output from source device (connection to Amplifier via ARC)
- No software or driver installation required
- Compatible with most commonly used operating systems like DOS, Windows 98SE/ME/2000/XP/2003 Server/Vista/7, Mac OS9/OSX and Sun Microsystems



310075 / DS-45320
4 x 1-Port HDMI switch

DIGITUS® HDMI pocket video splitter , 2-port

One of the smallest HDMI Video Splitter! Display one video signal on two different HDTV monitors!

With the DIGITUS® pocket HDMI splitter you can supply two HDMI displays from only one HDMI device.

- 1 input, 2 outputs
- Easy to install and simple to operate
- Supports a distance of up to 15m
- Compatible with HDTV 480i, 480p, 720i, 720p, 1080i and 1080p
- Supports VGA, SVGA, XGA and UXGA
- HDMI High Speed (1.3b) and HDCP compatible
- Operation pixel frequency range: 25-225MHz



276586 / DS-41302
Pocket HDMI splitter, 2-port

DIGITUS® Automatic HDMI Switch, 2-Port

Automatic switching between two HDMI sources.

With the automatic DIGITUS® HDMI switch you can supply one HDMI display from two HDMI devices. Switching will be done by itself automatically and take the latest presented device port as the current signal port or manually.

- 2 inputs, 1 output
- Easy to install and simple to operate - automatic switching
- Plug & Play - No software required
- HDCP compliant
- Compatible with HDTV 480i, 480p, 720i, 720p, 1080i and 1080p
- Supports VGA, SVGA, XGA and UXGA
- HDMI High Speed compatible
- Supports for 8bit, and 12bit deep color per channel



271581 / DS-44302
HDMI Automatic switch, 2-port

DIGITUS® HDMI Repeater

Extends the HDMI signals up to 50m - ideal for digital signage

HDMI Repeater for up to 50m.

- Video resolution up to 1080p
- HDMI High Speed compatible
- HDCP pass through
- Video bandwidth 1.65Gbps/:



271598 / DS-55900

HDMI Repeater

269014 / DS-55901

Professional HDMI Repeater

DIGITUS® HDMI Video extender

Easy and convenient distribution for HDMI signals - Place your displays wherever you want without HDMI cable limitations

Extends the max. length of HDMI cable up to 50M by using a simple network cable between a transmitter and a receiver unit.

- Cat 5 HDMI extender consisting of transmitter and receiver unit
- Video resolution up to 1080p
- For extension up to 50 meter
- Follow the standard of IEEE-568B
- Bandwidth 165MHz/1.65Gbps per channel (4.95Gbps all channel)
- Deep color 8bit per channel (24bit all channel)
- HDCP pass through
- Auto-adjustment of feedback, equalization and amplify
- Support uncompressed audio such as LPCM



277774 / DS-55100

HDMI Video extender, Cat5/6

HDMI Video Extender with POE

Full HD and 3D Support

The DIGITUS HDMI Video Extender transmits digital video and audio signals up to 330 feet (100 meters) using one CAT5e/6 cable. Each video extender consists of a local unit that connects to an HDMI source and optional IR Transmitter, and a remote unit that connects to an HDMI display and optional IR receiver. It also provides POE function that you only need one power adapter at the end of the transmitter to supply the power both the end of the transmitter and receiver.

- Extends the max. length of HDMI cable up to 100M by using a simple network cable between a transmitter and a receiver unit.
- Cat 5 HDMI extender consisting of transmitter and receiver unit
- Video resolution up to 1080p
- For extension up to 100 meter
- Optional support for Infrared Remote (IR) control
- Deep color 12bit per channel (36bit all channel)
- Bandwidth 340MHz/3.4Gbps per channel (10.2Gbps all channel)
- HDCP pass through
- 3D pass through
- CEC pass through
- Support uncompressed audio such as LPCM
- Support POE (Power over Ethernet)
- Support compressed audio such as DTS Digital, Dolby Digital (including DTS-HD and Dolby True HD)
- Powered from a single power supply
- Follow the standard of IEEE-568B



309444 / DS-55400

HDMI Video extender, Cat5/6

DIGITUS® Multimedia VGA/Audio to HDMI Converter



Shows a VGA video signal on a HDMI display, like your home TV
 Converts VGA input into HDMI and allows PC users to enjoy their image on HDMI TV. The conversion is along with the stereo audio. It offers solutions for digital entertainment center, HDTV, STB, DVD, Projectors and many more.

- Converts PC's VGA video and stereo audio signals into a HDMI compliant signal
- Suitable for video resolutions up to 1280x1024 pixel
- Bandwidth 165MHz/1.65Gbps per channel (6.75Gbps all channel)
- Color depth 8bit per channel (24bit all channel)
- Supports HDCP
- Dimensions (LxWxH; weight): 88 x 68 x 25.5mm; 68g

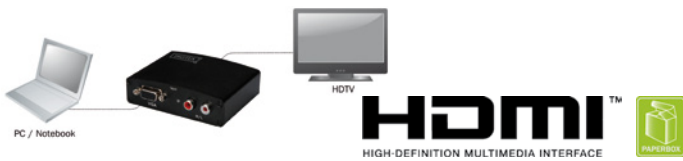

268994 / DS-40130
 Multimedia VGA/Audio to HDMI Converter

Multimedia DVI/Audio to HDMI Converter



Combines digital video (DVI) and analog audio into one HDMI signal

Converts DVI and analog audio input into HDMI and allows users to enjoy and to seamlessly integrate their image into the modern home theaters by meeting the ideal image of the HDMI HDTV. The conversion is along with the stereo audio. It offers solutions for digital entertainment center, HDTV, STB, DVD, Projectors and many more.

- Converts DVI video and R/L audio into complete HDMI
- Video resolutions up to 1080p
- Bandwidth 225MHz/2.25Gbps per channel (6.75Gbps all channel)
- Deep color 12bit per channel (36bit all channel)
- HDCP 1.2 compatible
- Dimensions (LxWxH; Weight): 88x68x25.5mm; 68g
- HDMI Standard Highspeed HDMI
- HDTV Resolution max. 1920 x 1080 Pixel, 60Hz

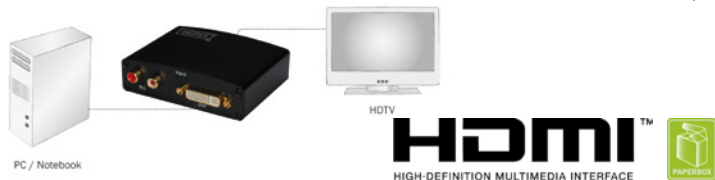

287346 / DS-40230
 Multimedia DVI/Audio to HDMI Converter

DIGITUS® Multimedia HDMI to VGA/Audio Converter



Shows a HDMI video signal on a VGA display and offers separate audio

Converts HDMI input into one VGA and one audio signal and allows users to use modern players also with older VGA displays. The conversion is along with the stereo audio, too. It offers solutions for digital entertainment center, HDTV, STB, DVD, Projectors and many more.

- Converts a HDMI signal into VGA video and R/L audio complete (2 channels LPCM)
- Video resolutions up to UXGA (1600x1200 pixel) and 1080p
- Bandwidth 165MHz/1.65Gbps per channel (6.75Gbps all channel)
- HDCP 1.2 compatible
- Dimensions (LxWxH; weight): 88 x 68 x 25.5mm; 68g



283881 / DS-40310
 Multimedia HDMI to VGA/Audio Converter



**Enjoy connections.
 Live.**

DIGITUS® DVI video / audio splitter



Supports max. resolution of up to 1920x1200 pixels

With a DVI video/audio splitter it is possible to display a signal from a DVI video source on several monitors/speakers.

- DVI video/audio splitter, 2-port
- Supports max. resolution up to 1920x1200 pixels and Full HD 1080p
- Automatic power-save when Video input is lost
- Crisp clear video images
- LED indicators for signal activity monitoring
- Support EDID, HDCP and is Blu-ray ready
- Cascadable
- Input and Output connections: DVI-Female
- Dimension (DxWxH; Weight): 20x180x85mm; 600g



286356 / DS-41211

DVI video/audio splitter, 2 port

286363 / DS-42211

DVI video/audio splitter, 4-port

286370 / DS-43211

DVI video/audio splitter, 8-port

DIGITUS® DVI repeater, 50m



Boosts your DVI video signal up to a distance of 50m

The compact DVI repeater extends the possible transmission distance of any DVI-D signal up to a length of 50m to reach projectors or monitors. It automatically equalizes and compensates cables losses.

- DVI line amplifier extends digital video up to 50 meters
- Maintains multiple high definition resolutions up to 1080p or 1920 x 1200 for computers
- Video bandwidth 1.65Gbps/165MHz
- INPUT/OUTPUT connector: DVI-D female
- Easy to use, just Plug and Play



285687 / DS-54901

DVI repeater, 50m

DIGITUS® DVI / Audio switch



Easy and convenient video / audio source selection

The DVI video / audio switch allows choosing and displaying one DVI video signal out of several video sources.

- Several inputs (e.g. PC), 1 output (Monitor, Beamer etc.)
- Fully compliant with DVI-Digital
- Supports resolution up to 1920x1200 pixel or 1080p
- Audio enabled
- Source selection via front panel pushbuttons or IR remote control
- Ideal for school classes, workshops, training rooms, etc.
- DDC, DDC2, DDC2B support
- HDCP Support



286387 / DS-44211

DVI / Audio switch, 2 inputs, 1 output

286394 / DS-45211

DVI / Audio switch, 4 inputs, 1 output

DVI extender over CAT5



Extension of DVI signal up to 70 meter

The DVI CAT5 extender extends your PC DVI transmission distance up to 70 meters through a simple Cat5 cable. The possible resolutions depend on the extended distance.

- DVI-D extension over Cat5 cable
- Supports max. resolution up to 1920x1200 pixels at a distance of 50m
- Supports max. distance up to 70m at a resolution of 800x600 pixels
- No external power supply needed



285694 / DS-54101

DVI extender over CAT5; single port

DIGITUS® VGA splitter 300MHz

Provides simultaneous display on two different monitors - Perfect for classrooms, tradeshows, or in-store displays

Using a video splitter you can use one video source to display identical images on 2, 4, 8, or 16 monitors - or on even more screens by means of cascading. Thus, a video splitter can be used in various application fields, e.g. test bench facilities, data centers, help desks, video broadcasting, presentations and educational facilities.

- Video bandwidth: 300MHz
- Maximum resolution 1920x1440 pixels at 60Hz
- Built-in line amplifier, up to 65m
- DDC, DDC2, DDC2B support
- Cascadable (max. 64)
- Metal housing for better EMI shielding
- Video IN: 1x HD DSUB, 15-pin, plug
- Video OUT: 2x HD DSUB, 15-pin, jacks



255604 / DC-41100

VGA splitter 300MHz, 2-port

255611 / DC-42100

VGA splitter 300MHz, 4-port

255628 / DC-43100

VGA splitter 300MHz, 8-port

DIGITUS® VGA splitter 400MHz

Provides simultaneous display on two different monitors - Perfect for classrooms, tradeshows, or in-store displays

Using a video splitter you can use one video source to display identical images on 2, 4, 8, or 16 monitors - or on even more screens by means of cascading. Featuring a video bandwidth of 400MHz and a consequently high video resolution these video splitters can ideally be used in various application fields, e.g. test bench facilities, data centers, help desks, video broadcasting, presentations, and educational facilities.

- Video bandwidth: 400MHz
- Maximum resolution 2048x1536 pixels at 60Hz
- Built-in line amplifier, up to 65m
- DDC, DDC2, DDC2B support
- Cascadable (max. 64)
- Metal housing for better EMI shielding
- Video IN/OUT: HD DSUB, 15-pin, jacks



255635 / DC-41110

VGA splitter 400MHz, 2-port

255642 / DC-42110

VGA splitter 400MHz, 4-port

255659 / DC-43110

VGA splitter 400MHz, 8-port

255666 / DC-43115

VGA splitter 400MHz, 16-port

DIGITUS® pocket video splitter 300MHz

Easily broadcast one video signal up to two monitors

This video splitter allows you to use one PC to display identical images at the same time on 2, 4 or even more monitors.

- Featuring 300MHz pixel frequency
- Extends video signal up to 65 meters (213 feet)
- DDC, DDC2, DDC2B support
- Can be cascaded
- Compatible with standard VGA card
- Maximum resolution 2048x1536 pixels at 60Hz
- Signals: VGA, SVGA, XGA, QXGA, UXGA Multisync
- Incl. power supply unit DC 9V 600mA
- Dimensions (L x W x H, weight): 100mm x 81.5mm x 27.5mm, 94g

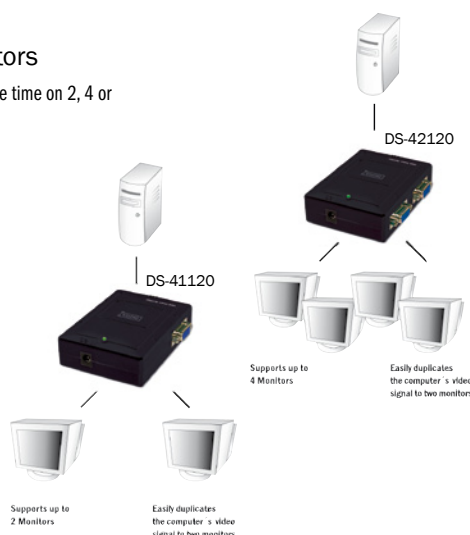

258216 / DS-41120

VGA splitter 300MHz, 2-port

258223 / DS-42120

VGA splitter 300MHz, 4-port

DIGITUS® VGA selector 250MHz

Easy and convenient video source selection by push button

A video selector allows you to choose and display one video signal out of several video sources.

- 2 inputs (PC), 1 output (monitor, beamer, etc.)
- Ideal for school classes, workshops, training rooms, etc.
- Maximum resolution 1920x1440 pixels at 60Hz
- Video bandwidth: 250MHz
- DDC, DDC2, DDC2B support
- Video input connections: HDSUB15/female
- Video output connection: HDSUB15/female
- Dimensions (L x W x H, weight): 128mm x 75mm x 45mm, 400g



258230 / DS-44100

Video selector 250MHz, 2 inputs, 1x output

258247 / DS-45100

Video selector 250MHz, 4 inputs, 1x output

258254 / DS-46100

Video selector 250MHz, 8 inputs, 1x output

DIGITUS® VGA Matrix splitter, 250MHz

The convenient and complete video signal distributing solution

With this video matrix splitter it is possible to choose one video signal from two video sources and to display the signal on several monitors.

- 2 switchable inputs (PC), 2 outputs (monitor)
- Built-in line amplifier, up to 65m
- Maximum resolution 1920x1440 pixels at 60Hz
- Video bandwidth: 250MHz
- DDC, DDC2, DDC2B support
- Cascadable
- Video input connections: HDSUB15/female
- Video output connections: HDSUB15/female
- Dimensions (L x W x H, weight): 130mm x 75mm x 42mm, 420g



279327 / DS-47110-1

VGA Video matrix, 2 inputs, 2 outputs

279334 / DS-48110-1

VGA Video matrix, 2 inputs, 4 outputs

258285 / DS-49110

VGA Video matrix, 2 inputs, 8 outputs

DIGITUS® Video/audio matrix

Ideal for distributing video in classrooms, at exhibits, trade shows, demonstrations, and for multi-media presentations

Using a Video/Audio Matrix you can display / play images / audio signals on up to 4 screens / speakers (or earphones) using 2 different PCs. It is also possible to control the sources of images / sounds by selecting the computer's signal sources 1 or 2, or to turn off source inputs. This Intelligent Video/Audio Matrix can ideally be used in various application fields, e.g. test bench facilities, data centers, help desks, video broadcasting, presentations, stock quotes, timetables, educational facilities, etc.

- Intelligent functionality
- Can be cascaded
- Featuring 250MHz video bandwidth, suitable for DDC, DDC2, DDC2B
- Supports VGA, SVGA, UXGA, QXGA resolutions
- Can be used for Multi-Sync video types, including RGBHV, RGsB, RGBS
- Supports synchronizations, positive & negative; TTL or 1Vpp level
- VGA outputs compatible with standard VGA cards
- Extends video signal up to 65 meters (213 feet)
- Audio Frequency Response 20Hz~20KHz
- Using the switches on the front side you can turn on/off video signal sources and output signals (Out/All).
- Dimensions (L x W x H, weight): 130mm x 75mm x 42mm, 450g



255697 / DC-47100

Video/audio matrix 2x2

255703 / DC-47101

Video/audio matrix 2x4

DIGITUS® Video/Audio Matrix

Ideal for distributing video in classrooms, at exhibits, trade shows, demonstrations, and for multi-media presentations

Through the video/audio matrix DC-48101, you can display / play different images / audio signals to 4 screens / speakers (or earphones) through 4 PC. And you can also control the source of image / audio by selecting PC signal source 1 ~ 4 or turning off source input. Video/Audio matrix is ideal for ,test bench facilities, data center, help desks, video broadcasting, presentation, stock quotes, timetables, educational facilities, etc.

- Intelligent functionality
- Can be cascaded
- With 350 MHz pixel frequency, supports DDC, DDC2, DDC2B
- Supports VGA, SVGA, UXGA, QXGA resolutions
- Support Multi-Sync video type include RGBHV, RGsB, RGBS
- Support synchronous Include positive, negative; TTL or 1Vpp level
- Four sets of 7-Segment LED can indicate the input setting status of input port quickly
- The output is compatible with standard VGA card
- Extends the video signal up to 65 meter (213 feet)
- The switches on panel can select PC signal source 1 ~ 4 as OUT 1 ~ 4 or turning off any signal I/O port / all I/O ports



233350 / DC-48101
Matrix switch 4x4

DIGITUS® VGA booster, 65m

VGA booster, 65m

Boost a video signal in a way that the transmission is possible up to a distance of 65m.

- VGA line amplifier, up to 65m
- Maximum resolution 1920x1440 pixels at 60Hz
- Video bandwidth 300 MHz
- DDC, DDCB, DDC2B support
- Cascadable
- Video IN: HDSUB15/Male
- Video OUT: HDSUB15/Female
- Incl. power supply
- Dimensions (LxWxH; Weight): 97x56x26mm; 80g



285366 / DS-53900-1
VGA booster, 65m

DIGITUS® VGA extender over CAT5

Uses simple Ethernet cable to extend VGA displays

Through the VGA Extender, you can use one PC to display identical image and extension of VGA signal up to various meter on monitor.

- VGA extension over CAT 5 cable
- Distance up to 80m between PC and monitor
- Video resolution up to 1280x1024 pixels at 60Hz
- Connection of one remote display
- Equalization length is adjustable
- VGA signal gain is adjustable



255710 / DC-53100
VGA extender, 80m, single port

223894 / DC-53101
VGA extender, 180m, single port

223900 / DC-53401
VGA extender, local and remote port

DIGITUS® USB 2.0 connection cable, A/M - A/M, premium

Gold plated connectors and a high screening gage allow a reliable and quick connection of external USB devices with the PC, also about longer distances.

For connection of external USB devices (with A socket) to the USB Host (e. g. PC, Notebook or USB Hub). Datatransferrate up to 480 Mbps (High-Speed).

- Connector 1 USB A, plug
- Connector 2 USB A, plug
- USB compliance USB 2.0
- UL certified UL2725
- Hoods molded
- Shielding double shielding
- AWG 24/28
- Wire material CU
- Connector surface gold-plated
- Ferrite filter none
- Color cable black
- Color connector black/grey



Bulk	DIGITUS Polybag		DIGITUS Blister	
Auf Anfrage	DK-300118-010-D	1,0 m	DB-300118-010-D	1,0 m
	DK-300118-018-D	1,8 m	DB-300118-018-D	1,8 m
	DK-300118-030-D	3,0 m	DB-300118-030-D	3,0 m
	DK-300118-050-D	5,0 m	DB-300118-050-D	5,0 m

DIGITUS® USB 2.0 connection cable, A/M - B/M, premium

Gold plated connectors and a high screening gage allow a reliable and quick connection of external USB devices with the PC, also about longer distances.

For connection of external USB devices (with B socket, e. g. external HDD enclosure, scanner or printer) to the USB Host (e. g. PC, Notebook or USB Hub). Datatransferrate up to 480 Mbps (High-Speed).

- Connector 1 USB A, plug
- Connector 2 USB B, plug
- USB compliance USB 2.0
- UL certified UL2725
- Hoods molded
- Shielding double shielding
- AWG 24/28
- Wire material CU
- Connector surface gold-plated
- Ferrite filter none
- Color cable black
- Color connector black/grey

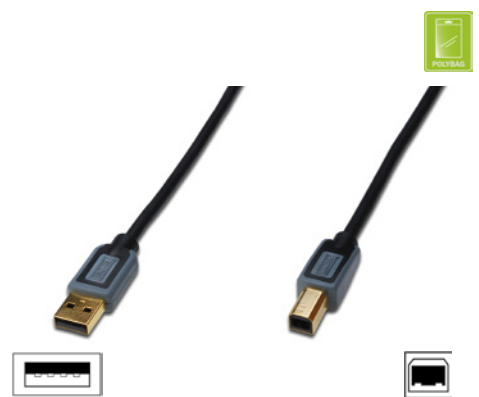

Bulk	DIGITUS Polybag		DIGITUS Blister	
Auf Anfrage	DK-300119-010-D	1,0 m	DB-300119-010-D	1,0 m
	DK-300119-018-D	1,8 m	DB-300119-018-D	1,8 m
	DK-300119-030-D	3,0 m	DB-300119-030-D	3,0 m
	DK-300119-050-D	5,0 m	DB-300119-050-D	5,0 m

DIGITUS® USB 2.0 connection cable, A/M - miniB(5pin)/M

Gold plated connectors and a high screening gage allow a reliable and quick connection of external USB devices with the PC, also about longer distances.

For connection of external USB devices (with mini B (5-pin) socket, e. g. MP3-Player, Handy or external HDD enclosure) to the USB Host (e. g. PC, Notebook or USB Hub). Datatransferrate up to 480 Mbps (High-Speed).

- Connector 1 USB A, plug
- Connector 2 Mini USB B, 5-pin, plug
- USB compliance USB 2.0
- UL certified UL2725
- Hoods molded
- Shielding double shielding
- AWG 24/28
- Wire material CU
- Connector surface gold-plated
- Ferrite filter none
- Color cable black
- Color connector black/grey



Bulk	DIGITUS Polybag		DIGITUS Blister	
Auf Anfrage	DK-300121-010-D	1,0m	DB-300121-010-D	1,0m
	DK-300121-018-D	1,8m	DB-300121-018-D	1,8 m
	DK-300121-030-D	3,0m	DB-300121-030-D	3,0 m
	DK-300121-050-D	5,0m	DB-300121-050-D	5,0 m

DIGITUS® USB 2.0 connection cable, A/M - microB/M, premium

Gold plated connectors and a high screening gage allow a reliable and quick connection of external USB devices with the PC, also about longer distances.

For connection of external USB 2.0 devices (with USB micro B socket, e. g. external HDD enclosure, MP3-Player or Handy) to the USB Host (e. g. PC, Notebook or USB Hub). Datatransferrate up to 5 Gbps (Super-Speed).

- Connector 1 USB A, plug
- Connector 2 Micro USB B, plug
- USB compliance USB 2.0 conform
- UL certified UL2725
- Hoods molded
- Shielding double shielding
- AWG 24/28
- Wire material CU
- Connector surface gold-plated
- Ferrite filter 2 x ferrite beads
- Color cable black
- Color connector black/grey



Bulk	DIGITUS Polybag		DIGITUS Blister	
Auf Anfrage	DK-300126-010-D	1,0m	DB-300126-010-D	1,0m
	DK-300126-018-D	1,8m	DB-300126-018-D	1,8 m
	DK-300126-030-D	3,0m	DB-300126-030-D	3,0 m
	DK-300126-050-D	5,0m	DB-300126-050-D	5,0 m

DIGITUS® USB 2.0 extension cable, A/M - A/F, premium

Gold plated connectors and a high screening gage allow a reliable and quick connection of external USB devices with the PC, also about longer distances.

For extension of USB cables or devices (with USB A plug). Datatransferrate up to 480 Mbps (High-Speed).

- Connector 1 USB A, plug
- Connector 2 USB A, jack
- USB compliance USB 2.0
- UL certified UL2725
- Hoods molded
- Shielding double shielding
- AWG 24/28
- Wire material CU
- Connector surface gold-plated
- Ferrite filter none
- Color cable black
- Color connector black/grey



Bulk	DIGITUS Polybag		DIGITUS Blister	
Auf Anfrage	DK-300207-018-D	1,8m	DB-300207-018-D	1,8 m
	DK-300207-030-D	3,0m	DB-300207-030-D	3,0 m
	DK-300207-050-D	5,0m	DB-300207-050-D	5,0 m

USB Dockingstation with extension cable, A/M - A/F

The dense screening allows a reliable and fast connection of external USB devices with the PC, also about longer distances.

For an easy and stable USB access on your table. Especially for USB devices (with USB A plug) which must be connected in straight position. Datatransferrate up to 480 Mbps (High-Speed).

- Connector 1 USB A, plug
- Connector 2 USB B, plug
- USB compliance USB 2.0
- UL certified UL2725
- Hoods molded
- Shielding double shielding
- AWG 28
- Wire material CU
- Connector surface nickel-plated
- Ferrite filter none
- Color cable black
- Color connector black



Bulk	DIGITUS Polybag	DIGITUS Blister
Auf Anfrage	Auf Anfrage	DB-300204-015-S 1,5 m

DIGITUS® USB 2.0 Docking Ball

Place the docking ball on a easy to reach position, so you can always use two USB ports. The top connection is for DATA, to connect a USB flash drive, card reader, Wireless Lan USB Adapter or other USB devices. The front connection is only power, this can be used for charging a smartphone, connecting an USB fan or other USB gadgets.

- Allows easy access to USB ports
- Moves the USB port from the back of the computer to your desktop or computer case
- Cable length: 1,8m



Bulk	DIGITUS Polybag	DIGITUS Blister
Auf Anfrage	Auf Anfrage	DB-300205-015-S

DIGITUS® VGA monitor connection cable, HD15/M to HD15/M, premium

Fulfills high demands to the image quality by gold plated contacts and a double shielding.

For connection of a PC, for example, with a Monitor or Beamer/Projector.

- Connector 1 HD DSUB, 15-pin, plug
- Connector 2 HD DSUB, 15-pin, plug
- Cable type 3Coax + 4-wire
- UL certified UL20276
- Display Data DDC2
- Hoods molded
- Shielding double shielding
- AWG 28
- Wire material CU
- Ferrite filter none
- Connector surface gold-plated
- Color cable black
- Color connector black/grey



Bulk	DIGITUS Polybag	DIGITUS Blister
Auf Anfrage	DK-310104-018-D 1,8m	DB-310104-018-D 1,8m
	DK-310104-030-D 3,0m	DB-310104-030-D 3,0m
	DK-310104-050-D 5,0m	DB-310104-050-D 5,0m

DIGITUS® VGA monitor connection cable, HD15/M to HD15/M, premium

Satisfies the highest demands to the image quality by gold plated contacts, ferrites and a triple shielding.

For connection of a PC, for example, with a Monitor or Beamer/Projector.

- Connector 1 HD DSUB, 15-pin, plug
- Connector 2 HD DSUB, 15-pin, plug
- Cable type 3Coax + 9-wire
- UL certified non UL
- Display Data DDC2
- Hoods molded
- Shielding double shielding
- AWG 28
- Wire material CU
- Connector surface gold-plated



Bulk	DIGITUS Polybag	DIGITUS Blister
Auf Anfrage	DK-310105-018-D 1,8m	DB-310105-018-D 1,8 m
	DK-310105-030-D 3,0m	DB-310105-030-D 3,0m
	DK-310105-050-D 5,0m	DB-310105-050-D 5,0m
	DK-310105-100-D 10,0m	
	DK-310105-150-D 15,0m	
	DK-310105-200-D 20,0m	

DIGITUS® VGA Monitor extension cable, HD15/M - HD15F, premium

Fulfills high demands to the image quality by gold plated contacts and a double shielding.

For extension of Monitor cables or devices (with HD15 plug), for example, PC, Monitor or Beamer/Projector.

- Connector 1 HD DSUB, 15-pin, plug
- Connector 2 HD DSUB, 15-pin, jack
- Cable type 3Coax + 4-wire
- UL certified non UL
- Display Data DDC2
- Hoods molded
- Shielding double shielding
- AWG 28
- Wire material CU
- Connector surface gold-plated
- Ferrite filter none
- Color cable black
- Color connector black/grey



Bulk	DIGITUS Polybag	DIGITUS Blister
Auf Anfrage	DK-310204-018-D 1,8m	DB-310204-018-D 1,8m
	DK-310204-030-D 3,0m	DB-310204-030-D 3,0m
	DK-310204-050-D 5,0m	DB-310204-050-D 5,0m

DIGITUS® VGA Monitor extension cable, HD15/M - HD15F, premium

Satisfies the highest demands to the image quality by gold plated contacts, ferrites and a triple shielding.

For extension of Monitor cables or devices (with HD15 plug), for example, PC, Monitor or Beamer/Projector.

- Connector 1 HD DSUB, 15-pin, plug
- Connector 2 HD DSUB, 15-pin, jack
- Cable type 3Coax + 9-wire
- UL certified UL2919
- Display Data DDC2
- Hoods molded
- Shielding triple shielding
- AWG 28
- Wire material CU
- Connector surface gold-plated
- Ferrite filter 2 x ferrite beads



Bulk	DIGITUS Polybag	DIGITUS Blister
Auf Anfrage	DK-310205-018-D 1,8m	DB-310205-018-D 1,8 m
	DK-310205-030-D 3,0m	DB-310205-030-D 3,0m
	DK-310205-050-D 5,0m	DB-310205-050-D 5,0m
	DK-310205-100-D 10,0m	DB-310205-100-D 10,0m
	DK-310205-200-D 20,0m	

{DVI connection cable, DVI(18+1)/M to DVI(18+1)/M

HD-Ready, Single Link

This digital, HD Ready suitable DVI cable (Single Link), is used to connect audio/video equipment with DVI(18+1) interface, such as PC, notebook, monitor, TV or a projector, for example.

- Connector 1 DVI-D, (18+1), plug
- Connector 2 DVI-D, (18+1), plug
- Cable type Single-Link
- UL certified UL20276
- HDTV Standard 1080i
- HDTV Resolution 1920 x 1200 Pixel, 60Hz
- Hoods molded
- Shielding triple shielding
- AWG 28
- Wire material CU
- Ferrite filter 2 x ferrite beads
- Connector surface gold-plated



Bulk	DIGITUS Polybag	DIGITUS Blister
Auf Anfrage	DK-320103-020-D 2,0m	DB-320103-020-D amer.
	DK-320103-030-D 3,0m	DB-320103-030-D 3,0m
	DK-320103-050-D 5,0m	DB-320103-050-D 5,0m
	DK-320103-100-D 10,0m	DB-320103-100-D 10,0m

DVI connection cable, DVI(24+1)/M to DVI(24+1)/M

Full HD, Dual Link

This digital, Full HD suitable DVI cable (Dual Link), is used to connect audio/video equipment with DVI(24+1) interface, such as PC, notebook, monitor, TV or a projector, for example.

- Connector 1 DVI-D, (24+1), plug
- Connector 2 DVI-D, (24+1), plug
- Cable type Dual-Link
- UL certified UL20276
- HDTV Standard 1080p
- HDTV Resolution 2560 x 1600 Pixel, 60Hz
- Hoods molded
- Shielding triple shielding
- AWG 28
- Wire material CU
- Ferrite filter 2 x ferrite beads
- Connector surface gold-plated



Bulk	DIGITUS Polybag		DIGITUS Blister	
Auf Anfrage	DK-320104-020-D	2,0m	DB-320104-020-D	2,0m
	DK-320104-030-D	3,0m	DB-320104-030-D	3,0m
	DK-320104-050-D	5,0m	DB-320104-050-D	5,0m
	DK-320104-100-D	10,0m	DB-320104-100-D	10,0m

DVI extension cable, DVI(24+1)/M to DVI(24+1)/F

Full HD, Dual Link

This digital, Full HD suitable DVI cable (Dual Link), is used to extend existing connections of audio/video equipment or cables with DVI(24+1) interface, such as between PC, notebook, monitor, TV or a projector, for example.

- Connector 1 DVI-D, (24+1), plug
- Connector 2 DVI-D, (24+1), jack
- Cable type Dual-Link
- UL certified UL20276
- HDTV Standard 1080p
- HDTV Resolution 2560 x 1600 Pixel, 60Hz
- Hoods molded
- Shielding triple shielding
- AWG 28
- Wire material CU
- Ferrite filter 2 x ferrite beads
- Connector surface gold-plated



Bulk	DIGITUS Polybag		DIGITUS Blister	
Auf Anfrage	DK-320201-020-D	2,0m	DB-320201-020-D	2,0m
	DK-320201-030-D	3,0m		
	DK-320201-050-D	5,0m		
	DK-320201-100-D	10,0m		

DVI adapter cable, DVI(24+5)/M to HD15/M

HD-Ready, Dual Link

This analog, HD Ready suitable DVI cable (Dual Link), is used to connect audio/video equipment with HD15 (VGA) interface, such as PC, notebook, monitor, TV or a projector, for example.

- Connector 1 DVI-I, (24+5), plug
- Connector 2 HD DSUB, 15-pin, plug
- Cable type Dual-Link
- UL certified UL20276
- HDTV Standard 1080p
- HDTV Resolution 2560 x 1600 Pixel, 60Hz
- Hoods molded
- Shielding triple shielding
- AWG 28
- Wire material CU
- Ferrite filter 2 x ferrite beads
- Connector surface gold-plated
- Color cable black
- Color connector black/grey



Bulk	DIGITUS Polybag		DIGITUS Blister	
Auf Anfrage	DK-320301-020-D	2,0m	DB-320301-020-D	2,0m
	DK-320301-030-D	3,0m		
	DK-320301-050-D	5,0m		

HDMI High Speed connection cable, type A/M to type A/M

Full HD and 3D capable

This Full HD (1080p) and 3D suitable cable used for connection of audio/video devices such as Blu-ray player, game pads or consoles, etc., for example, with a TV, Monitor or Computer.

- Connector 1 HDMI type A, plug
- Connector 2 HDMI type A, plug
- HDMI Standard Highspeed HDMI
- Cable type CAT 2
- UL certified UL20276
- HDTV Standard 1080p
- HDTV Resolution 1920 x 1200 Pixel, 60Hz
- Hoods molded
- Shielding triple shielding
- Wire material CU
- AWG 30



Bulk	DIGITUS Polybag		DIGITUS Blister	
Auf Anfrage	DK-330110-010-D	1,0m	DB-330110-010-D	1,0 m
	DK-330110-020-D	2,0m	DB-330110-020-D	2,0 m
	DK-330110-030-D	3,0m	DB-330110-030-D	3,0 m
	DK-330110-050-D	5,0m	DB-330110-050-D	5,0 m
	DK-330110-100-D	10,0m		

HDMI High Speed with Ethernet connection cable, type A/M to type A/M

Full HD and 3D capable + Ethernet connectivity

This Full HD (1080p) and 3D suitable cable used for connection of audio/video devices, such as Blu-ray player, game pads or consoles, etc., for example, with a TV, Monitor or Computer. Also capable for use of any IP-based application.

- Connector 1 HDMI type A, plug
- Connector 2 HDMI type A, plug
- HDMI Standard Highspeed HDMI with Ethernet
- Cable type CAT 2
- UL certified UL20276
- HDTV Standard 1080p
- HDTV Resolution 1920 x 1200 Pixel, 60Hz
- Hoods molded
- Shielding triple shielding
- Wire material CU
- AWG 30
- Ferrite filter none



Bulk	DIGITUS Polybag		DIGITUS Blister	
Auf Anfrage	DK-330112-010-D	1,0m	DB-330112-010-D	1,0 m
	DK-330112-020-D	2,0m	DB-330112-020-D	2,0 m
	DK-330112-030-D	3,0m	DB-330112-030-D	3,0 m
	DK-330112-050-D	5,0m	DB-330112-050-D	5,0 m
	DK-330112-100-D	10,0m		

HDMI adapter cable, type A/M to DVI-D(18+1)/M

HD-Ready, Sinle Link

This HD-Ready (1080i) suitable cable used for connection of audio/video devices with different interfaces such as PC, Notebook, Monitor, TV, game pad or console, etc., for example.

- Connector 1 HDMI type A, plug
- Connector 2 DVI-D, (18+1), plug
- HDMI Standard Highspeed HDMI
- Cable type CAT 2
- UL certified UL20276
- HDTV Standard 1080i
- HDTV Resolution 1920 x 1080 Pixel, 60Hz
- Hoods molded
- Shielding double shielding
- Wire material CU
- AWG 30
- Ferrite filter none



Bulk	DIGITUS Polybag		DIGITUS Blister	
Auf Anfrage	DK-330302-020-D	2,0m	DB-330302-020-D	2,0 m
	DK-330302-030-D	3,0m	DB-330302-030-D	3,0 m
	DK-330302-050-D	5,0m	DB-330302-050-D	5,0 m
	DK-330302-100-D	10,0m	DB-330302-100-D	10,0 m

HDMI adapter cable, type A/M to DVI-D(24+1)/M

Full HD, Dual Link

This Full HD (1080p) suitable cable used for connection of audio/video devices with different interfaces such as PC, Notebook, Monitor, TV, game pad or console, etc., for example.

- Connector 1 HDMI type A, plug
- Connector 2 DVI-D, (24+1), jack
- HDMI Standard Highspeed HDMI
- Cable type CAT 2
- UL certified UL20276
- HDTV Standard 1080p
- HDTV Resolution 1920 x 1200 Pixel, 60Hz
- Hoods molded
- Shielding double shielding
- Wire material CU
- AWG 30
- Ferrite filter none
- Connector surface gold-plated



Bulk	DIGITUS Polybag		DIGITUS Blister	
Auf Anfrage	DK-330303-050-D	5,0m	DB-330303-020-D	2,0 m
	DK-330303-020-D	2,0m	DB-330303-030-D	3,0 m
	DK-330303-030-D	3,0m	DB-330303-050-D	5,0 m



*Enjoy connections.
Live.*



**Please find the complete DIGITUS® assortment
of high quality computer and network accessories online at:
www.digitus.info**